

OWNER'S MANUAL



MAZDA MOTOR CORPORATION

MAZDA3

OWNER'S MANUAL
MAZDA 3

8HC2 Form No. 8HC2-EO-19A

Printed in Japan

MAZDA MOTOR CORPORATION

背幅：(本文 536P+QG48P) × 0.04=23.36mm

Web Owner's Manual

You can view the Web Owner's manual using a Computer, Smartphone, or Tablet.

Please read the Web Owner's manual.

To Customers in Australia

- Please go to the website below.

Interactive Owner's manual

https://owners-manual.mazda.com/gen/en/mazda3/mazda3_8hc2eo19a/index.html



MZD Connect Owner's manual

https://owners-manual.mazda.com/gen/en/mzdconnect/mzdconnect_v1/index.html



Navigation manual

https://owners-manual.mazda.com/gen/en/navi/navi_v1.pdf



To Customers in New Zealand

- Please go to the web site below.

<https://www.mazda.co.nz/services/mazda-parts-manuals>



Limitations on use

- This Web Owner's manual may not display normally depending on the device being used and the contracted services available with the device.
- Communication fees may occur while connected (accessing).
- Access may not be available in poor network or communication environments.

A Word to Mazda Owners

Thank you for choosing a Mazda. We at Mazda design and build vehicles with complete customer satisfaction in mind.

To help ensure enjoyable and trouble-free operation of your Mazda, read this manual carefully and follow its recommendations.

Regular servicing of your vehicle by an expert repairer helps maintain both its roadworthiness and its resale value. A world-wide network of Authorised Mazda Repairers can help you with their professional servicing expertise.

Their specially trained personnel are best qualified to service your Mazda vehicle properly and exactly. Also, they are supported by a wide range of highly specialized tools and equipment specially developed for servicing Mazda vehicles. When maintenance or service is necessary we recommend an Authorised Mazda Repairer.

We assure you that all of us at Mazda have an ongoing interest in your motoring pleasure and in your full satisfaction with your Mazda product.

Mazda Motor Corporation
HIROSHIMA, JAPAN

Important Notes About This Manual

Keep this manual in the glove compartment as a handy reference for the safe and enjoyable use of your Mazda. Should you resell the vehicle, leave this manual with it for the next owner.

All specifications and descriptions are accurate at the time of printing. Because improvement is a constant goal at Mazda, we reserve the right to make changes in specifications at any time without notice and without obligation.

Please be aware that this manual applies to all models, equipment and options. As a result, you may find some explanations for equipment not installed on your vehicle.

©2019 Mazda Motor Corporation
January 2019 (Print1)

How to Use This Manual

We want to help you get the most driving pleasure from your vehicle. Your owner's manual, when read from cover to cover, can do that in many ways.

Illustrations complement the words of the manual to best explain how to enjoy your Mazda. By reading your manual, you can find out about the features, important safety information, and driving under various road conditions.

The symbol below in this manual means “Do not do this” or “Do not let this happen”.



Index: A good place to start is the Index, an alphabetical listing of all information in your manual.

You'll find several WARNINGS, CAUTIONS, and NOTES in the manual.

WARNING

A WARNING indicates a situation in which serious injury or death could result if the warning is ignored.

CAUTION

A CAUTION indicates a situation in which bodily injury or damage to your vehicle, or both, could result if the caution is ignored.

NOTE

A NOTE provides information and sometimes suggests how to make better use of your vehicle.

The following symbol, located on some parts of the vehicle, indicates that this manual contains information related to the part.

Please refer to the manual for a detailed explanation.



Table of Contents

Pictorial Index Interior, exterior views and part identification of your Mazda.	1
Essential Safety Equipment Important information about safety equipment, including seats, seat belt system, child-restraint systems and SRS air bags.	2
Before Driving Use of various features, including keys, doors, mirrors and windows.	3
When Driving Information concerning safe driving and stopping.	4
Interior Features Use of various features for ride comfort, including air-conditioning system and audio system.	5
Maintenance and Care How to keep your Mazda in top condition.	6
If Trouble Arises Helpful information on what to do if a problem arises with the vehicle.	7
Customer Information Important consumer information including warranties and add-on equipment.	8
Specifications Technical information about your Mazda.	9
Index	10

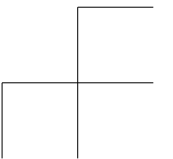
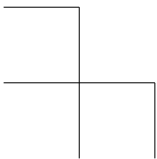
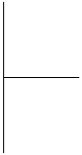
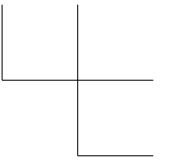
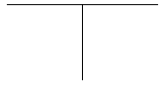
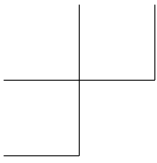

1 Pictorial Index

Interior, exterior views and part identification of your Mazda.

Interior Overview.....	1-2	Exterior Overview.....	1-8
Interior Equipment (View A).....	1-2	(Saloon).....	1-8
Interior Equipment (View B).....	1-3	(Hatchback).....	1-9
Interior Equipment (View C).....	1-4		
Interior Equipment (View D).....	1-5		
Interior Equipment (View E).....	1-6		

Interior Overview

Interior Equipment (View A)

▼ Interior Equipment (View A)

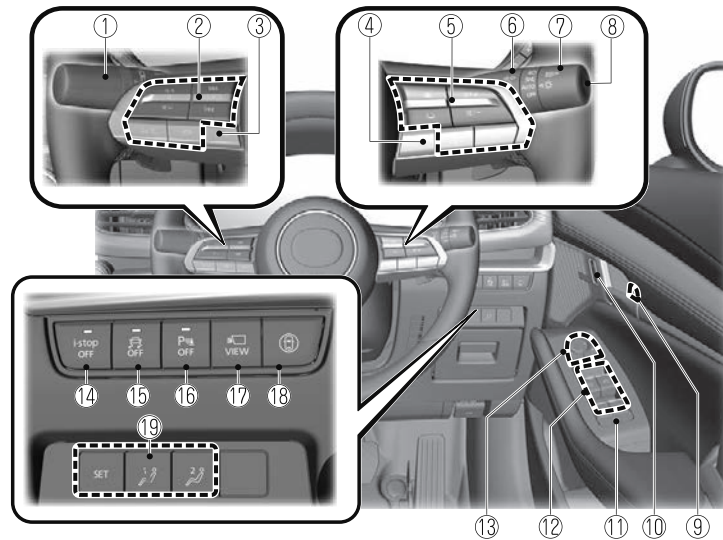

- ① Wiper and washer lever.....page 4-56
- ② Audio remote control switches.....page 5-20
- ③ INFO switch.....page 4-21
- ④ LIM switch.....page 4-158
- ⑤ Cruise control switches.....page 4-124, 4-133, 4-145
- ⑥ Turn and lane-change signals.....page 4-54
- ⑦ Lighting control.....page 4-50
- ⑧ High beam control switch/Adaptive LED headlight switch.....page 4-89, 4-92
- ⑨ Door-lock knob.....page 3-15
- ⑩ Door-lock switch.....page 3-14
- ⑪ Power window lock switch.....page 3-32
- ⑫ Power window switches.....page 3-32
- ⑬ Outside mirror switches.....page 3-27
- ⑭ i-stop OFF switch.....page 4-15
- ⑮ DSC OFF switch.....page 4-78
- ⑯ Parking sensor switch.....page 4-240
- ⑰ 360° view monitor switch.....page 4-182
- ⑱ i-ACTIVSENSE switch.....page 4-85
- ⑲ Position memory buttons.....page 2-11

1-2 The equipment and installation position varies by vehicle

Interior Equipment (View B)

▼ Interior Equipment (View B)

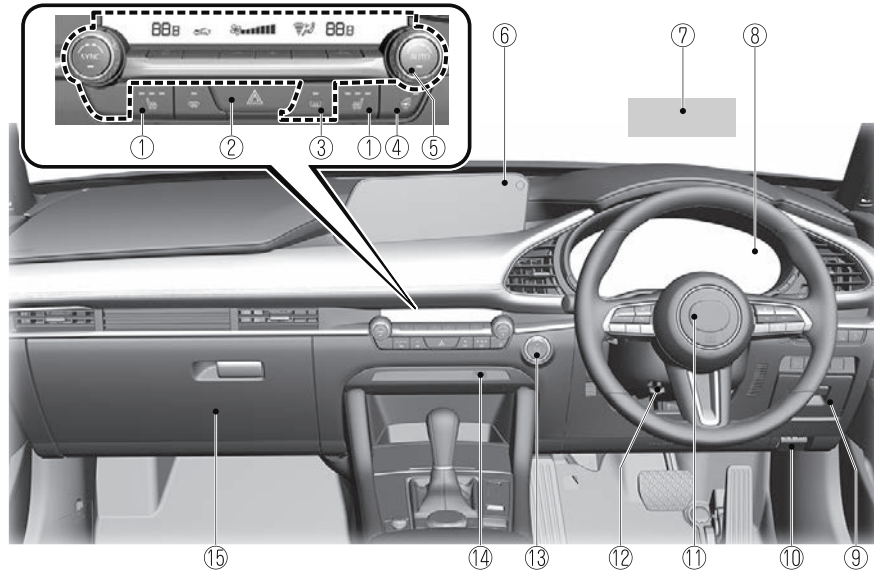

- ① Seat warmer switches.....page 2-20
- ② Hazard warning flasher switch.....page 4-61
- ③ Rear window defogger switch.....page 4-60
- ④ Heated steering wheel switch.....page 2-21
- ⑤ Air-conditioning system.....page 5-2
- ⑥ MZD Connect.....page 5-14
- ⑦ Active driving display.....page 4-35
- ⑧ Instrument cluster.....page 4-19
- ⑨ Storage pocket.....page 5-40
- ⑩ Bonnet release handle.....page 6-9
- ⑪ Horn.....page 4-61
- ⑫ Lock release lever.....page 2-5
- ⑬ Push button start.....page 4-4
- ⑭ External input terminal.....page 5-14
- ⑮ Glove compartment.....page 5-40

The equipment and installation position varies by vehicle **1-3**

Interior Overview

Interior Equipment (View C)

▼ Interior Equipment (View C)

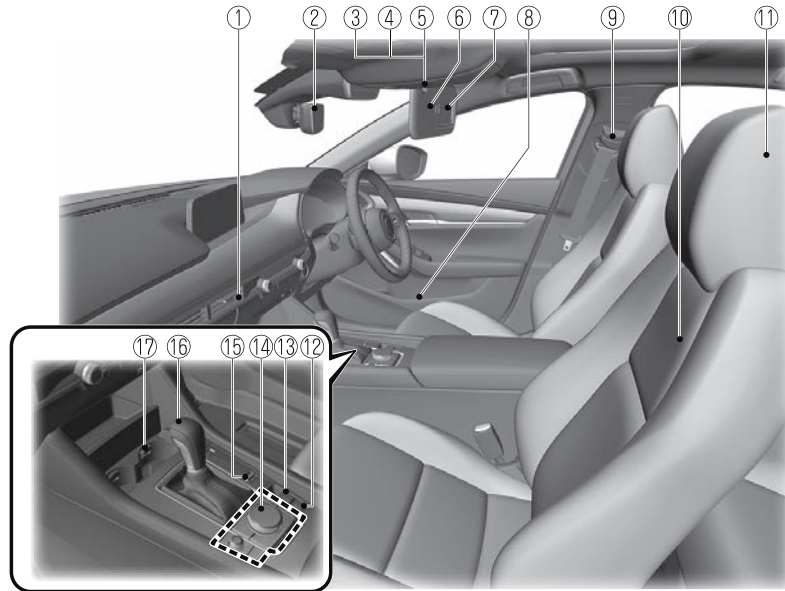

① Vent.....	page 5-3
② Rearview mirror.....	page 3-29
③ Overhead light (front)/Map lights.....	page 5-33
④ Overhead console.....	page 5-40
⑤ Sunroof switch.....	page 3-34
⑥ Sunvisor.....	page 5-32
⑦ Vanity mirror.....	page 5-32
⑧ Bottle holder.....	page 5-38
⑨ Seat belt.....	page 2-23
⑩ Front seat.....	page 2-5
⑪ Head restraint.....	page 2-18
⑫ AUTOHOLD switch.....	page 4-71
⑬ Electric Parking Brake (EPB) switch.....	page 4-64
⑭ Commander switch.....	page 5-17
⑮ Drive selection switch.....	page 4-79
⑯ Shift lever/Selector lever.....	page 4-37, 4-39
⑰ Cup holder.....	page 5-37

1-4 The equipment and installation position varies by vehicle

Interior Equipment (View D)

▼ Interior Equipment (View D)

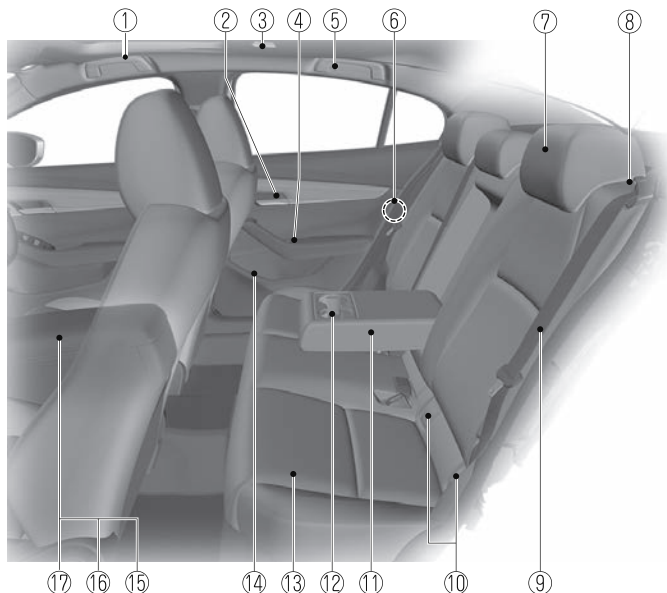

- ① Assist grip.....page 5-39
- ② Door-lock knob..... page 3-15
- ③ Overhead light (rear)..... page 5-33
- ④ Power window switch..... page 3-32
- ⑤ Rear coat hook.....page 5-39
- ⑥ Child safety lock..... page 3-16
- ⑦ Head restraint.....page 2-18
- ⑧ Push knob.....page 2-14
- ⑨ Seat belt.....page 2-23
- ⑩ ISOFIX lower anchors..... page 2-48
- ⑪ Armrest.....page 2-17
- ⑫ Cup holder..... page 5-38
- ⑬ Rear seat..... page 2-14
- ⑭ Bottle holder.....page 5-38
- ⑮ Centre console.....page 5-41
- ⑯ Accessory socket.....page 5-36
- ⑰ External input terminal.....page 5-14

The equipment and installation position varies by vehicle **1-5**

Interior Overview

Interior Equipment (View E)

▼ Saloon

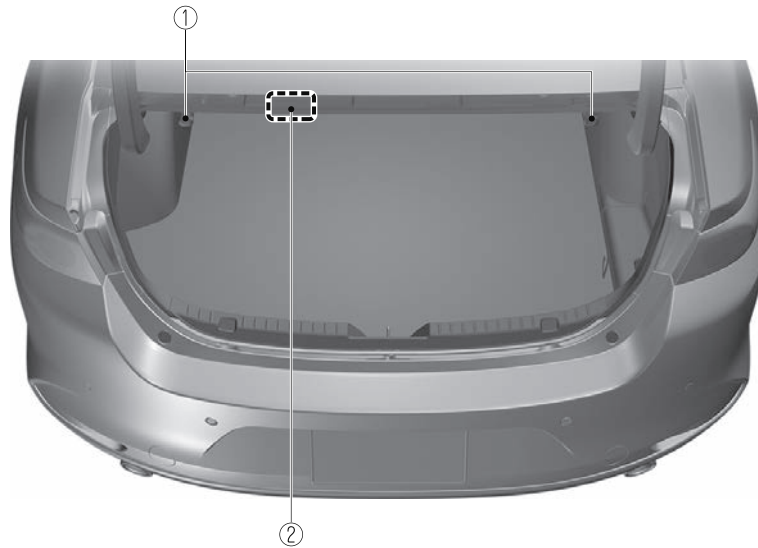

- ① Remote handles.....page 2-14
- ② Boot light.....page 5-33

1-6 The equipment and installation position varies by vehicle

▼ **Hatchback**

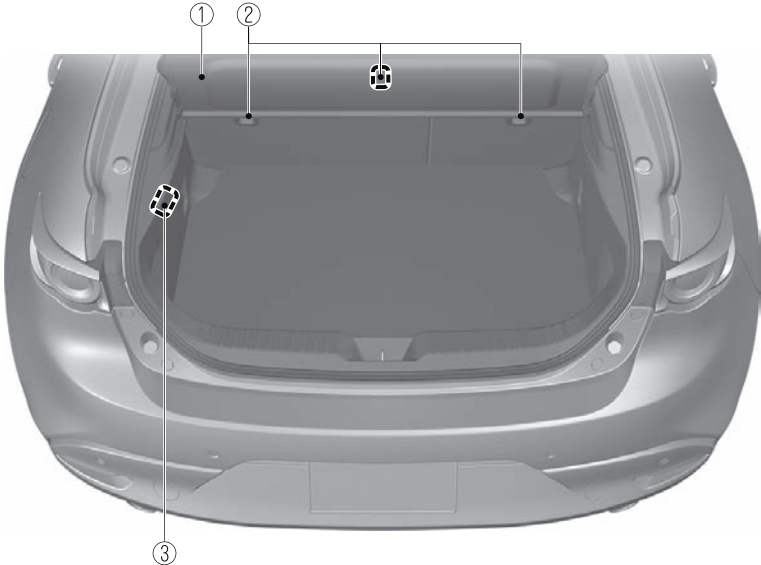

- ① Luggage compartment cover..... page 3-20
- ② Anchor brackets..... page 2-43
- ③ Luggage compartment light..... page 5-33

The equipment and installation position varies by vehicle **1-7**

Exterior Overview

(Saloon)

▼ (Saloon)

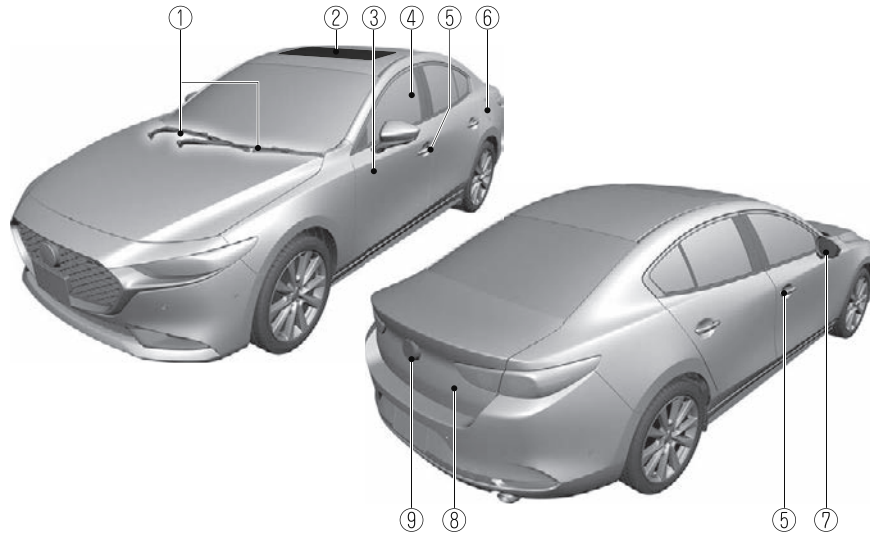

① Windscreen wiper blades.....	page 6-18
② Sunroof.....	page 3-34
③ Door.....	page 3-10
④ Window.....	page 3-31
⑤ Touch sensor.....	page 3-12
⑥ Fuel-filler flap.....	page 3-25
⑦ Outside mirror.....	page 3-27
⑧ Boot lid.....	page 3-17
⑨ Electric boot lid opener.....	page 3-18

1-8 The equipment and installation position varies by vehicle

(Hatchback)

▼ **(Hatchback)**

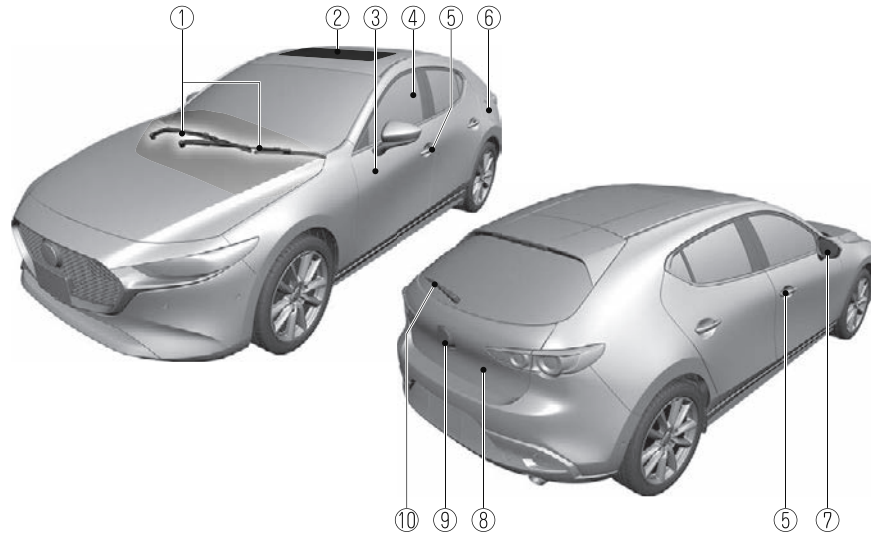

① Windscreen wiper blades.....	page 6-18
② Sunroof.....	page 3-34
③ Door.....	page 3-10
④ Window.....	page 3-31
⑤ Touch sensor.....	page 3-12
⑥ Fuel-filler flap.....	page 3-25
⑦ Outside mirror.....	page 3-27
⑧ Liftgate.....	page 3-17
⑨ Electric liftgate opener.....	page 3-18
⑩ Rear window wiper blade.....	page 6-21

The equipment and installation position varies by vehicle **1-9**

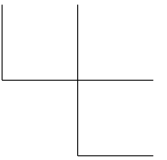
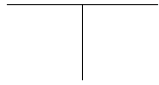
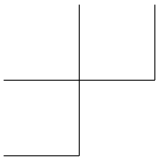

MEMO

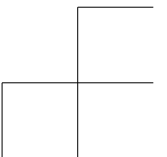
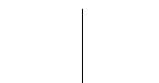
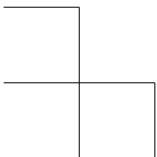
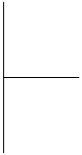

2

Essential Safety Equipment

Important information about safety equipment, including seats, seat belt system, child-restraint systems and SRS air bags.

Seats.....	2-2	SRS Air Bags.....	2-51
Seat Precautions.....	2-2	Supplementary Restraint System	
Front Seat.....	2-5	(SRS) Precautions.....	2-51
Rear Seat.....	2-14	Front Passenger Air Bag	
Head Restraints.....	2-18	Deactivation Switch.....	2-56
Seat Warmer/Heated Steering		Supplementary Restraint System	
Wheel.....	2-20	Components.....	2-58
Seat Warmer*	2-20	How the SRS Air Bags Work.....	2-59
Heated Steering Wheel*	2-21	SRS Air Bag Deployment	
Seat Belt Systems.....	2-23	Criteria.....	2-62
Seat Belt Precautions.....	2-23	Limitations to SRS Air Bag.....	2-64
Seat Belt.....	2-26	Constant Monitoring.....	2-65
Seat Belt Warning Systems.....	2-28		
Seat Belt Pretensioner and Load			
Limiting Systems.....	2-28		
Child Restraint.....	2-31		
Child-Restraint Precautions.....	2-31		
Child-Restraint System			
Installation.....	2-35		
Child-Restraint System Suitability			
for Various Seat Positions			
Table.....	2-40		
Installing Child-Restraint			
Systems.....	2-43		

*Some models. **2-1**

Seats

Seat Precautions

▼ Seat Precautions

WARNING

Make sure the adjustable components of a seat are locked in place:

Adjustable seats and seatbacks that are not securely locked are dangerous. In a sudden stop or collision, the seat or seatback could move, causing injury. Make sure the adjustable components of the seat are locked in place by attempting to slide the seat forward and backward and rocking the seatback.

Never allow children to adjust a seat:

Allowing children to adjust a seat is dangerous as it could result in serious injury if a child's hands or feet become caught in the seat.

Do not drive with the seatback unlocked:

All of the seatbacks play an important role in your protection in a vehicle. Leaving the seatback unlocked is dangerous as it can allow passengers to be ejected or thrown around and baggage to strike occupants in a sudden stop or collision, resulting in severe injury. After adjusting the seatback at any time, even when there are no other passengers, rock the seatback to make sure it is locked in place.

Adjust a seat only when the vehicle is stopped:

If the seat is adjusted while the vehicle is being driven, the seating posture may become unstable and the seat could move unexpectedly resulting in injury.

Do not modify or replace the front seats:

Modifying or replacing the front seats such as replacing the upholstery or loosening any bolts is dangerous. The front seats contain air bag components essential to the supplementary restraint system. Such modifications could damage the supplementary restraint system and result in serious injury. Consult an Authorised Mazda Repairer if there is any need to remove or reinstall the front seats.

Do not drive with damaged front seats:

Driving with damaged front seats, such as seat cushions torn or damaged down to the urethane, is dangerous. A collision, even one not strong enough to inflate the air bags, could damage the front seats which contain essential air bag components. If there was a subsequent collision, an air bag may not deploy which could lead to injuries. Always have an Authorised Mazda Repairer inspect the front seats, front seat belt pretensioners and air bags after a collision.

Do not drive with either front seats reclined:

Sitting in a reclined position while the vehicle is moving is dangerous because you do not get the full protection from seat belts. During sudden braking or a collision, you can slide under the lap belt and suffer serious internal injuries. For maximum protection, sit well back and upright.

Do not place an object such as a cushion between the seatback and your back:

Putting an object such as a cushion between the seatback and your back is dangerous because you will be unable to maintain a safe driving posture and the seat belt cannot function at its full capacity in a collision, which could result in a serious accident, injury or death.

Do not place objects under the seat:

The object could get stuck and cause the seat to not be fixed securely, and result in an accident.

Do not stack cargo higher than the seatbacks:

Stacking luggage or other cargo higher than the seatbacks is dangerous. During sudden braking or a collision, objects can fly around and become projectiles that may hit and injure passengers.

Make sure luggage and cargo is secured before driving:

Not securing cargo while driving is dangerous as it could move or be crushed during sudden braking or a collision and cause injury.

Never allow a passenger to sit or stand on the folded seatback while the vehicle is moving:

Driving with a passenger on the folded seatback is dangerous. Allowing a child to sit up on the folded seatback while the vehicle is moving is particularly dangerous. In a sudden stop or even a minor collision, a child not in a proper seat or child-restraint system and seat belt could be thrown forward, back or even out of the vehicle resulting in serious injuries or death. The child in the baggage area could be thrown into other occupants and cause serious injury.

Never give the car keys to children and do not allow them to play in the vehicle (Saloon):

Playing with the folding rear seats is dangerous. Once the seatbacks are back up, a child in the boot would not be able to get out the way they had entered. If you have small children, keep the seatbacks locked.

Always leave your car locked and keep the car keys safely away from children (Saloon):

Leaving your car unlocked or the keys in reach of children is dangerous. Children who find their way into the boot through an unlocked rear seatback or an open boot can become accidentally locked in the boot. This could result in death or brain damage from heat prostration, particularly in the summer. Always lock the doors and the boot, and as an added measure, keep the rear seatbacks locked, whether you have children in your home or not.

Seats

CAUTION

- *When operating a seat, be careful not to put your hands or fingers near the moving parts of the seat or on the side trim to prevent injury.*
- *When moving the seats, make sure there is no cargo in the surrounding area. If the cargo gets caught it could damage the cargo.*
- **(Manual Seat)**
When moving the seats forward and rearward or returning a rear-reclined seatback to its upright position, make sure you hold onto the seatback with your hand while operating. If the seatback is not held, the seat will move suddenly and could cause injury.
- *When inserting your hand under the seat to clean the cabin or pick up something you dropped under the seat, be careful not to hurt yourself. If you contact the moving parts of the seat rail or seat frame, it could result in injury.*

NOTE

- *When returning a rear seat to its original position, place the seat belt in its normal position. Verify that the seat belt pulls out and retracts.*
- **(Power Seat)**
The seat-bottom power adjustment is operated by motors. Avoid extended operation because excessive use can damage the motors.
 - *To prevent the battery from running down, avoid using the power adjustment when the engine is stopped. The adjuster uses a large amount of electrical power.*

- *Do not use the switch to make more than one adjustment at a time.*

Front Seat

▼ Adjusting the Driver's Seat

Using the driving position set up procedure recommended by Mazda allows you to maintain a relaxed posture, drive the vehicle for longer periods without feeling tired, and make quick operations naturally.

Also, you can be assured of a clear view in the forward direction to help you drive more safely and comfortably.

The adjustments for the driving position recommended by Mazda are done using the following procedures.

1. Moving the steering wheel and seat to their default positions.
2. Adjusting the seatback angle.
3. Adjusting the seat position forward and back.
4. Adjusting the seat height.
5. Adjusting the height on the front edge of the seat bottom.
6. Adjusting the steering wheel position.
7. Adjusting the head restraint position.

Manual seat

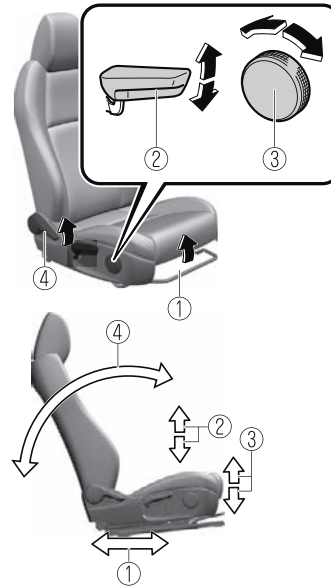

1. **Seat Slide**

To move a seat forward or backward, raise the lever and slide the seat to the desired position and release the lever. Make sure the lever returns to its original position and the seat is locked in place by attempting to push it forward and backward.

2. **Height Adjustment**

To adjust the seat height, move the lever up or down.

3. **Height Adjustment for Front Edge of Seat Bottom**

To adjust the height for front edge of the seat bottom, rotate the dial to the desired position.

Seats

4. Seat Recline

To change the seatback angle, lean forward slightly while raising the lever. Then lean back to the desired position and release the lever.

Make sure the lever returns to its original position and the seatback is locked in place by attempting to push it forward and backward.

Power seat



1. Seat Slide

To slide the seat, move the slide lifter switch on the outside of the seat to the front or back and hold it. Release the switch at the desired position.

2. Height Adjustment

To adjust the seat height, move the slide lifter switch up or down.

3. Height Adjustment for Front Edge of Seat Bottom

To adjust the front height of the seat bottom, raise or lower the front of the slide lifter switch.

4. Seat Recline

To change the seatback angle, press the front or rear side of the reclining switch. Release the switch at the desired position.

5. Lumbar Support Adjustment

To increase the seat firmness, press and hold the front part of the switch to the desired position, then release it. Press the rear part of the switch to decrease firmness.

Before making adjustments to the driving position recommended by Mazda

Before making adjustments, move the steering wheel and seat to their default positions.

How to move the steering wheel to its default position

! WARNING

Never adjust the steering wheel while the vehicle is moving:

Adjusting the steering wheel while the vehicle is moving is dangerous. Moving it can very easily cause the driver to abruptly turn to the left or right. This can lead to loss of control or an accident.

After adjusting the steering wheel position, make sure it is securely locked by trying to move it up and down:

Driving with the steering wheel not securely locked in position is dangerous. If the steering wheel moves unexpectedly while driving, you could lose control of the steering resulting in an accident.

Lower the lever, move the steering wheel to the lowest position, and then push it down and all the way back.



How to move a driver's seat to its default position

1. Slide the seat all the way back.
2. Lower the seat to its lowest height.
3. Lower the front edge of the seat bottom to its lowest height.
4. Sit squarely in the seat and rest your back against the seatback.

Seat adjustment procedure for the driving position recommended by Mazda

Adjusting the seatback angle (reclining)

Adjust the seatback to the angle providing a comfortable seated posture.

1. With your posture slightly slouched, move the seatback forward to the angle where your waist feels slightly cramped.



1. Manual Seat
2. Power Seat

Essential Safety Equipment

Seats

2. Move the seatback backward to a comfortable seated posture without any feeling of cramping in your waist.



1. Manual Seat
2. Power Seat

Adjusting the seat position forward and back (sliding)

Adjust the seat to the position best for operating the accelerator and brake pedals.

1. Place your left foot on the footrest, your right foot between the accelerator and brake pedals, and position your heel to the position allowing easy switching between the pedals.

2. With your heel set on the floor, set your right foot on the brake pedal and move the seat forward as far as possible until you feel a slight cramping in your ankle.



1. Manual Seat
2. Power Seat

3. With your right foot set on the brake pedal, move the seat back until you no longer feel cramping in your ankle.
4. With your heel set on the floor, make sure you can move your foot between the brake pedal and accelerator pedal smoothly.

5. Depress the accelerator pedal completely with your heel set on the floor and make sure that your ankle does not feel over-stretched.

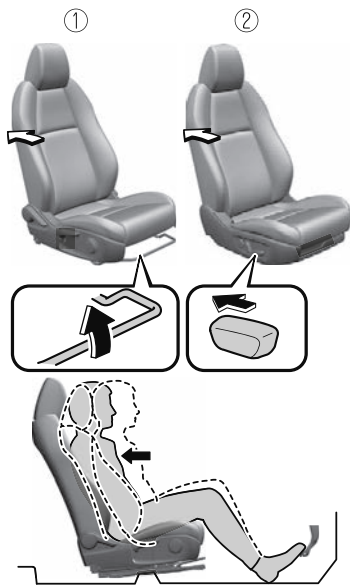

1. Manual Seat
2. Power Seat

Adjusting the seat height

Adjust the seat height to a position where you have a clear forward view and you can drive the vehicle easily.

1. With your back resting against the seatback, raise the seat to the height where you can see the rear edge area of the bonnet surface from the windscreen.

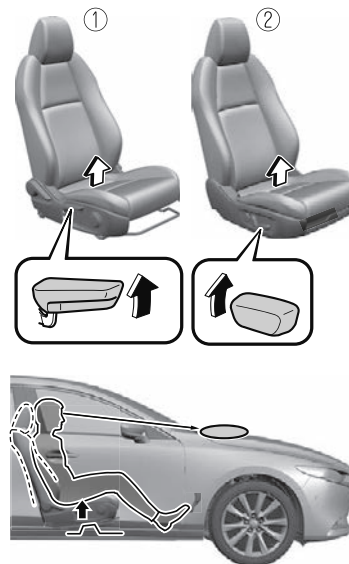

1. Manual Seat
2. Power Seat

Seats

Adjusting the height on the front edge of the seat bottom

Adjust the height on the front edge of the seat bottom to the position where the back of your knees contacts the front edge of the seat bottom.

1. With your right foot set on the accelerator pedal, adjust the height on the front edge of the seat bottom so that the back of your knees lightly contacts the front edge of the seat bottom.
2. Depress the accelerator pedal and make sure that you no longer feel cramping in the back of your knees.

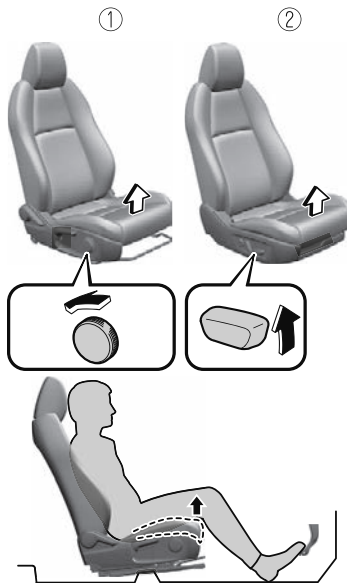

1. Manual Seat
2. Power Seat

Adjusting the steering wheel position

Adjust the steering wheel to the position where it can be operated easily and the gauges can be viewed easily.

1. With your back resting against the seatback, extend both arms, place them on the top of the steering wheel, and pull the steering wheel towards you to the position of your wrists.

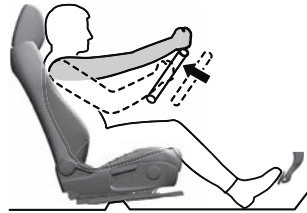

2. Adjust the steering wheel height so that the gauges can be viewed easily.
3. Raise the lever to securely lock the steering wheel.

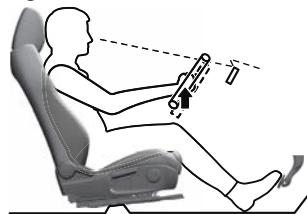

Adjusting the head restraint position

To prevent shock to the head and neck, adjust the head restraints to their correct positions.

Refer to Height Adjustment on page 2-18.

▼ Driving Position Memory (Power Seat)*

The desired driving position can be called up after programming the position. The following driving positions can be programmed.

- Driver's seat position (seat slide, height adjustment, front edge of seat bottom, seat recline)
Refer to Adjusting the Driver's Seat on page 2-5.
- Active driving display (display position, brightness level, display information)
Refer to Active Driving Display on page 4-35.
- Outside mirror angle
Refer to Outside Mirrors on page 3-27.

CAUTION

Do not place fingers or hands around the bottom of the seat while the seat memory function is operating. The seat moves automatically while the seat memory function is operating and fingers or hands could get pinched and injured.

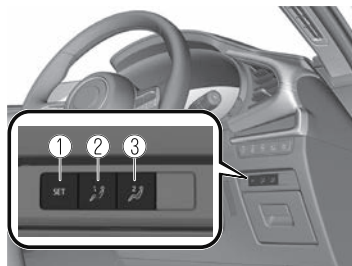

1. SET button
2. 1 button
3. 2 button

A driving position can be programmed to the following parts.

- Position memory button
- Transmitter used for vehicle

NOTE

- *Lumbar support adjustment cannot be programmed.*

Programming

1. Make sure the parking brake is on.
2. **(Automatic transmission)**
Make sure the selector lever is in the P position.
3. Switch the ignition ON.
4. Adjust the following parts to the desired conditions.
 - Driver's seat
 - Active driving display
 - Outside mirrors
5. Press the SET button continuously until a sound is activated.
6. Do the following operation within 5 seconds after the sound is activated to programme the driving position.

· **Programming to a position memory button**

Press the button you want to programme, either 1 or 2 button.

· **Programming to the transmitter**

Press the unlock button on the transmitter.

A sound is activated when the operation is completed correctly.

*Some models.

Seats

NOTE

- If you do not perform the operation correctly, a sound indicating that the programming has failed is activated.
- If the angle of the outer mirrors only changes a little, the angle of the outer mirrors may not have been programmed correctly.
- If the angle of the outer mirrors is adjusted close to the limits of its range of motion, the driving position can be successfully programmed, but it may fail when calling up the programmed driving position.

Calling up the programmed driving position

Using the position memory button

1. Make sure the parking brake is on.
2. **(Automatic transmission)**
Make sure the selector lever is in the P position.
3. Switch the ignition ON.
4. Press the programming button for the driving position you want to call up (button 1 or 2).
5. A sound is activated when the adjustment to the programmed driving position is completed.

NOTE

- When adjustment of the driving position is not necessary, a sound is not activated.
- The driving position adjustment is cancelled in the following cases:
 - The seat adjustment switch on the driver's seat is operated.
 - The angle of the outer mirrors is adjusted.

- The SET button is pressed.
- Programming button 1 or 2 is pressed.
- The lock button or unlock button on the transmitter is pressed.
- The vehicle starts moving.
- The active driving display is adjusted.
- **(Manual transmission)**
The parking brake is released.
- **(Automatic transmission)**
The selector lever is shifted to a position other than P.

Using the transmitter

1. Unlock the driver's door using one of the following methods.
 - Touch the sensing area of the door release touch sensor.
 - Press the unlock button on the transmitter.
2. When you open the driver's door within 90 seconds after unlocking the doors, the adjustment of the following parts starts.
 - Driver's seat
 - Active driving display (When the ignition is switched ON, the adjusted active driving display is activated.)
 - Outside mirrors

A sound is activated when the adjustment is completed.

NOTE

- When adjustment of the driving position is not necessary, a sound is not activated.
- The driving position adjustment is cancelled in the following cases:
 - The seat adjustment switch on the driver's seat is operated.

- The angle of the outer mirrors is adjusted.
- The SET button is pressed.
- Programming button 1 or 2 is pressed.
- The lock button or unlock button on the transmitter is pressed.
- The vehicle starts moving.
- The active driving display is adjusted.
- **(Manual transmission)**
The parking brake is released.
- **(Automatic transmission)**
The selector lever is shifted to a position other than P.

Erasing programmed driving positions

Erasing the driving positions programmed to the key

1. Switch the ignition OFF.
2. Press the SET button continuously until a sound is activated.
3. Press the lock button on the transmitter within 5 seconds after the sound is activated.

NOTE

If you do not perform the operation correctly, a sound indicating that the programming has failed is activated.

▼ Adjusting the Front Passenger's Seat

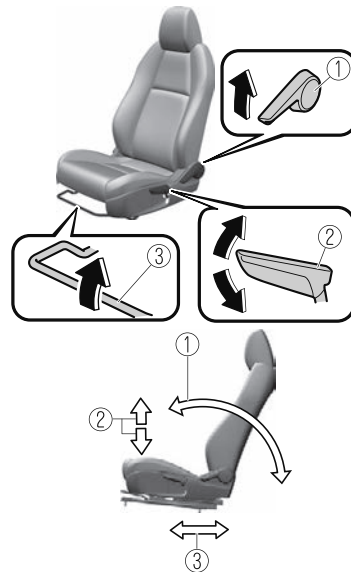

1. Seat Recline

To change the seatback angle, lean forward slightly while raising the lever. Then lean back to the desired position and release the lever.

Make sure the lever returns to its original position and the seatback is locked in place by attempting to push it forward and backward.

2. Height Adjustment*

To adjust the seat height, move the lever up or down.

Seats

3. Seat Slide

To move a seat forward or backward, raise the lever and slide the seat to the desired position and release the lever. Make sure the lever returns to its original position and the seat is locked in place by attempting to push it forward and backward.

Rear Seat

▼ Split Folding

By lowering the rear seatbacks the luggage compartment space can be expanded.

WARNING

Do not drive the vehicle with occupants on folded down seatbacks or in the luggage compartment.

Putting occupants in the luggage compartment is dangerous because seat belts cannot be fastened which could lead to serious injury or death during sudden braking or a collision.

Do not allow children to play inside the vehicle with the seatbacks lowered.

Allowing children to play in the vehicle with the seatbacks folded down is dangerous. If a child enters the luggage compartment and the seatbacks were raised back up, the child may become trapped in the luggage compartment which could lead to an accident.

Tightly secure cargo in the luggage compartment when it is transported with the seatbacks folded down.

Driving without tightly securing cargo and luggage is dangerous as it could move and become an obstruction to driving during emergency braking or a collision resulting in an unexpected accident.

When transporting cargo, do not allow the cargo to exceed the height of the seatbacks.

Transporting cargo stacked higher than the seatbacks is dangerous as visibility to the rear and sides of the vehicle is reduced which could interfere with driving operations and lead to an accident.

Lowering the seatbacks



➤ **(Hatchback)**

When folding the seatback forward, always support the seatback with your hand. If it is not supported by a hand, fingers or the hand pressing the push knob could be injured.

➤ **Check the position of a front seat before folding a rear seatback.**

Depending on the position of a front seat, it may not be possible to fold a rear seatback all the way down because it may hit the seatback of the front seat which could scratch or damage the front seat or its pocket. Lower or remove the head restraint on the rear outboard seat if necessary.

(Saloon)

1. Open the boot lid and pull the lever of the seatback you want to fold down.

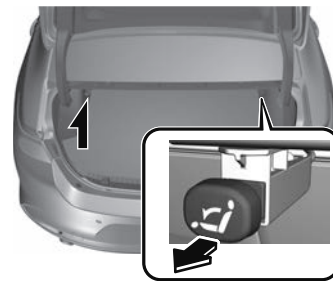

2. Open a rear door and fold the rear seat forward.

(Hatchback)

Press the push knob to fold down the seatback.

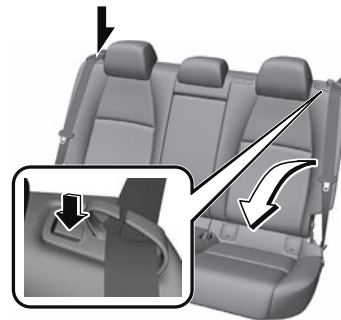

Seats

To return the seatback to its upright position:

⚠ WARNING

When returning a seatback to its upright position, make sure the 3-point seat belt is not caught in the seatback and the 3-point seat belt is not twisted.

If the seat belt is used while it is twisted and caught in the seatback, the seat belt cannot function at its full capacity, which could cause serious injury or death.

When returning a seatback to its upright position, make sure that it is firmly locked and the red indication is not visible (Hatchback).

If the red indication is visible behind the push knob, it means the seatback is not locked. If the vehicle is driven without the seatback locked, it could fold down suddenly and cause an accident.

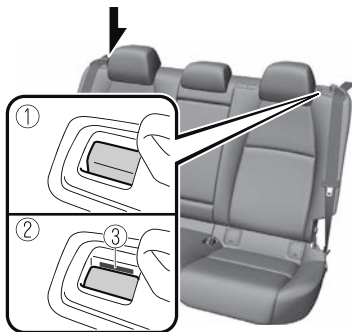

1. Locked position
2. Unlocked position
3. Red indication

1. Make sure that the seat belt passes through the seat belt guide correctly and it is not twisted, then raise the seatback while preventing the seat belt from being caught in the seatback.

(Saloon)

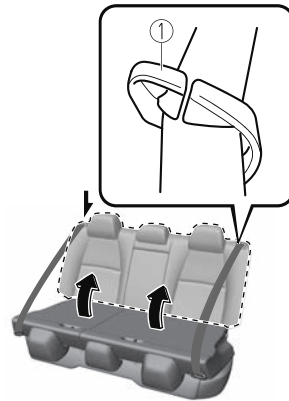

1. Seat belt guides

(Hatchback)

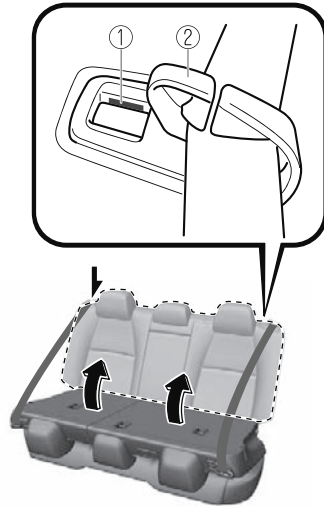

1. Red indication
 2. Seat belt guide
2. Press the seatback rearward and lock it in place. After returning the seatback to its upright position, make sure it is securely locked.

▼ Armrest*

The rear armrest in the centre of the rear seatback can be used (no occupant in the centre seat) or placed upright.

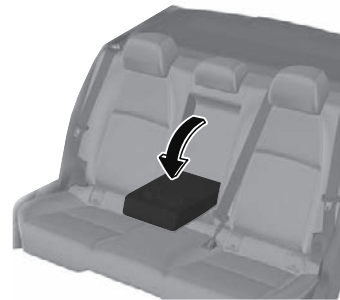

⚠ WARNING

Never put your hands and fingers around the moving parts of the seat and armrest:
Putting your hands and fingers around the moving parts of the seat and armrest is dangerous as they could get injured.

*Some models. **2-17**

Seats

Head Restraints

▼ Head Restraints

Your vehicle is equipped with head restraints on all outboard seats and the rear centre seat. The head restraints are intended to help protect you and the passengers from neck injury.

⚠ WARNING

Always drive with the head restraints installed when seats are being used and make sure they are properly adjusted: Driving with the head restraints adjusted too low or removed is dangerous. With no support behind your head, your neck could be seriously injured in a collision.

▼ Height Adjustment

Adjust the head restraint so that the centre is even with the top of the passenger's ears.

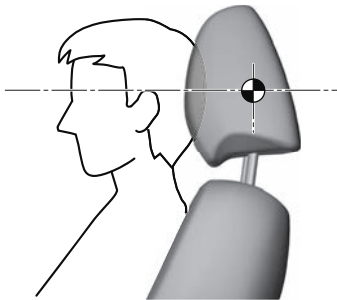

To raise a head restraint, pull it up to the desired position.

To lower the head restraint, press the stop-catch release, then push the head restraint down.

Front seats

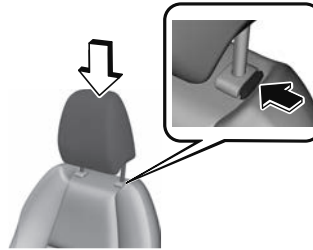

Rear outboard seats

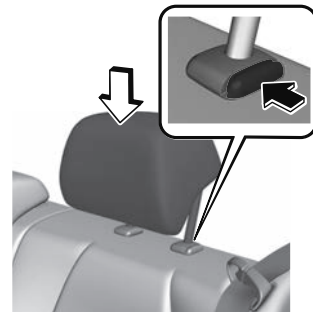

Rear centre seat

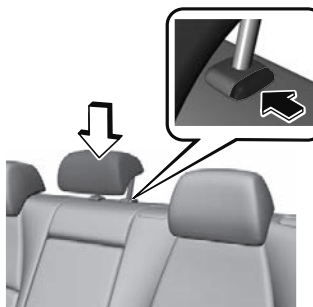

▼ **Removal/Installation**

To remove the head restraint, pull it up while pressing the stop-catch.

To install the head restraint, insert the legs into the holes while pressing the stop-catch.

! WARNING

Always drive with the head restraints installed when seats are being used and make sure they are properly installed:

Driving with the head restraints not installed is dangerous. With no support behind your head, your neck could be seriously injured in a collision.

After installing a head restraint, try lifting it to make sure that it does not pull out:

Driving with an unsecured head restraint is dangerous as the effectiveness of the head restraint will be compromised which could cause it to unexpectedly detach from the seat.

! CAUTION

➤ *When installing a head restraint, make sure that it is installed correctly with the front of the head restraint facing forward. If the head restraint is installed incorrectly, it could detach from the seat during a collision and result in injury.*

➤ *The head restraints on each of the front and rear seats are specialized to each seat. Do not switch around the head restraint positions. If a head restraint is not installed to its correct seat position, the effectiveness of the head restraint during a collision will be compromised which could cause injury.*

Seat Warmer/Heated Steering Wheel

Seat Warmer*

▼ Seat Warmer

The front seats can be warmed up while the engine is running.

While the seat warmer is operating, the indicator light in the seat warmer switch turns on according to the set temperature.

Manual mode

When the seat warmer switch is pressed, the seat warmer operates in manual mode. The set temperature changes as shown in the figure each time the seat warmer switch is pressed.

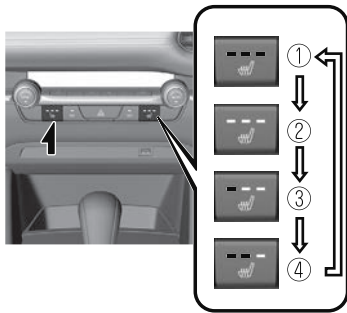

1. OFF
2. High
3. Mid
4. Low

NOTE

If the engine is turned off while the seat warmer is operating in manual mode, the seat warmer does not turn on automatically the next time the engine is turned on. To turn the seat warmer on, press the switch again.

Auto mode

The driver and front passenger's seat warmer can be operated in auto mode using the following procedure.

1. If "Link Seat & Climate Control Temperatures" has been disabled, enable it using the following procedure.
 - a) Select "Settings" from the MZD Connect home screen.
 - b) Select "Vehicle Settings".
 - c) Enable "Link Seat & Climate Control Temperatures".
2. Press the AUTO switch.

While in auto mode, the seat temperature is automatically controlled in 4 levels (High, Mid, Low, and OFF) according to the conditions in the cabin.

NOTE

- *If the front passenger's seat belt is unfastened, the front passenger's seat warmer turns off.*
- *If the seat warmer switch is pressed during auto mode, the seat warmer on the side where the switch was pressed switches to manual mode. To return to auto mode, press the AUTO switch.*
- *If the engine is turned off while the seat warmer is operating in auto mode, the seat warmer operates in auto mode again the next time the engine is turned on.*

Seat Warmer/Heated Steering Wheel

! WARNING

Be careful when using the seat warmer:

The heat from the seat warmer may be too hot for the following people and could cause a low-temperature burn.

- Infants, small children, elderly people, and physically challenged people
- People with delicate skin
- People who are excessively fatigued
- People who are intoxicated
- People who have taken sleep-inducing medicine such as sleeping pills or cold medicine

Do not use the seat warmer with anything having high moisture-retention ability such as a blanket or cushion on the seat:

The seat may be heated excessively and cause a low-temperature burn.

Do not use the seat warmer even when taking a short nap in the vehicle:

The seat may be heated excessively and cause a low-temperature burn.

Do not place heavy objects with sharp projections on the seat, or insert needles or pins into it:

This could cause the seat to become excessively heated and result in injury from a minor burn.

! CAUTION

- Do not use organic solvents to clean the seat. It may damage the seat surface and the heater.

Heated Steering Wheel*

▼ Heated Steering Wheel

The grips on the left and right of the steering wheel can be warmed up when the ignition is switched ON.

While the heated steering wheel is operating, the indicator light in the heated steering wheel switch turns on.

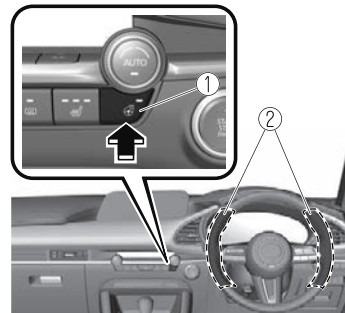

1. Heated steering wheel switch
2. Heating area

Manual mode

The heated steering wheel operates for about 30 minutes when the heated steering wheel switch is pressed, and then automatically turns off.

To turn the heated steering wheel off manually, press the switch again.

Auto mode

The heated steering wheel can be operated in auto mode using the following procedure.

1. If “Link Seat & Climate Control Temperatures” has been disabled, enable it using the following procedure.
 - a) Select “Settings” from the MZD Connect home screen.

*Some models.

2-21

Seat Warmer/Heated Steering Wheel

- b) Select “Vehicle Settings”.
 - c) Enable “Link Seat & Climate Control Temperatures”.
2. Press the AUTO switch.

While in auto mode, the heated steering wheel automatically operates/turns off according to the conditions in the cabin.

NOTE

- *If the heated steering wheel switch is pressed during auto mode, the heated steering wheel switches to manual mode. To return to auto mode, press the AUTO switch.*
- *If the ignition is switched OFF while the heated steering wheel is operating in auto mode, the heated steering wheel operates in auto mode again the next time the ignition is switched ON.*

CAUTION

The following types of persons should be careful not to touch the steering wheel. Otherwise, it could cause a low-temperature burn.

- *Infants, small children, elderly people, and physically challenged people*
- *People with delicate skin*
- *People who are excessively fatigued*
- *People who are intoxicated*
- *People who have taken sleep-inducing medicine such as sleeping pills or cold medicine*

Seat Belt Precautions

▼ Seat Belt Precautions

Seat belts help to decrease the possibility of severe injury during accidents and sudden stops. Mazda recommends that the driver and all passengers always wear seat belts.

All the seats have lap/shoulder belts. These belts also have retractors with inertia locks that keep them out of the way when not in use. The locks allow the belts to remain comfortable on users, but they will lock in position during a collision. The rear outboard seat belt retractors operate in two modes, emergency locking mode and, for child-restraint systems, automatic locking mode.

WARNING

Always wear your seat belt and make sure all occupants are properly restrained:

Not wearing a seat belt is extremely dangerous. During a collision, occupants not wearing seat belts could hit someone or things inside the vehicle or even be thrown out of the vehicle. They could be seriously injured or even killed. In the same collision, occupants wearing seat belts would be much safer.

Do not wear twisted seat belts:

Twisted seat belts are dangerous. In a collision, the full width of the belt is not available to absorb the impact. This puts more force on the bones beneath the belt, which could cause serious injury or death. So, if your seat belt is twisted, you must straighten the seat belt to remove any twists and to allow the full width of the belt to be used.

Never use one seat belt on more than one person at a time:

Using one seat belt for more than one person at a time is dangerous. A seat belt used in this way cannot spread the impact forces properly and the two passengers could be crushed together and seriously injured or even killed. Never use one belt for more than one person at a time and always operate the vehicle with each occupant properly restrained.

Do not operate a vehicle with a damaged seat belt:

Using a damaged seat belt is dangerous. An accident could damage the belt webbing of the seat belt in use. A damaged seat belt cannot provide adequate protection in a collision. Have an expert repairer, we recommend an Authorised Mazda Repairer inspect all seat belt systems in use during an accident before they are used again.

Seat Belt Systems

Have your seat belts changed immediately if the pretensioner or load limiter has been expended:

Always have an expert repairer, we recommend an Authorised Mazda Repairer immediately inspect the seat belt pretensioners and air bags after any collision. Like the air bags, the seat belt pretensioners and load limiters will only function once and must be replaced after any collision that caused them to deploy. If the seat belt pretensioners and load limiters are not replaced, the risk of injury in a collision will increase.

Positioning the Shoulder Portion of the Seat Belt:

Improper positioning of the shoulder portion of the seat belt is dangerous. Always make sure the shoulder portion of the seat belt is positioned across your shoulder and near your neck, but never under your arm, on your neck, or on your upper arm.

Positioning the Lap Portion of the Seat Belt:

The lap portion of the seat belt worn too high is dangerous. In a collision, this would concentrate the impact force directly on the abdominal area, causing serious injury. Wear the lap portion of the belt snugly and as low as possible.

Instructions for Use of Seat Belt Assemblies:

Seatbelts are designed to bear upon the bony structure of the body, and should be worn low across the front of the pelvis or the pelvis, chest and shoulders, as applicable; wearing the lap section of the belt across the abdominal area must be avoided.

Seatbelts should be adjusted as firmly as possible, consistent with comfort, to provide the protection for which they have been designed. A slack belt will greatly reduce the protection afforded to the wearer.

Care should be taken to avoid contamination of the webbing with polishes, oils and chemicals, and particularly battery acid. Cleaning may safely be carried out using mild soap and water. The belt should be replaced if webbing becomes frayed, contaminated or damaged.

It is essential to replace the entire assembly after it has been worn in a severe impact even if damage to the assembly is not obvious.

Belts should not be worn with straps twisted.

Each belt assembly must only be used by one occupant; it is dangerous to put a belt around a child being carried on the occupant's lap.

No modifications or additions should be made by the user which will either prevent the seat belt adjusting devices from operating to remove slack, or prevent the seat belt assembly from being adjusted to remove slack.

⚠ CAUTION

Belt retraction may become difficult if the belts and rings are soiled, so try to keep them clean. For more details about cleaning the seat belts, refer to "Seat Belt Maintenance" (page 6-49).

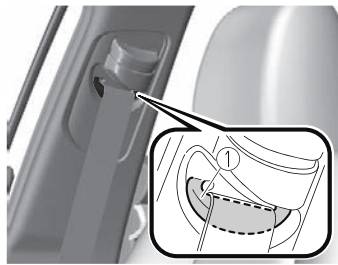

1. Ring

▼ Pregnant Women and Persons with Serious Medical Conditions

Pregnant women should always wear seat belts. Ask your doctor for specific recommendations.

The lap belt should be worn **SNUGLY AND AS LOW AS POSSIBLE OVER THE HIPS.**

The shoulder belt should be worn across your shoulder properly, but never across the stomach area.

Persons with serious medical conditions also should wear seat belts. Check with your doctor for any special instructions regarding specific medical conditions.

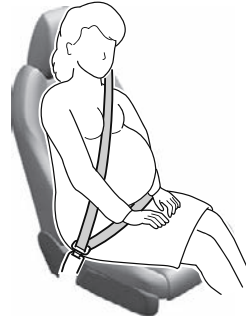

▼ Emergency Locking Mode

When the seat belt is fastened, it will always be in the emergency locking mode. In the emergency locking mode, the belt remains comfortable on the occupant and the retractor will lock in position during a collision.

If the belt is locked and cannot be pulled out, retract the belt once, and then try pulling it out slowly. If this fails, pull the belt strongly 1 time and loosen, then pull it out again slowly.

Seat Belt Systems

(Seat Belt with Automatic Locking Mode)

When the seat belt is fastened, it will always be in the emergency locking mode until it is switched to automatic locking mode by pulling it all the way out to its full length. If the belt feels tight and hinders comfortable movement while the vehicle is stopped or in motion, it may be in the automatic locking mode because the belt has been pulled too far out. To return the belt to the more comfortable emergency locking mode, wait until the vehicle has stopped in a safe, level area, retract the belt fully to convert it back to emergency locking mode and then extend it around you again.

▼ Automatic Locking Mode

Always use the automatic locking mode to keep the child-restraint system from shifting to an unsafe position in the event of an accident. To enable seat belt automatic locking mode, pull it all the way out and connect it as instructed on the child-restraint system. It will retract down to the child-restraint system and stay locked on it. See the section on child restraint (page 2-45).

Seat Belt

▼ Fastening the Seat Belt

Insert the seat belt tongue into the buckle.



1. Seat belt tongue
2. Seat belt buckle

Position the lap belt as low as possible, not on the abdominal area, then adjust the shoulder belt so that it fits snugly against your body.



1. Take up slack
2. Keep low on hip bone
3. Too high

Essential Safety Equipment
Seat Belt Systems

Before fastening the rear seat belt, make sure that the seat belt passes through the seat belt guide correctly and it is not twisted.



▼ **Unfastening the Seat Belt**

Depress the button on the seat belt buckle. If the belt does not fully retract, pull it out and check for kinks or twists. Then make sure it remains untwisted as it retracts.

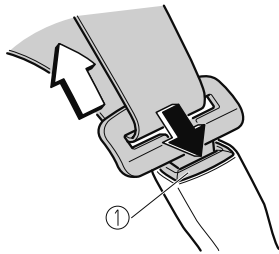

1. Button

NOTE

If a belt does not fully retract, inspect it for kinks and twists. If it is still not retracting properly, have it inspected at an expert repairer; we recommend an Authorised Mazda Repairer.

▼ **Front Shoulder Belt Adjuster**

The front seat belts have a front shoulder belt adjuster. If the seat belt contacts your neck or it slips off the shoulder, adjust the seat belt height.

To raise

To heighten the seat belt, move the front shoulder belt adjuster upward.



To lower

To lower the seat belt, lower it with the knob of the front shoulder belt adjuster pressed.



After adjusting, press the front shoulder belt adjuster downward and make sure that it is securely locked.

Seat Belt Systems

Seat Belt Warning Systems

▼ Seat Belt Warning Systems

If it detects that the occupant seat belt is unfastened, the warning light or beep alerts the occupant.

Refer to Seat Belt Warning Indication/Warning Light (Front seat) on page 7-31.

Refer to Seat Belt Warning Light (Rear seat) (Red) on page 7-32.

Refer to Seat Belt Warning Beep on page 7-37.

Seat belt indicator light (rear seat) (green)

REAR



The light turns on when the ignition is switched ON and a rear seat belt is fastened, and then it turns off after about 60 seconds.

Seat Belt Pretensioner and Load Limiting Systems

▼ Seat Belt Pretensioner and Load Limiting Systems

For optimum protection, the front seat belts and rear outboard seat belts are equipped with pretensioner and load limiting systems. For both these systems to work properly you must wear the seat belt properly.

Pretensioners:

When a collision is detected, the pretensioners deploy simultaneously with the air bags.

The pretensioners deploy simultaneously with the air bags when a roll-over is also detected.

For deployment details, refer to the SRS Air Bag Deployment Criteria (page 2-62).

The seat belt retractors remove slack quickly as the air bags are expanding. Any time the air bags and seat belt pretensioners have fired they must be replaced.

A system malfunction or operation conditions are indicated by a warning. Refer to Air Bag/Seat Belt Pretensioner System Warning Indication/Warning Light on page 7-28.

Refer to Air Bag/Seat Belt Pretensioner System Warning Beep on page 7-37.

In addition, the pretensioner system for the front passenger, like the front and side passenger air bag, is designed to only deploy when the front passenger air bag deactivation switch is turned to the ON position.

For details, refer to Front Passenger Air Bag Deactivation Switch (page 2-56).

Load limiter:

The load limiting system releases belt webbing in a controlled manner to reduce belt force on the occupant's chest. While the most severe load on a seat belt occurs in frontal collisions, the load limiter has an automatic mechanical function and can activate in any accident mode with sufficient occupant movement.

Even if the pretensioners have not fired, the load limiting function must be checked by an expert repairer, we recommend an Authorised Mazda Repairer.

 **WARNING**

Wear seat belts only as recommended in this owner's manual:

Incorrect positioning of the seat belts is dangerous. Without proper positioning, the pretensioner and load limiting systems cannot provide adequate protection in an accident and this could result in serious injury. For more details about wearing seat belts, refer to "Fastening the Seat Belt" (page 2-26).

Have your seat belts changed immediately if the pretensioner or load limiter has been expended:

Always have an expert repairer, we recommend an Authorised Mazda Repairer immediately inspect the seat belt pretensioners and air bags after any collision. Like the air bags, the seat belt pretensioners and load limiters will only function once and must be replaced after any collision that caused them to deploy. If the seat belt pretensioners and load limiters are not replaced, the risk of injury in a collision will increase.

Do not modify the components or wiring, or use electronic testing devices on the pretensioner system:

Modifying the components or wiring of the pretensioner system, including the use of electronic testing devices is dangerous. You could accidentally activate it or make it inoperable which would prevent it from activating in an accident. The occupants or repairers could be seriously injured.

Properly dispose of the pretensioner system:

Improper disposal of the pretensioner system or a vehicle with non-deactivated pretensioners is dangerous. Unless all safety procedures are followed, injury could result. Have an expert repairer, we recommend an Authorised Mazda Repairer safely dispose of the pretensioner system or scrap a pretensioner system equipped vehicle.

Seat Belt Systems

NOTE

- *The pretensioner system may not operate depending on the type of the collision. For details, refer to the SRS Air Bag Deployment Criteria (page 2-62).*
- *Some smoke (non-toxic gas) will be released when the air bags and pretensioners deploy. This does not indicate a fire. This gas normally has no effect on occupants, however, those with sensitive skin may experience light skin irritation. If residue from the deployment of the air bags or the pretensioner system gets on the skin or in the eyes, wash it off as soon as possible.*

Child-Restraint Precautions

▼ Child-Restraint Precautions

Mazda strongly urges the use of child-restraint systems for children small enough to use them.

Check your local and state or provincial laws for specific requirements regarding the safety of children riding in your vehicle.

Whatever child-restraint system you consider, please pick the appropriate one for the age and size of the child, obey the law and follow the instructions that come with the individual child-restraint system.

A child who has outgrown child-restraint systems should sit in the rear and use seat belts.

The child-restraint system should be installed on the rear seat. Statistics confirm that the rear seat is the best place for all children up to 12 years of age—the more so with a supplementary restraint system (air bags).

A rear-facing child-restraint system should **NEVER** be used in the front passenger seat with the air bag system activated. The front passenger's seat is also the least preferred seat for other child-restraint systems.

For some models, we have provided a deactivation switch that will disable front passenger air bag inflation. Do not switch off the front passenger air bag without reading the “Front Passenger Air Bag Deactivation Switch” (page 2-56).

WARNING

Use the correct size child-restraint system:

For effective protection in vehicle accidents and sudden stops, a child must be properly restrained using a seat belt or child-restraint system depending on age and size. If not, the child could be seriously injured or even killed in an accident.

Follow the manufacturer's instructions and always keep the child-restraint system buckled down:

An unsecured child-restraint system is dangerous. In a sudden stop or a collision it could move causing serious injury or death to the child or other occupants. Make sure any child-restraint system is properly secured in place according to the child-restraint system manufacturer's instructions. When not in use, remove it from the vehicle or fasten it with a seat belt, or latch it down to BOTH ISOFIX anchors, and attach the corresponding tether anchor.

Child Restraint

Always secure a child in a proper child-restraint system:

Holding a child in your arms while the vehicle is moving is extremely dangerous. No matter how strong the person may be, he or she cannot hold onto a child in a sudden stop or collision and it could result in serious injury or death to the child or other occupants. Even in a moderate accident, the child may be exposed to air bag forces that could result in serious injury or death to the child, or the child may be slammed into an adult, causing injury to both child and adult.

Extreme Hazard! Never use a rear-facing child-restraint system on the front passenger seat with an air bag that could deploy:

NEVER use a rearward facing child restraint on a seat protected by an ACTIVE AIRBAG in front of it, DEATH or SERIOUS INJURY to the CHILD can occur.

Vehicles with a front passenger air bag have the following warning label. The warning label reminds you not to put a rear-facing child-restraint system on the front passenger seat at any time.



Even in a moderate collision, the child-restraint system can be hit by a deploying air bag and moved violently backward resulting in serious injury or death to the child. When using a rear-facing child-restraint system, always set the front passenger air bag deactivation switch to the OFF position.



Do not install a front-facing child-restraint system on the front passenger seat unless it is unavoidable:

In a collision, the force of a deploying air bag could cause serious injury or death to the child. If installing a front-facing child-restraint system on the front passenger seat is unavoidable, move the front passenger seat as far back as possible and adjust the seat bottom (height adjustable seat bottom) to the highest position at which the seat belt fastening the child-restraint system is securely tightened.

Make sure that the front passenger air bag deactivation switch is in the OFF position. Refer to Front Passenger Air Bag Deactivation Switch (page 2-56).



Do not allow a child or anyone to lean over or against the side window of a vehicle with side and curtain air bags:

It is dangerous to allow anyone to lean over or against the side window, the area of the front passenger seat, the front and rear window pillars and the roof edge along both sides from which the side and curtain air bags deploy, even if a child-restraint system is used. The impact of inflation from a side or curtain air bag could cause serious injury or death to an out of position child. Furthermore, leaning over or against the front door could block the side and curtain air bags and eliminate the advantages of supplementary protection. With the front air bag and the additional side air bag that comes out of the front seat, the rear seat is always a better location for children. Take special care not to allow a child to lean over or against the side window, even if the child is seated in a child-restraint system.

Never use one seat belt on more than one person at a time:

Using one seat belt for more than one person at a time is dangerous. A seat belt used in this way cannot spread the impact forces properly and the two passengers could be crushed together and seriously injured or even killed. Never use one belt for more than one person at a time and always operate the vehicle with each occupant properly restrained.

WARNING: child restraint anchorages are designed to withstand only those loads imposed by correctly fitted child restraints. Under no circumstances are they to be used for adult seat belts, harnesses or for attaching other items or equipment to the vehicle.

Always remove the head restraint and install child-restraint system (except when installing a backless booster seat):

Installing a child-restraint system without removing the head restraint is dangerous. The child-restraint system cannot be installed correctly which may result in death or injury to the child in a collision.

CAUTION

A seat belt or child-restraint system can become very hot in a closed vehicle during warm weather. To avoid burning yourself or a child, check them before you or your child touches them.

Essential Safety Equipment

Child Restraint

NOTE

Your Mazda is equipped with ISOFIX anchors for attachment of ISOFIX child-restraint systems on the rear seats. When using these anchors to secure a child-restraint system, refer to “Using ISOFIX Anchor” (page 2-48).

Child-Restraint System Installation

▼ Categories of Child-Restraint Systems

NOTE

When purchasing, ask the manufacturer of the child-restraint system which type of child-restraint system is appropriate for your child and vehicle.

(Countries conforming to the UN-R 44 and UN-R 129 regulation)

Child-restraint systems are classified into the following 5 groups according to the UN-R 44 regulation.

Group	Age	Weight	Size Classification/ Fixture (CRF)
0	Up to about 9 months old	Up to 10 kg (up to 22 lb)	ISO/L1
			ISO/L2
			ISO/R1
0+	Up to about 2 years old	Up to 13 kg (up to 29 lb)	ISO/R1
			ISO/R2
			ISO/R3
1	About 8 months to 4 years old	9 kg — 18 kg (20 lb — 40 lb)	ISO/R2
			ISO/R3
			ISO/F2
			ISO/F2X
			ISO/F3
2	About 3 to 7 years old	15 kg — 25 kg (33 lb — 55 lb)	—
3	About 6 to 12 years old	22 kg — 36 kg (48 lb — 79 lb)	—

(Australia)

Child-restraint systems for Australia must conform to Australian Standard AS 1754/91 or later. Refer to your local state authority for the latest specification.

(Other countries)

Please comply with the legal regulations concerning the use of child-restraint systems in your country.

▼ Child-Restraint System Types

In this owner's manual, explanation of child-restraint systems secured with seat belts is provided for the following 3 types of popular child-restraint systems: baby seat, child seat, booster seat.

NOTE

*· Installation position is determined by the type of child-restraint system.
 Always read the manufacturer's instructions and this owner's manual carefully.*

Child Restraint

· Due to variations in the design of child-restraint systems, vehicle seats and seat belts, all child-restraint systems may not fit all seating positions. Before purchasing a child-restraint system, it should be tested in the specific vehicle seating position (or positions) where it is intended to be used. If a previously purchased child-restraint system does not fit, you may need to purchase a different one that will.

Baby seat

A baby seat provides restraint by bracing the baby's head, neck and back against the seating surface.

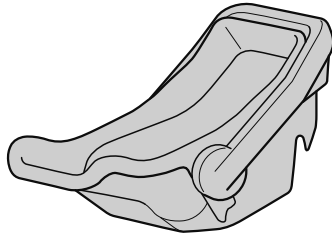

Child seat

A child seat restrains a child's body using the harness.



Booster seat

A booster seat is a child restraint accessory designed to improve the fit of the seat belt system around the child's body.

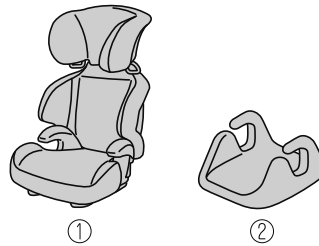

1. Full booster seat
2. Backless booster seat

When using a backless booster seat, always install the vehicle head restraint to the seat where the backless booster seat is installed.

(Australia)

Child-restraint systems for Australia must conform to Australian Standard AS 1754/91 or later.

(Other countries)

Please comply with the legal regulations concerning the use of child-restraint systems in your country.

▼ **Baby Seat Installation Position**

A baby seat is used in the rear-facing position only.

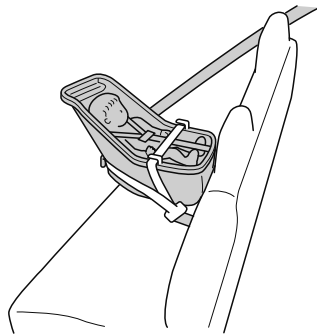

⚠ WARNING

Never use a rear-facing child-restraint system on the front passenger seat protected by an air bag:

NEVER use a rearward facing child restraint on a seat protected by an ACTIVE AIRBAG in front of it, DEATH or SERIOUS INJURY to the CHILD can occur.

The child-restraint system can be hit by the deploying air bag and knocked out of position. A child in the child-restraint system could be seriously injured or killed. If your vehicle is equipped with a front passenger air bag deactivation switch, always set the switch to the OFF position if installing a rear-facing child-restraint system on the front passenger seat is unavoidable.



▼ **Child Seat Installation Position**

A child seat is used in front-facing and rear-facing positions depending on the age and size of the child. When installing, follow the manufacturer's instructions in accordance with the appropriate age and size of the child as well as the directions for installing the child-restraint system.

Rear-facing type

⚠ WARNING

Never use a rear-facing child-restraint system on the front passenger seat protected by an air bag:

NEVER use a rearward facing child restraint on a seat protected by an ACTIVE AIRBAG in front of it, DEATH or SERIOUS INJURY to the CHILD can occur.

Child Restraint

The child-restraint system can be hit by the deploying air bag and knocked out of position. A child in the child-restraint system could be seriously injured or killed. If your vehicle is equipped with a front passenger air bag deactivation switch, always set the switch to the OFF position if installing a rear-facing child-restraint system on the front passenger seat is unavoidable.



Front-facing type



Do not install a front-facing child-restraint system on the front passenger seat unless it is unavoidable:

In a collision, the force of a deploying air bag could cause serious injury or death to the child. If installing a front-facing child-restraint system on the front passenger seat is unavoidable, move the front passenger seat as far back as possible and adjust the seat bottom (height adjustable seat bottom) to the highest position at which the seat belt fastening the child-restraint system is securely tightened.

Make sure that the front passenger air bag deactivation switch is in the OFF position. Refer to Front Passenger Air Bag Deactivation Switch (page 2-56).



▼ Booster Seat Installation Position

A booster seat is used in the front-facing position only.

We recommend the use of the booster seat with backrest to allow simple adjustment of the shoulder belt position and to give your child the best protection.



⚠ WARNING

Do not install a front-facing child-restraint system on the front passenger seat unless it is unavoidable:

In a collision, the force of a deploying air bag could cause serious injury or death to the child. If installing a front-facing child-restraint system on the front passenger seat is unavoidable, move the front passenger seat as far back as possible and adjust the seat bottom (height adjustable seat bottom) to the highest position at which the seat belt fastening the child-restraint system is securely tightened.

Make sure that the front passenger air bag deactivation switch is in the OFF position. Refer to Front Passenger Air Bag Deactivation Switch (page 2-56).



Child-Restraint System Suitability for Various Seat Positions Table

▼ Child-Restraint System Suitability for Various Seat Positions Table

Provided information in the table shows your child-restraint system suitability for various seating position. For installation suitability of other manufacturer child-restraint system, carefully consult the manufacturer's instructions which accompany the child-restraint system.

When installing a child-restraint system, the following points must be observed:

- Always remove the head restraint before installing a child-restraint system. However, when installing a backless booster seat, always install the vehicle head restraint to the seat where the backless booster seat is installed. In addition, always use a tether strap and attach it securely. Refer to Head Restraints on page 2-18.
- When installing a child-restraint system to the front passenger seat, adjust the seat slide position as far back as possible. Adjust the seat bottom to the highest position so that the seat belt can securely fasten the child-restraint system.
Refer to Adjusting the Front Passenger's Seat on page 2-13.
- When it is difficult to install a child-restraint system to the front passenger seat, or the seat belt cannot be secured to the child-restraint system, perform the following operations to adjust the seat holding the child-restraint system so that the seat belt can be secured completely to it.
 - Move the seat forward or back.
 - Move the seatback forward or back.
- When installing a child-restraint system to the rear seat, adjust the front seat position so that the front seat does not contact the child-restraint system.
Refer to Adjusting the Driver's Seat on page 2-5.
Refer to Adjusting the Front Passenger's Seat on page 2-13.
- When installing a child-restraint system came equipped with a tether, remove the head restraint.
Refer to Head Restraints on page 2-18.
- An i-Size child-restraint system refers to a child-restraint system which has acquired i-Size category certification for the UN-R 129 regulation.

When installing a child-restraint system to the rear seat, refer to the child-restraint system manufacturer's instructions and the Using ISOFIX Anchor on page 2-48.

Essential Safety Equipment
Child Restraint

Seating position	Passenger		Rear (Left)	Rear (Centre)	Rear (Right)
	Airbag activated	Airbag de-activated			
Seating position suitable for universal belted (Yes/No)	Yes (UF)	Yes (U)	Yes (U)	Yes (U)	Yes (U)
i-Size seating position (Yes/No)	No	No	Yes (i-U)	No	Yes (i-U)
Largest suitable rearward facing fixture (R1)	No	No	Yes (IL)	No	Yes (IL)
Largest suitable rearward facing fixture (R2)	No	No	Yes (IL)	No	Yes (IL)
Largest suitable rearward facing fixture (R2X)	No	No	Yes (IL)	No	Yes (IL)
Largest suitable rearward facing fixture (R3)	No	No	Yes (IL)	No	Yes (IL)
Largest suitable forward facing fixture (F2)	No	No	Yes (IUF)	No	Yes (IUF)
Largest suitable forward facing fixture (F2X)	No	No	Yes (IUF)	No	Yes (IUF)
Largest suitable forward facing fixture (F3)	No	No	Yes (IUF)	No	Yes (IUF)
Largest suitable lateral facing fixture (L1)	No	No	No	No	No
Largest suitable lateral facing fixture (L2)	No	No	No	No	No
Largest suitable booster fixture (B2)	No	No	Yes (IUF)	No	Yes (IUF)
Largest suitable booster fixture (B3)	No	No	Yes (IUF)	No	Yes (IUF)

Essential Safety Equipment

Child Restraint

Seating position	Passenger		Rear (Left)	Rear (Centre)	Rear (Right)
	Airbag activated	Airbag de-activated			
Non i-size compatible with a support leg (Yes/No)	Yes*1	Yes	Yes	No	Yes
Lower ISOFIX anchorages but without Top Tether (Yes/No)	No	No	No	No	No

U = Suitable for “universal” category restraints approved for use in this mass group.

UF = Suitable for forward-facing “universal” category restraints approved for use in this mass group.

IUF = Suitable for ISOFIX forward child restraints systems of universal category approved for use in the mass group.

L = Suitable for particular child restraints given on attached list. These restraints may be of the “specific vehicle”, “restricted” or “semi-universal” categories.

IL = Suitable for particular ISOFIX child restraint systems (CRS) given in the attached list. These ISOFIX CRS are those of the “specific vehicle”, “restricted” or “semi-universal” categories.

i-U = Suitable for i-Size “universal” Child Restraint Systems forward and rearward facing.

i-UF = Suitable for forward-facing i-Size “universal” Child Restraint Systems only.

Yes = Child-restraint system can be secured on the seat.

No = Child-restraint system cannot be secured on the seat, or there is no fixture.

X = Child-restraint system cannot be installed.

*1 Child restraint system can only be installed in the forward-facing position.

A Mazda genuine child-restraint system can be installed. Regarding child-restraint systems which can be installed, refer to the accessories catalog.

Installing Child-Restraint Systems

▼ Anchor Bracket

Anchor brackets for securing child-restraint systems are equipped in the vehicle. Locate each anchor position using the illustration.

To install a child-restraint system, remove the head restraint. Always follow the instruction manual accompanying the child-restraint system.

Anchor bracket location

Use the indicated anchor bracket locations when installing a child-restraint system equipped with a tether.

(Saloon)

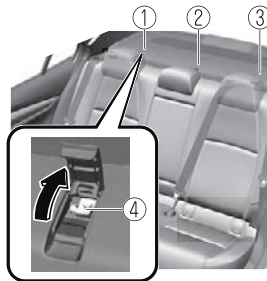

1. For right
2. For centre
3. For left
4. Anchor bracket

(Hatchback)

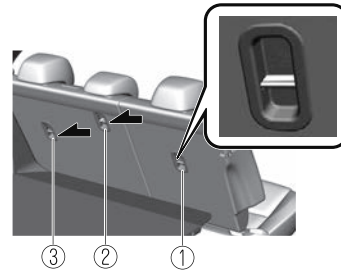

1. For right
2. For centre
3. For left

⚠ WARNING

WARNING: child restraint anchorages are designed to withstand only those loads imposed by correctly fitted child restraints. Under no circumstances are they to be used for adult seat belts, harnesses or for attaching other items or equipment to the vehicle.

Always attach the tether strap to the correct tether anchor position:

Attaching the tether strap to the incorrect tether anchor position is dangerous. In a collision, the tether strap could come off and loosen the child-restraint system. If the child-restraint system moves it could result in death or injury to the child.

Always remove the head restraint and install child-restraint system:

Installing a child-restraint system without removing the head restraint is dangerous. The child-restraint system cannot be installed correctly which may result in death or injury to the child in a collision.

Essential Safety Equipment
Child Restraint

(Saloon)

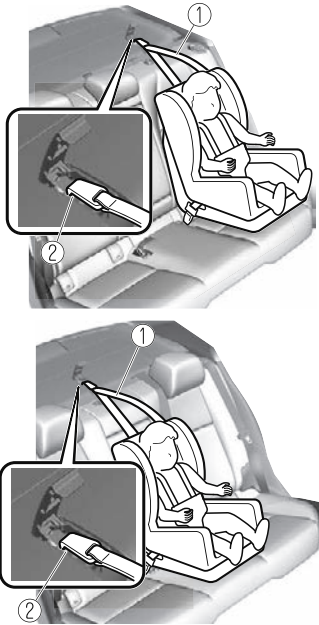

1. Tether strap
2. Anchor bracket

(Hatchback)

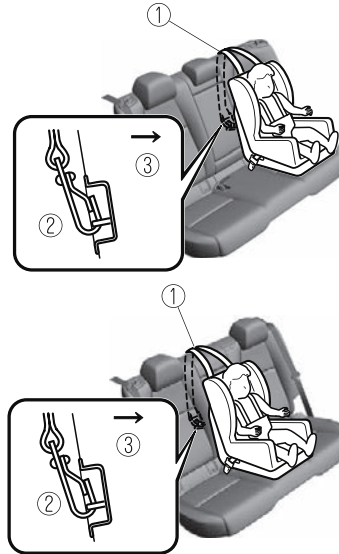

1. Tether strap
2. Anchor bracket
3. Forward

Always install the head restraint and adjust it to the appropriate position after removing the child-restraint system:

Driving with the head restraint removed is dangerous as impact to the occupant's head cannot be prevented during emergency braking or in a collision, which could result in a serious accident, injury or death.

Refer to Head Restraints on page 2-18.

▼ **Using Automatic Locking Mode**

Follow these instructions when using the automatic locking mode for a child-restraint system.

1. Make sure the seatback is securely latched by pushing it back until it is fully locked.
2. Remove the head restraint. However, when installing a backless booster seat, always install the vehicle head restraint to the seat where the backless booster seat is installed.
Refer to Head Restraints on page 2-18.
3. Secure the child-restraint system with the lap portion of the lap/shoulder belt. See the manufacturer's instructions on the child-restraint system for belt routing instructions.
4. To get the retractor into the automatic locking mode, pull the shoulder belt portion of the seat belt until the entire length of the belt is out of the retractor.



5. Push the child-restraint system firmly into the vehicle seat. Be sure the belt retracts as snugly as possible. A clicking noise from the retractor will be heard during retraction if the system is in the automatic locking mode. If the belt does not lock the seat down tight, repeat this step.



NOTE

- *Inspect this function before each use of the child-restraint system. You should not be able to pull the shoulder belt out of the retractor while the system is in the automatic locking mode. When you remove the child-restraint system, be sure the belt fully retracts to return the system to emergency locking mode before occupants use the seat belts.*
6. If your child-restraint system requires the use of a tether strap, refer to the manufacturer's instructions to hook and tighten the tether strap.

Essential Safety Equipment
Child Restraint

! WARNING

WARNING: child restraint anchorages are designed to withstand only those loads imposed by correctly fitted child restraints. Under no circumstances are they to be used for adult seat belts, harnesses or for attaching other items or equipment to the vehicle.

Always remove the head restraint and install child-restraint system (except when installing a backless booster seat):

Installing a child-restraint system without removing the head restraint is dangerous. The child-restraint system cannot be installed correctly which may result in death or injury to the child in a collision.

(Saloon)

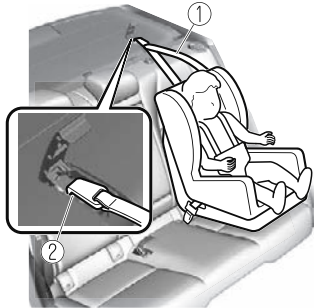

1. Tether strap
2. Anchor bracket

(Hatchback)

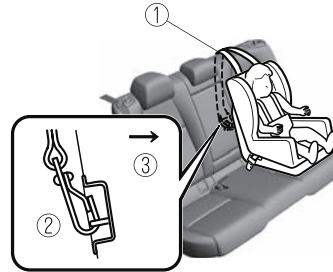

1. Tether strap
2. Anchor bracket
3. Forward

Always attach the tether strap to the correct tether anchor position:

Attaching the tether strap to the incorrect tether anchor position is dangerous. In a collision, the tether strap could come off and loosen the child-restraint system. If the child-restraint system moves it could result in death or injury to the child.

Always install the head restraint and adjust it to the appropriate position after removing the child-restraint system:

Driving with the head restraint removed is dangerous as impact to the occupant's head cannot be prevented during emergency braking or in a collision, which could result in a serious accident, injury or death.

Refer to Head Restraints on page 2-18.

▼ **Centre-Rear Seat Child-Restraint System Installation**

1. Make sure the seatback is securely latched by pushing it back until it is fully locked.
2. Remove the head restraint. However, when installing a backless booster seat, always install the vehicle head restraint to the seat where the backless booster seat is installed.
Refer to Head Restraints on page 2-18.
3. Secure the child-restraint system with the seat belt, according to the manufacturer's instructions.
4. Secure the tether strap according to the child-restraint system manufacturer's instruction.

⚠ WARNING

WARNING: child restraint anchorages are designed to withstand only those loads imposed by correctly fitted child restraints. Under no circumstances are they to be used for adult seat belts, harnesses or for attaching other items or equipment to the vehicle.

Always remove the head restraint and install child-restraint system (except when installing a backless booster seat):

Installing a child-restraint system without removing the head restraint is dangerous. The child-restraint system cannot be installed correctly which may result in death or injury to the child in a collision.

(Saloon)

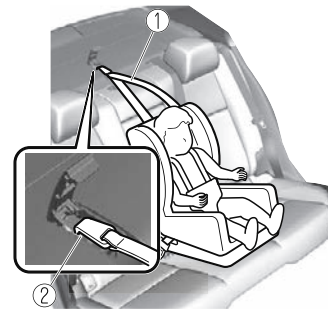

1. Tether strap
2. Anchor bracket

(Hatchback)

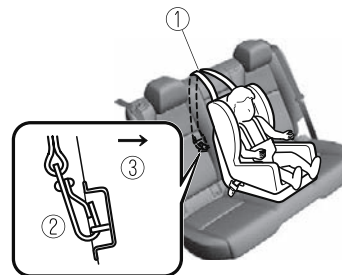

1. Tether strap
2. Anchor bracket
3. Forward

Child Restraint

Always attach the tether strap to the correct tether anchor position:

Attaching the tether strap to the incorrect tether anchor position is dangerous. In a collision, the tether strap could come off and loosen the child-restraint system. If the child-restraint system moves it could result in death or injury to the child.

Always install the head restraint and adjust it to the appropriate position after removing the child-restraint system:

Driving with the head restraint removed is dangerous as impact to the occupant's head cannot be prevented during emergency braking or in a collision, which could result in a serious accident, injury or death.

Refer to Head Restraints on page 2-18.

▼ **Using ISOFIX Anchor**



Follow the manufacturer's instructions for the use of the child-restraint system:

An unsecured child-restraint system is dangerous. In a sudden stop or a collision it could move causing serious injury or death to the child or other occupants. Make sure any child-restraint system is properly secured in place according to the manufacturer's instructions.

Make sure the child-restraint system is properly secured:

A child-restraint system that is not secured is dangerous. In a sudden stop or collision, it can become a projectile and hit someone, causing serious injury. When not in use, remove it from the vehicle, put it in the luggage compartment or at least make sure it is securely fastened to the ISOFIX anchors.

Make sure there are no seat belts or foreign objects near or around the ISOFIX anchor-secured child-restraint system:

Not following the child-restraint system manufacturer's instructions when installing the child-restraint system is dangerous. If seat belts or a foreign object prevent the child-restraint system from being securely attached to the ISOFIX anchors and the child-restraint system is installed improperly, the child-restraint system could move in a sudden stop or collision causing serious injury or death to the child or other occupants. When installing the child-restraint system, make sure there are no seat belts or foreign objects near or around the ISOFIX anchors. Always follow the child-restraint system manufacturer's instructions.

1. First, adjust the front seat to allow clearance between the child-restraint system and the front seat.
Refer to Adjusting the Driver's Seat on page 2-5.
Refer to Adjusting the Front Passenger's Seat on page 2-13.
2. Make sure the seatback is securely latched by pushing it back until it is fully locked.

3. Remove the cover of the child-restraint system's ISOFIX anchors to verify the locations of the ISOFIX anchors.

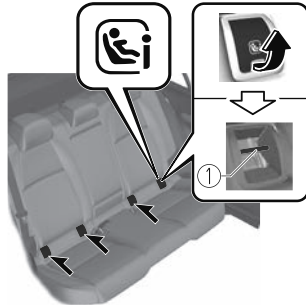

1. ISOFIX anchor

NOTE

- The ISOFIX anchors marking on the cover indicates the position of the ISOFIX anchors for the attachment of a child-restraint system.
 - Store the removed cover so that it does not get lost.
4. Remove the head restraint. However, when installing a backless booster seat, always install the vehicle head restraint to the seat where the backless booster seat is installed.
Refer to Head Restraints on page 2-18.
 5. Secure the child-restraint system using the ISOFIX anchor, following the child-restraint system manufacturer's instruction.
 6. If your child-restraint system came equipped with a tether, that probably means it is very important to properly secure the tether for child safety. Please carefully follow the child-restraint system manufacturer's instructions when installing tethers (page 2-43).

! WARNING

WARNING: child restraint anchorages are designed to withstand only those loads imposed by correctly fitted child restraints. Under no circumstances are they to be used for adult seat belts, harnesses or for attaching other items or equipment to the vehicle.

! WARNING

Always attach the tether strap to the correct tether anchor position:

Attaching the tether strap to the incorrect tether anchor position is dangerous. In a collision, the tether strap could come off and loosen the child-restraint system. If the child-restraint system moves it could result in death or injury to the child.

Child Restraint

Always remove the head restraint and set the tether strap (except when installing a backless booster seat):

Routing the tether strap on top of the head restraint is dangerous. In a collision the tether strap could slide off the head restraint and loosen the child-restraint system. The child-restraint system could move which may result in death or injury to the child.

Always install the head restraint and adjust it to the appropriate position after removing the child-restraint system:

Driving with the head restraint removed is dangerous as impact to the occupant's head cannot be prevented during emergency braking or in a collision, which could result in a serious accident, injury or death.

Refer to Head Restraints on page 2-18.

(Saloon)

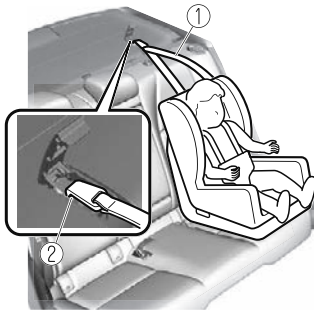

1. Tether strap
2. Anchor bracket

(Hatchback)

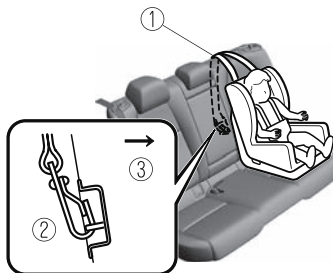

1. Tether strap
2. Anchor bracket
3. Forward

Supplementary Restraint System (SRS) Precautions

▼ Supplementary Restraint System (SRS) Precautions

The front and side supplementary restraint systems (SRS) include different types of air bags. **Please verify the different types of air bags which are equipped on your vehicle by locating the “SRS AIRBAG” location indicators.** These indicators are visible in the area where the air bags are installed.

The air bags are installed in the following locations:

- The steering wheel hub (driver air bag)
- The front passenger instrument panel (front passenger air bag)
- Under the instrument panel (driver knee air bag)
- The outboard sides of the front seatbacks (side air bags)
- The front and rear window pillars, and the roof edge along both sides (curtain air bags)

The air bag supplementary restraint systems are designed to provide supplementary protection in certain situations so seat belts are always important in the following ways:

Without seat belt usage, the air bags cannot provide adequate protection during an accident. Seat belt usage is necessary to:

- Keep the occupant from being thrown into an inflating air bag.

- Reduce the possibility of injuries during an accident that is not designed for air bag inflation, such as rear impact.
- Reduce the possibility of injuries in frontal, near frontal or side collisions or roll-over accidents that are not severe enough to activate the air bags.
- Reduce the possibility of being thrown from your vehicle.
- Reduce the possibility of injuries to lower body and legs during an accident because the air bags provide no protection to these parts of the body.
- Hold the driver in a position which allows better control of the vehicle.

A child who is too small to use a seat belt must be properly secured using a child-restraint system (page 2-31).

Carefully consider which child-restraint system is necessary for your child and follow the installation directions in this Owner's Manual as well as the child-restraint system manufacturer's instructions.

SRS Air Bags

WARNING

Seat belts must be worn in air bag equipped vehicles:

Depending only on the air bags for protection during an accident is dangerous. Alone, air bags may not prevent serious injuries. The appropriate air bags can be expected to inflate only in the first accident, such as frontal, near frontal or side collisions or roll-over accidents that are at least moderate. Vehicle occupants should always wear seat belts.

Children should not ride in the front passenger seat:

Placing a child, 12 years or under, in the front seat is dangerous. The child could be hit by a deploying air bag and be seriously injured or even killed. A sleeping child is more likely to lean against the door and be hit by the side air bag in moderate collision to the front-passenger side of the vehicle. Whenever possible, always secure a child 12 years and under on the rear seats with an appropriate child-restraint system for the child's age and size.

Extreme Hazard! Never use a rear-facing child-restraint system on the front passenger seat with an air bag that could deploy:

NEVER use a rearward facing child restraint on a seat protected by an ACTIVE AIRBAG in front of it, DEATH or SERIOUS INJURY to the CHILD can occur.

Even in a moderate collision, the child-restraint system can be hit by a deploying air bag and moved violently backward resulting in serious injury or death to the child. If your vehicle is equipped with a front passenger air bag deactivation switch, always set the switch to the OFF position when installing a rear-facing child-restraint system on the front passenger seat.



Do not sit too close to the driver and front passenger air bags:

Sitting too close to the driver and front passenger air bag modules or placing hands or feet on them is extremely dangerous. The driver and front passenger air bags inflate with great force and speed. Serious injuries could occur if someone is too close. The driver should always hold onto only the rim of the steering wheel. The front seat passenger should keep both feet on the floor. Front seat occupants should adjust their seats as far back as possible and always sit upright against the seatbacks with seat belts worn properly.

Sit in the centre of the seat and wear seat belts properly:

Sitting too close to the side air bag modules or placing hands on them, or sleeping up against the door or hanging out the windows is extremely dangerous. The side and curtain air bags inflate with great force and speed directly expanding along the door on the side the car is hit. Serious injury could occur if someone is sitting too close to the door or leaning against a window, or if rear seat occupants grab the sides of the front seatbacks. Give the side and curtain air bags room to work by sitting in the centre of the seat while the vehicle is moving with seat belts worn properly.

Do not attach objects on or around the area where driver and front passenger air bags deploy:

Attaching an object to the driver and front passenger air bag modules or placing something in front of them is dangerous. In an accident, an object could interfere with air bag inflation and injure the occupants.

Do not attach objects on or around the area where a side air bag deploys:

Attaching objects to the front seat in such a way as to cover the outboard side of the seat in any way is dangerous. In an accident the object could interfere with the side air bag, which inflates from the outboard side of the front seats, impeding the added protection of the side air bag system or redirecting the air bag in a way that is dangerous. Furthermore, the bag could be cut open releasing the gas.

Do not hang net bags, map pouches or backpacks with side straps on the front seats. Never use seat covers on the front seats. Always keep the side air bag modules in your front seats free to deploy in the event of a side collision.

Do not attach objects on or around the area where a curtain air bag deploys:

Attaching objects to the areas where the curtain air bag activates such as on the windscreen glass, side door glass, front and rear window pillars and along the roof edge and assist grips is dangerous. In an accident the object could interfere with the curtain air bag, which inflates from the front and rear window pillars and along the roof edge, impeding the added protection of the curtain air bag system or redirecting the air bag in a way that is dangerous. Furthermore, the bag could be cut open releasing the gas.

Do not place hangers or any other objects on the assist grips. When hanging clothes, hang them on the coat hook directly. Always keep the curtain air bag modules free to deploy in the event of a side collision or roll-over accident.

Do not touch the components of the supplementary restraint system after the air bags have inflated:

Touching the components of the supplementary restraint system after the air bags have inflated is dangerous. Immediately after inflation, they are very hot. You could get burned.

SRS Air Bags

Never install any front-end equipment to your vehicle:

Installation of front-end equipment, such as frontal protection bar (kangaroo bar, bull bar, push bar, or other similar devices), snowplow, or winches, is dangerous. The air bag crash sensor system could be affected. This could cause air bags to inflate unexpectedly, or it could prevent the air bags from inflating during an accident. Front occupants could be seriously injured.

Do not modify the suspension:

Modifying the vehicle suspension is dangerous. If the vehicle's height or the suspension is modified, the vehicle will be unable to accurately detect a collision or roll-over accident resulting in incorrect or unexpected air bag deployment and the possibility of serious injuries.

Do not modify a front door or leave any damage unrepaired. Always have an expert repairer, we recommend an Authorised Mazda Repairer inspect a damaged front door:

Modifying a front door or leaving any damage unrepaired is dangerous. Each front door has a side crash sensor as a component of the supplementary restraint system. If holes are drilled in a front door, a door speaker is left removed, or a damaged door is left unrepaired, the sensor could be adversely affected causing it to not detect the pressure of an impact correctly during a side collision. If a sensor does not detect a side impact correctly, the side and curtain air bags and the seat belt pretensioners may not operate normally which could result in serious injury to occupants.

Do not modify the supplementary restraint system:

Modifying the components or wiring of the supplementary restraint system is dangerous. You could accidentally activate it or make it inoperable. Do not make any modifications to the supplementary restraint system. This includes installing trim, badges, or anything else over the air bag modules. It also includes installing extra electrical equipment on or near system components or wiring. An expert repairer, we recommend an Authorised Mazda Repairer can provide the special care needed in the removal and installation of front seats. It is important to protect the air bag wiring and connections to assure that the bags do not accidentally deploy, and that the driver seat slide position sensor is not damaged and the seats retain an undamaged air bag connection.

Do not place luggage or other objects under the front seats:

Placing luggage or other objects under the front seats is dangerous. The components essential to the supplementary restraint system could be damaged, and in the event of a side collision, the appropriate air bags may not deploy, which could result in death or serious injury. To prevent damage to the components essential to the supplementary restraint system, do not place luggage or other objects under the front seats.

Do not operate a vehicle with damaged air bag/seat belt pretensioner system components:

Expended or damaged air bag/seat belt pretensioner system components must be replaced after any collision which caused them to deploy or damage them. Only a trained expert repairer, we recommend an Authorised Mazda Repairer can fully evaluate these systems to see that they will work in any subsequent accident. Driving with an expended or damaged air bag or pretensioner unit will not afford you the necessary protection in the event of any subsequent accident which could result in serious injury or death.

Do not remove interior air bag parts:

Removing any components such as the front seats, front instrument panel, the steering wheel or parts on the front and rear window pillars and along the roof edge, containing air bag parts or sensors is dangerous. These parts contain essential air bag components. The air bag could accidentally activate and cause serious injuries. Always have an Authorised Mazda Repairer remove these parts.

Properly dispose of the air bag system:

Improper disposal of an air bag or a vehicle with live air bags in it can be extremely dangerous. Unless all safety procedures are followed, injury could result. Have an expert repairer, we recommend an Authorised Mazda Repairer safely dispose of the air bag system or scrap an air bag equipped vehicle.

NOTE

- When an air bag deploys, a loud inflation noise can be heard and some smoke will be released. Neither is likely to cause injury, however, the texture of the air bags may cause light skin injuries on body parts not covered with clothing through friction.
- Should you sell your Mazda, we urge you to tell the new owner of its air bag systems and that familiarization with all instructions about them, from the Owner's Manual, is important.
- This highly-visible label warns against the use of a rear-facing child-restraint system on the front passenger seat.



SRS Air Bags

Front Passenger Air Bag Deactivation Switch

▼ Front Passenger Air Bag Deactivation Switch

! WARNING



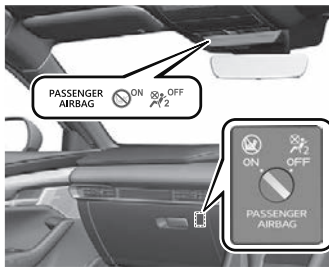

Do not deactivate the front passenger air bag unnecessarily:

Unnecessary deactivation of the front passenger air bag is dangerous. If turned off unnecessarily, the front passenger will not receive the added protection of the air bag. Serious injuries or even death could occur. With the exception of installing a child-restraint system on the front passenger seat, do not turn the air bag deactivation switch to the OFF position.



The front passenger air bag deactivation switch should be used to deactivate the front passenger front and side air bags and also the front passenger seat belt pretensioner system if installing a child-restraint system on the front passenger seat.

When the ignition is switched ON, both front passenger air bag deactivation indicator lights illuminate regardless of the front passenger air bag deactivation switch position. The indicator light turns off after a specified period of time, then turns on/off depending on the conditions as indicated in the following table.

Front Passenger Air Bag Deactivation Switch	Front Passenger Seat/Side Air Bag, Front Passenger Seat Belt Pretensioner Operation Condition	Front Passenger Air Bag Deactivation Indicator Light
OFF position 	Deactivate	 OFF
ON position 	Ready	 ON Turns off after a short period of time.

NOTE

Have the front passenger air bag deactivation switch inspected by an expert repairer; we recommend an Authorised Mazda Repairer if any of these conditions occur:

- The front passenger air bag deactivation indicator light does not illuminate for a specified period of time when the ignition is switched ON.
- The front passenger air bag deactivation indicator light does not turn off after a short period of time when the ignition is switched ON (front passenger air bag deactivation switch is in ON position).

▼ Switch Positions

Before driving, always confirm that the front passenger air bag deactivation switch is in the appropriate position using the auxiliary key according to your requirements.



Do not leave the key in the front passenger air bag deactivation switch:

Unintentional deactivation of the front passenger air bag is dangerous. In an accident, the front passenger will not be properly protected. Serious injuries or even death could occur. To avoid unintentional deactivation, always use the auxiliary key stored in the transmitter body currently being used to operate the front passenger air bag deactivation switch. After deactivating the air bag, put the auxiliary key back into the transmitter body. That way you will not leave the key in the front passenger air bag deactivation switch.

NOTE

After operating the front passenger air bag deactivation switch, put the auxiliary key back into the transmitter body.

OFF

Front passenger front air bag, side air bag and front passenger seat belt pretensioners do not operate.

Switching to OFF position

1. Insert the key into the front passenger air bag deactivation switch and turn the key clockwise until the key points to OFF.
2. Remove the key.
3. Make sure the air bag deactivation indicator light remains illuminated when the ignition is switched ON.

The front passenger front and side air bags and also the seat belt pretensioner system will remain deactivated until the front passenger air bag deactivation switch is turned to the ON position.

ON

Front passenger front air bag, side air bag and front passenger seat belt pretensioners operate. Activate the system only when a child-restraint system is not installed on the front passenger seat.

Switching to ON position

1. Insert the key into the front passenger air bag deactivation switch and turn the key anticlockwise until the key points to ON.
2. Remove the key.
3. Make sure the air bag deactivation indicator light remains illuminated when the ignition is switched ON. The air bag deactivation indicator light turns off after a short period of time.

Supplementary Restraint System Components

▼ Supplementary Restraint System Components

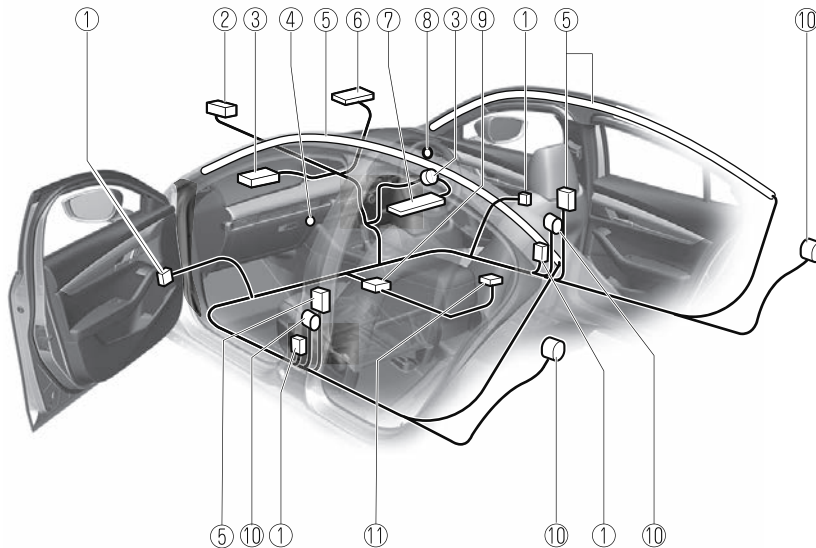

1. Side crash sensors
2. Front air bag sensors
3. Driver/Front passenger inflators and air bags
4. Front passenger air bag deactivation switch (page 2-56)
5. Side and curtain inflators and air bags
6. Front passenger air bag deactivation indicator light (page 2-56)
7. Driver knee inflator and air bag
8. Air bag/seat belt pretensioner system warning indication/warning light (page 7-28)
9. Roll-over sensor, crash sensors, and diagnostic module (SAS unit)
10. Seat belt pretensioners (page 2-28)
11. Driver seat slide position sensor (page 2-59)

How the SRS Air Bags Work

▼ How the SRS Air Bags Work

Your Mazda is equipped with the following types of SRS air bags. SRS air bags are designed to work together with the seat belts to help to reduce injuries during an accident.

The SRS air bags are designed to provide further protection for passengers in addition to the seat belt functions. Be sure to wear seat belts properly.

▼ Seat Belt Pretensioners

The pretensioners operate differently depending on what types of air bags are equipped. For more details about seat belt pretensioner operation, refer to the SRS Air Bag Deployment Criteria (page 2-62).

Front

The front seat belt pretensioners are designed to deploy in moderate or severe frontal, near frontal collisions. In addition, the pretensioners operate when a side collision or a roll-over accident is detected.

Rear Outboard

The rear outboard seat belt pretensioners are designed to deploy in moderate or severe frontal, near frontal collisions.

▼ Driver Air Bag

The driver's air bag is mounted in the steering wheel.

When air bag crash sensors detect a frontal impact of greater than moderate force, the driver's air bag inflates quickly helping to reduce injury mainly to the driver's head or chest caused by directly hitting the steering wheel.

For more details about air bag deployment, refer to "SRS Air Bag Deployment Criteria" (page 2-62). The inflation of the driver's dual-stage air bag is controlled in two energy stages depending on the driver's seat position. The driver's seat slide position sensor is located under the driver's seat. The sensor determines whether the driver's seat is forward of or behind a reference position and sends the seat position to the diagnostic module (SAS unit). The SAS unit is designed to control the deployment of the driver's air bag depending on how close the driver's seat is to the steering wheel.

During an impact of moderate severity, the driver's air bag deploys with lesser energy, whereas during more severe impacts and when the driver's seat is behind the reference position, it deploys with more energy.

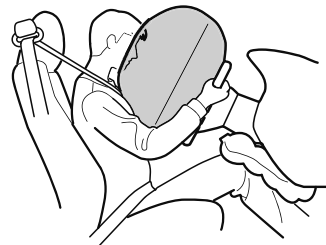

SRS Air Bags

▼ Front Passenger Air Bag

The front passenger air bag is mounted in the front passenger instrument panel. The inflation mechanism for the front passenger air bag is the same as the driver's air bag.

For more details about air bag deployment, refer to "SRS Air Bag Deployment Criteria" (page 2-62).

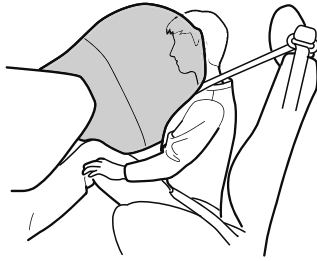

▼ Driver Knee Air Bag

The knee air bag is equipped under the instrument panel.

If the air bag crash sensors receive a frontal impact of greater than moderate force, the knee air bag deploys immediately to reduce impact to the driver's legs.

For more details about air bag deployment, refer to "SRS Air Bag Deployment Criteria" (page 2-62).

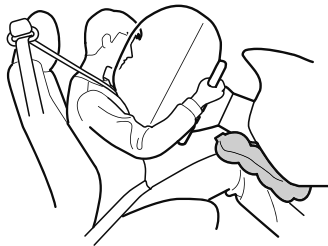

▼ Side Air Bags

The side air bags are mounted in the outboard sides of the front seatbacks. When the air bag crash sensors detect a side impact of greater than moderate force, the system inflates the side air bag only on the side in which the vehicle was hit. The side air bag inflates quickly to reduce injury to the driver or front passenger's chest caused by directly hitting interior parts such as a door or window.

For more details about air bag deployment, refer to "SRS Air Bag Deployment Criteria" (page 2-62).

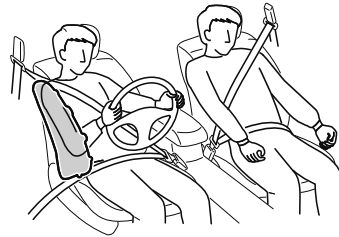

▼ Curtain Air Bags

The curtain air bags are mounted in the front and rear window pillars, and the roof edge along both sides.

When the air bag crash sensors detect a side impact of greater than moderate force, the curtain air bag inflates quickly and helps to reduce injury mainly to the driver and front and rear outboard passengers' heads caused by directly hitting interior parts such as a door or window.

For more details about air bag deployment, refer to "SRS Air Bag Deployment Criteria" (page 2-62).

In a side impact:

Greater than moderate impact to one side of the vehicle will cause the curtain air bag on that side only to inflate.

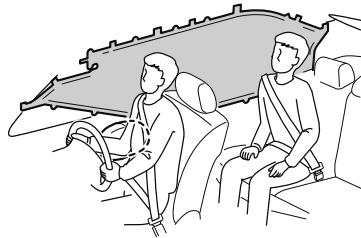

Only one side curtain air bag will deploy on the side of the vehicle that receives the force of an impact.

In a roll-over:

In response to a vehicle roll-over, both curtain air bags inflate.

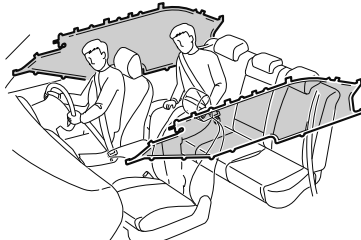

Both curtain air bags will deploy after the roll-over accident is detected.

▼ Warning Light/Beep

A system malfunction or operation conditions are indicated by a warning. Refer to Air Bag/Seat Belt Pretensioner System Warning Indication/Warning Light on page 7-28.

Refer to Air Bag/Seat Belt Pretensioner System Warning Beep on page 7-37.







Essential Safety Equipment
SRS Air Bags

SRS Air Bag Deployment Criteria

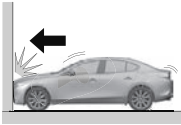
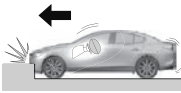
▼ **SRS Air Bag Deployment Criteria**

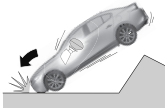
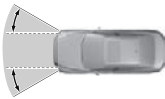
This chart indicates the applicable SRS equipment that will deploy depending on the type of collision.

(The illustrations are the representative cases of collisions.)

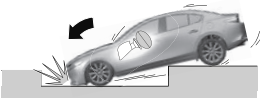
SRS equipment	Types of collision			
	A severe frontal/near frontal collision	A severe side collision	A roll-over/near roll-over*2	A rear collision
	 			
	 			
				

Essential Safety Equipment
SRS Air Bags

SRS equip- ment	Types of collision			
	A severe frontal/near frontal collision	A severe side collision	A roll-over/near roll-over*2	A rear collision
Front seat belt pretensioner	X*1	X*1	X*1	No air bag and seat belt pretensioner will be activated in a rear collision.
Rear seat belt pretensioner*	X	X	X	
Driver air bag	X	—	—	
Front passenger air bag	X*1	—	—	
Knee Airbag	X	—	—	
Side air bag	—	X*1 (impact side only)	—	
Curtain air bag	—	X (impact side only)	X (both sides)	

X: The SRS air bag equipment deploys in a collision.

—: The SRS air bag equipment does not deploy in a collision.

*1 **(With Front Passenger Air Bag Deactivation Switch)**

The front passenger front and side air bags and seat belt pretensioner are designed to deploy depending on the status of the front passenger air bag deactivation switch.

*2 In a roll-over accident, the seat belt pretensioners and the curtain air bags deploy.

NOTE

In a frontal offset collision, the equipped air bags and pretensioners may all deploy depending on the direction, angle, and rate of impact.

Limitations to SRS Air Bag

▼ Limitations to SRS Air Bag

In severe collisions such as those described previously in "SRS Air Bag Deployment Criteria", the applicable SRS air bag equipment will deploy. However, in some accidents, the equipment may not deploy depending on the type of collision and its severity.

Limitations to front/near front collision detection:

The following illustrations are examples of front/near front collisions that may not be detected as severe enough to deploy the SRS air bag equipment.

Impacts involving trees or poles

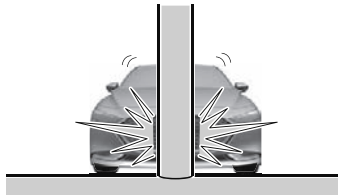

Frontal offset impact to the vehicle



Rear-ending or running under a truck's tail gate

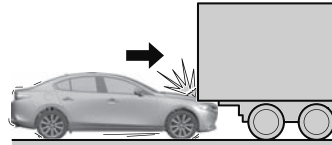

Limitations to side collision detection:

The following illustrations are examples of side collisions that may not be detected as severe enough to deploy the SRS air bag equipment.

Side impacts involving trees or poles



Side impacts with two-wheeled vehicles

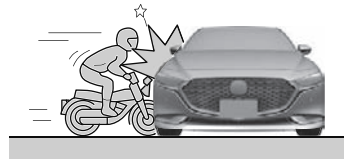

Limitations to roll-over detection:

The following illustration is an example of an accident that may not be detected as a roll-over accident. Therefore, the front seat belt pretensioners and curtain air bags may not deploy.

Pitch end over end

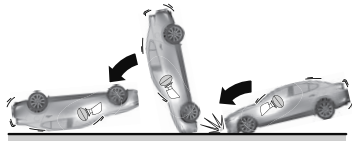

Constant Monitoring

▼ Constant Monitoring

The following components of the air bag systems are monitored by a diagnostic system:

- Front air bag sensors
- Crash sensors, and diagnostic module (SAS unit)
- Side crash sensors
- Air bag modules
- Seat belt pretensioners
- Air bag/Seat belt pretensioner system warning indication/warning light
- Related wiring
- Driver seat slide position sensor
- Front passenger air bag deactivation switch
- Front passenger air bag deactivation indicator light

The diagnostic module continuously monitors the system's readiness. This begins when the ignition is switched ON and continues while the vehicle is being driven.

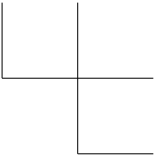
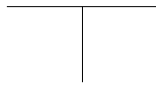
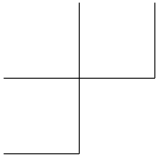

MEMO

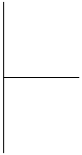

2-66

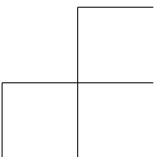
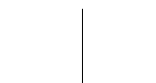
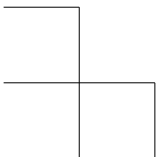

3 Before Driving

Use of various features, including keys, doors, mirrors and windows.

Keys.....	3-2	Windows.....	3-31
Keys.....	3-2	Power Windows.....	3-31
Keyless Entry System.....	3-4	Sunroof*	3-34
Advanced Keyless Entry		Security System.....	3-37
System.....	3-8	Modification and Add-On	
Advanced Keyless Entry System*	3-8	Equipment.....	3-37
.....	3-8	Immobilizer System.....	3-37
Operational Range.....	3-9		
 		Driving Tips.....	3-39
Doors and Locks.....	3-10	Running-In Period.....	3-39
Door Locks.....	3-10	Saving Fuel and Protection of the	
Liftgate/Boot Lid.....	3-17	Environment.....	3-39
		Hazardous Driving.....	3-40
Fuel and Emission.....	3-21	Floor Mat.....	3-41
Fuel and Engine Exhaust		Rocking the Vehicle.....	3-42
Precautions.....	3-21	Winter Driving.....	3-42
Fuel-Filler Flap and Cap.....	3-25	Driving In Flooded Area.....	3-44
Mirrors.....	3-27	Towing.....	3-45
Mirrors.....	3-27	Towing Caravans and	
		Trailers.....	3-45

*Some models. **3-1**

Keys

Keys

▼ Keys

WARNING

Do not leave the key in your vehicle with children and keep them in a place where your children will not find or play with them:

Leaving children in a vehicle with the key is dangerous. This could result in someone being badly injured or even killed. Children may find these keys to be an interesting toy to play with and could cause the power windows or other controls to operate, or even make the vehicle move.

CAUTION

- Because the key (transmitter) uses low-intensity radio waves, it may not function correctly under the following conditions:
 - The key (transmitter) is carried with communication devices such as cellular phones.
 - The key (transmitter) contacts or is covered by a metal object.
 - The key (transmitter) is near electronic devices such as personal computers.
 - Non-Mazda genuine electronic equipment is installed in the vehicle.
 - There is equipment which discharges radio waves near the vehicle.

- The key (transmitter) may consume battery power excessively if it receives high-intensity radio waves. Do not place the key (transmitter) near electronic devices such as televisions or personal computers.
- To avoid damage to the key (transmitter), DO NOT:
 - Drop the key (transmitter).
 - Get the key (transmitter) wet.
 - Disassemble the key (transmitter).
 - Expose the key (transmitter) to high temperatures on places such as the instrument panel or bonnet, under direct sunlight.
 - Expose the key (transmitter) to any kind of magnetic field.
 - Place heavy objects on the key (transmitter).
 - Put the key (transmitter) in an ultrasonic cleaner.
 - Put any magnetized objects close to the key (transmitter).

NOTE

The driver must carry the key (transmitter) to ensure the system functions properly.

Transmitter

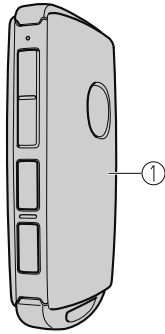

1. Transmitter (page 3-5)

Auxiliary key

There is a removable auxiliary key inside the transmitter.

Removing the auxiliary key

1. Remove the lower cover while pressing the knob in the direction of the arrow.

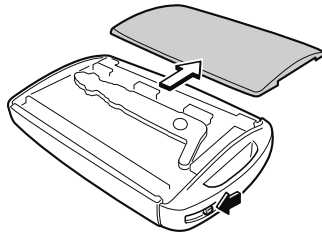

2. Remove the auxiliary key.

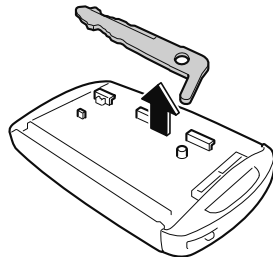

Installing the auxiliary key

1. Install the auxiliary key as the illustration.

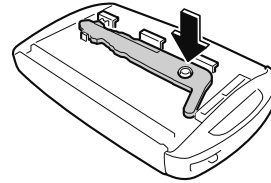

2. Insert the tabs of the lower cover into the slots of the transmitter and install the lower cover.

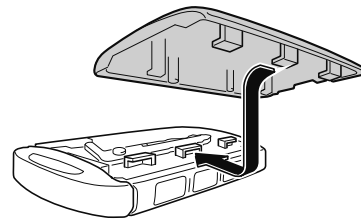

Key code number plate

A code number is stamped on the plate attached to the key set; detach this plate and store it in a safe place (not in the vehicle) for use if you need to make a replacement key (auxiliary key).

Also write down the code number and keep it in a separate safe and convenient place, but not in the vehicle.

If your key (auxiliary key) is lost, consult your Authorised Mazda Repairer and have your code number ready.



1. Key code number plate

Keyless Entry System

▼ Keyless Entry System

This system uses the key buttons to remotely lock and unlock the doors, liftgate/boot lid, and fuel-filler flap, and opens the boot lid.

The system can start the engine without having to take the key out of your purse or pocket.

System malfunctions or warnings are indicated by the following warning lights or beeps.

Check the displayed message for more information and, if necessary, have the vehicle inspected at an expert repairer, we recommend an Authorised Mazda Repairer, according to the indication.

- KEY Warning Indication/Warning Light (Red)
Refer to KEY Warning Indication/Warning Light (Red) on page 7-29.
- Ignition Not Switched Off (STOP) Warning Beep
Refer to Ignition Not Switched Off (STOP) Warning Beep on page 7-38.
- Key Removed from Vehicle Warning Beep
Refer to Key Removed from Vehicle Warning Beep on page 7-38.

If you have a problem with the key, consult an expert repairer, we recommend an Authorised Mazda Repairer.

If your key is lost or stolen, consult an Authorised Mazda Repairer as soon as possible for a replacement and to make the lost or stolen key inoperative.

CAUTION

Changes or modifications not expressly approved by the party responsible for compliance could void the user's authority to operate the equipment.

NOTE

- *The keyless entry system operation may vary due to local conditions.*
- *The keyless entry system is fully operational when the ignition is switched off. The system does not operate if the ignition is switched to any position other than off.*
- *If the key does not operate when pressing a button or the operational range becomes too small, the battery may be weak. To install a new battery, refer to Key Battery Replacement (page 6-25).*
- *Battery life is about 1 year. Replace the battery with a new one if the messages are displayed in the instrument cluster. Replacing the battery about once a year is recommended because the KEY warning indication may not display depending on the rate of battery depletion.*
- *Additional keys can be obtained at an Authorised Mazda Repairer. Up to 6 keys can be used with the keyless functions per vehicle. Bring all keys to an Authorised Mazda Repairer when additional keys are required.*

▼ Transmitter

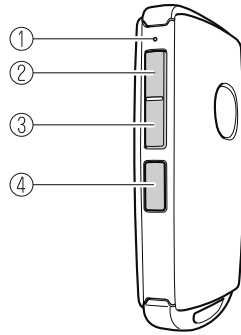

1. Operation indicator light
2. Lock button (🔒)
3. Unlock button (🔓)
4. Boot button (Saloon) (🚗)

NOTE

- The headlights turn on/off by operating the transmitter. Refer to Leaving Home Light on page 4-53.
- **(With the advanced keyless function)**
A beep sound can be heard for confirmation when the doors, liftgate/boot lid, and fuel-filler flap are locked/unlocked using the key. If you prefer, the beep sound can be turned off. The volume of the beep sound can also be changed. Refer to the Settings section in the MZD Connect Owner's Manual.

The operation indicator light flashes when the buttons are pressed.

Lock button

To lock the doors, liftgate/boot lid, and fuel-filler flap, press the lock button and the hazard warning lights will flash once.

(With the advanced keyless function)

A beep sound will be heard once.

**NOTE**

- If the lock button is pressed with any door or liftgate/boot lid open, any closed door can be locked. Close any open door and liftgate/boot lid to lock.
- Make sure all the doors, liftgate/boot lid, and fuel-filler flap are locked after pressing the button.

Unlock button

To unlock the doors, liftgate/boot lid, and fuel-filler flap, press the unlock button and the hazard warning lights will flash twice.

(With the advanced keyless function)

A beep sound will be heard twice.

**NOTE**

- The system can be set to unlock the driver's door and fuel-filler flap by pressing the UNLOCK button on the key, and to unlock all the doors and liftgate/boot lid by pressing the button again within 5 seconds. Refer to the Settings section in the MZD Connect Owner's Manual.
- **(Auto re-lock function)**
After unlocking with the key, all the doors, liftgate/boot lid, and fuel-filler flap will automatically lock if any of the following operations are not performed within about 30 seconds.

Keys

- A door or the liftgate/boot lid is opened.
- The ignition is switched to any position other than off.

The time required for the doors to lock automatically can be changed.
Refer to the Settings section in the MZD Connect Owner's Manual.

Boot button (Saloon)

To open the boot lid, press and hold the boot button until the boot lid opens.



Power saving function

By turning on the transmitter power saving function, the advanced keyless entry*¹ and push button start system functions turn off and the battery power consumption of the transmitter is restricted.

The remote control function is operational by operating the transmitter switch even while the power saving function is turned on. However, the operation indicator light of the transmitter does not turn on/flash.

Turning on the power saving function

After you have turned on the power saving function according to the following procedure, the hazard warning lights and sound operate*¹ one time.

1. Press the lock button on the transmitter 4 times within 3 seconds to turn on the operation indicator light.
2. Press the lock button continuously for 1.5 seconds or longer while the operation indicator light turns on (for 5 seconds).

3. Press any of the buttons on the transmitter to make sure that the operation indicator light does not turn on/flash.

Turning off the power saving function

After you have turned off the power saving function according to the following procedure, the hazard warning lights and sound operate*¹ one time.

1. Press any of the buttons on the transmitter to make sure that the operation indicator light does not turn on/flash.
2. Press the lock button on the transmitter 4 times within 3 seconds to turn on the operation indicator light.
3. Press the lock button continuously for 1.5 seconds or longer while the operation indicator light turns on (for 5 seconds).

*¹ With the advanced keyless function

▼ Operational Range

The system operates only when the driver is in the vehicle or within operational range while the key is being carried.

Starting the Engine

NOTE

- Starting the engine may be possible even if the key is outside of the vehicle and extremely close to a door and window, however, always start the engine from the driver's seat.

If the vehicle is started and the key is not in the vehicle, the vehicle will not restart after it is shut off and the ignition is switched to off.

· The luggage compartment/boot is out of the assured operational range, however, if the key (transmitter) is operable the engine will start.

With the advanced keyless function

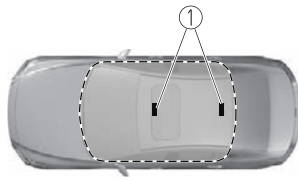

1. Interior aerial
2. Operational range

Without the advanced keyless function

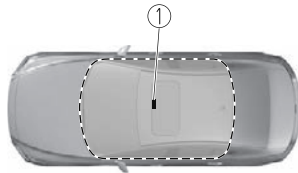

1. Interior aerial
2. Operational range

NOTE

The engine may not start if the key is placed in the following areas:

- Around the instrument panel
- In the storage compartments such as the glove compartment or the centre console
- On the rear parcel shelf (saloon)

▼ Key Suspend Function

If a key is left in the vehicle, the functions of the key left in the vehicle are temporarily suspended to prevent theft of the vehicle.

To restore the functions, press the unlock button on the functions-suspended key in the vehicle.

Advanced Keyless Entry System

Advanced Keyless Entry System*

▼ Advanced Keyless Entry System

WARNING

Radio waves from the key may affect medical devices such as pacemakers:

Before using the key near people who use medical devices, ask the medical device manufacturer or your physician if radio waves from the key will affect the device.

The advanced keyless function allows you to lock/unlock the door, liftgate/boot lid, and fuel-filler flap, or open the liftgate/boot lid while carrying the key.

System malfunctions or warnings are indicated by the following warning lights or beeps.

- Touch Sensor Inoperable Warning Beep
Refer to Touch Sensor Inoperable Warning Beep (With the advanced keyless function) on page 7-38.
- Key Left-in-luggage Compartment/Boot Warning Beep
Refer to Key Left-in-luggage Compartment/Boot Warning Beep (With the advanced keyless function) on page 7-38.
- Key Left-in-vehicle Warning Beep
Refer to Key Left-in-vehicle Warning Beep (With the advanced keyless function) on page 7-39.

NOTE

The advanced keyless entry system functions can be deactivated to prevent any possible adverse effect on a user wearing a pacemaker or other medical device. If the system is deactivated, you will be unable to start the engine by carrying the key. Consult an expert repairer; we recommend an Authorised Mazda Repairer for details. If the advanced keyless entry system has been deactivated, you can start the engine by following the procedure indicated when the key battery goes dead. Refer to Engine Start Function When Key Battery is Dead on page 4-8.

Advanced Keyless Entry System

Operational Range

▼ Operational Range

The system operates only when the driver is in the vehicle or within operational range while the key is being carried.

NOTE

When the battery power is low, or in places where there are high-intensity radio waves or noise, the operational range may become narrower or the system may not operate. For determining battery replacement, Refer to Keyless Entry System on page 3-4.

▼ Locking, Unlocking the Doors and the Liftgate/Boot Lid

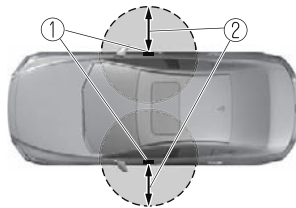

1. Exterior aerial
2. 80 cm (31 in)
3. Operational range

NOTE

- *The system may not operate if you are too close to the windows or door handles, or liftgate/boot lid.*
- *If the key is left in the following areas and you leave the vehicle, the doors may be locked depending on the radio wave conditions even if the key is left in the vehicle.*
 - *Around the instrument panel*

- *In the storage compartments such as the glove compartment or the centre console*
- *On the rear parcel shelf (saloon)*
- *Next to a communication device such as a mobile phone*

▼ Opening the Liftgate/Boot Lid

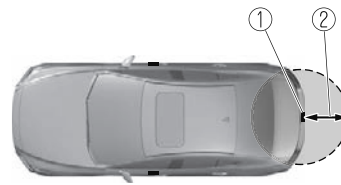

1. Exterior aerial
2. 80 cm (31 in)
3. Operational range

Doors and Locks

Door Locks

▼ Door Locks

WARNING

Always take all children and pets with you or leave a responsible person with them:

Leaving a child or a pet unattended in a parked vehicle is dangerous. In hot weather, temperatures inside a vehicle can become high enough to cause brain damage or even death.

Do not leave the key in your vehicle with children and keep them in a place where your children will not find or play with them:

Leaving children in a vehicle with the key is dangerous. This could result in someone being badly injured or even killed.

Keep all doors locked when driving:

Unlocked doors in a moving vehicle are dangerous. Passengers can fall out if a door is accidentally opened and can more easily be thrown out in an accident.

Always close all the windows and sunroof, lock the doors, fuel-filler flap, and liftgate/boot lid and take the key with you when leaving your vehicle unattended:

Leaving your vehicle unlocked is dangerous as children could lock themselves in a hot vehicle, which could result in death. Also, a vehicle left unlocked becomes an easy target for thieves and intruders.

After closing the doors and the liftgate/boot lid, always verify that they are securely closed:

Doors and the liftgate/boot lid not securely closed are dangerous, if the vehicle is driven with a door and the liftgate/boot lid not securely closed, the door and the liftgate/boot lid could open unexpectedly resulting in an accident.

Always confirm the safety around the vehicle before opening a door and the liftgate/boot lid:

Suddenly opening a door and the liftgate/boot lid is dangerous. A passing vehicle or a pedestrian could be hit and cause an accident.

CAUTION

➤ Always confirm the conditions around the vehicle before opening/closing the doors and the liftgate/boot lid and use caution during strong winds or when parked on an incline. Not being aware of the conditions around the vehicle is dangerous because fingers could get caught in the door and the liftgate/boot lid or a passing pedestrian could be hit, resulting in an unexpected accident or injury.

NOTE

· Always stop the engine and lock the doors. In addition, to prevent theft of valuables, do not leave them inside the cabin.

Doors and Locks

· If the key is left in the following areas and you leave the vehicle, the doors may be locked depending on the radio wave conditions even if the key is left in the vehicle.

- Around the instrument panel
 - In the storage compartments such as the glove compartment or the centre console
 - On the rear parcel shelf (saloon)
 - Next to a communication device such as a mobile phone
- When the ignition is switched to ACC or ON, the vehicle lock-out prevention feature prevents you from locking yourself out of the vehicle.

All the doors, fuel-filler flap, and liftgate/boot lid will automatically unlock if they are locked using the power door locks with any door or liftgate open.

If all the doors are closed even though the liftgate/boot lid is open, all the doors will lock.

The vehicle lock-out prevention feature does not operate while the ignition is switched off.

When all doors, fuel-filler flap, and liftgate/boot lid are locked using the power door lock with any door or the liftgate/boot lid open, the closed doors, fuel-filler flap, and liftgate/boot lid are locked. After that, when all doors and the liftgate/boot lid are closed, all doors, fuel-filler flap, and liftgate/boot lid are locked. However, if the key is inside the vehicle, all doors, fuel-filler flap, and liftgate/boot lid are automatically unlocked.

(With the advanced keyless function)

The beep sound is heard for about 10 seconds to notify the driver that the key has been left in the vehicle.

(Without the advanced keyless function)

The horn sound is heard twice to notify the driver that the key has been left in the vehicle.

· **(Door unlock (control) system with collision detection)**

This system automatically unlocks the doors, fuel-filler flap, and liftgate/boot lid in the event the vehicle is involved in an accident to allow passengers to get out of the vehicle immediately and prevent being trapped inside. While the ignition is switched ON and in the event the vehicle receives an impact strong enough to inflate the air bags, all the doors, fuel-filler flap, and liftgate/boot lid are automatically unlocked after about 6 seconds have elapsed from the time of the accident.

The doors, fuel-filler flap, and liftgate/boot lid may not unlock depending on how an impact is applied, the force of the impact, and other conditions of the accident.

Doors and Locks

▼ Unlocking with Auxiliary Key

Only the driver's door can be unlocked using the auxiliary key.

Refer to Keys on page 3-2.

Insert the auxiliary key while the driver's door handle is pulled and turn the key to the unlock side. Turn the auxiliary key back to its original position before removing it.

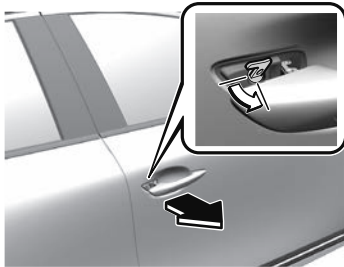

NOTE

If you attempt to open the driver's door using an unauthorised auxiliary key, the key cylinder will spin around but the door will not unlock.

▼ Locking, Unlocking with Touch Sensor, Door Handle (With the advanced keyless function)

By touching the sensing area of the touch sensor, various locking/unlocking operations can be done without taking the key out of a bag or pocket.

There are two types of touch sensors used for locking and unlocking, and each sensor is built into the outer door handle on the driver and front passenger's doors.

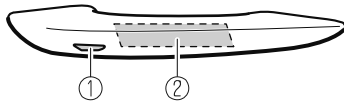

1. Sensing area of door lock touch sensor (Depression on outer side of door handle)
2. Sensing area of door release touch sensor (Inner side of door handle)

NOTE

· When locking/unlocking with the transmitter carried, securely touch the sensing area of the touch sensor as follows.

Locking

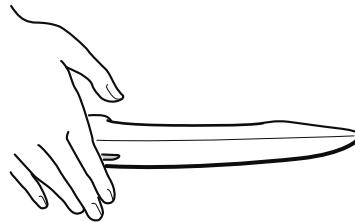

Unlocking

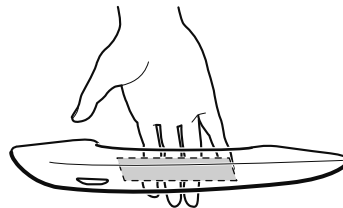

· The system may not operate normally under the following conditions.

· You touch the sensing area of the door lock touch sensor and the sensing area of the door release touch sensor at the same time.

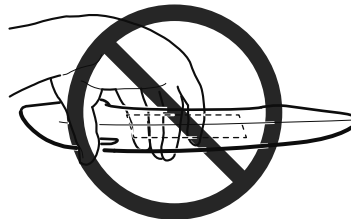

Doors and Locks

- You touch the sensing area of the touch sensor while wearing gloves.
- Foreign matter such as snow or dirt is stuck on the sensing area of the touch sensor.
- You pull the door handle just after touching the sensing area of the touch sensor.
- The system may operate if the outer side door handle of a front door is splashed with water by a car wash or rain while the transmitter is in the operation range.
- If the system does not operate even though you touch the sensing area of the touch sensor correctly, release the touch sensor once, and then touch the sensing area of the touch sensor again after waiting about 3 seconds.

Locking

When locking, touch the sensing area of the door lock touch sensor with all of the following conditions met.

- The ignition is switched OFF.
- All the doors are closed.
- You are carrying the transmitter.

The following locations are locked by touching the sensing area of the door lock touch sensor.

- All doors
- Fuel-filler flap
- Liftgate/boot lid

When locking, the hazard warning lights and sound operate one time.

Unlocking

When unlocking, touch the sensing area of the door release touch sensor with all of the following conditions met.

- The ignition is switched OFF.

- The driver's door is locked.
- Three seconds or longer have passed since the doors were locked.
- You are carrying the transmitter.

The following locations are unlocked by touching the sensing area of the door release touch sensor.

- All doors
- Fuel-filler flap
- Liftgate/boot lid

NOTE

- *The location to be unlocked can be changed. Refer to the Settings section in the MZD Connect Owner's Manual.*

When unlocking, the hazard warning lights and sound operate two times.

NOTE

- *Confirm that all the doors and liftgate/boot lid are securely locked. For the liftgate/boot lid, move it without pressing the electric liftgate/boot lid opener to verify that the liftgate/boot lid has not been left ajar.*
- *A beep sound is heard for confirmation when the doors, fuel-filler flap, and liftgate/boot lid are locked/unlocked using the touch sensor. If you prefer, the beep sound can be turned off. The volume of the beep sound can also be changed. Refer to the Settings section in the MZD Connect Owner's Manual.*
- *The setting can be changed so that the doors, fuel-filler flap, and liftgate/boot lid are locked automatically without touching the sensing area of the touch sensor.*

Doors and Locks

Refer to the Settings section in the MZD Connect Owner's Manual.

(Walk-away auto lock function)

A beep sound is heard when all doors and the liftgate/boot lid are closed while the transmitter is being carried. All the doors, fuel-filler flap, and liftgate/boot lid are locked automatically when the transmitter is out of the operational range. Also, the hazard warning lights flash once. (Even if the driver is in the operational range, all the doors, fuel-filler flap, and liftgate/boot lid are locked automatically after about 30 seconds.) If you are out of the operational range before the doors and the liftgate/boot lid are completely closed or another transmitter is left in the vehicle, the walk-away auto lock function will not work. Always make sure that all doors and the liftgate/boot lid are closed and locked before leaving the vehicle. The walk-away auto lock function does not close the power windows.

(Auto re-lock function)

After unlocking with the touch sensor, all the doors, fuel-filler flap, and liftgate/boot lid will automatically lock if any of the following operations are not performed within about 30 seconds.

- Opening a door or the liftgate/boot lid.
- Switching the ignition to any position other than off.

The time required for the doors to lock automatically can be changed.

Refer to the Settings section in the MZD Connect Owner's Manual.

▼ Locking, Unlocking with Transmitter

The following locations can be locked/unlocked by operating the keyless entry system transmitter. Refer to Keyless Entry System (page 3-4).

- All doors
- Fuel-filler flap
- Liftgate/Boot lid

▼ Locking, Unlocking with Door-Lock Switch

The following locations are locked/unlocked by pressing the door-lock switch.

- All doors
- Fuel-filler flap
- Liftgate/Boot lid

Driver's door

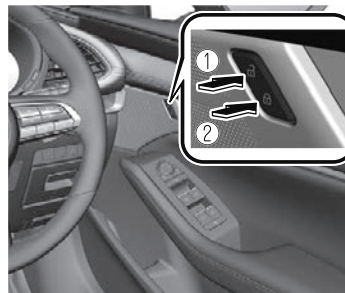

1. Unlock
2. Lock

Doors and Locks

Hatchback

Liftgate (Lock only)



Locking the doors from the outside using the door-lock switch

Using the driver's door-lock switch

Press the lock side of the door-lock switch with the door open, and close the door.

Using the door-lock switch of the liftgate

Press the door-lock switch with the liftgate open, and close the liftgate.

NOTE

When any of the following conditions is met, the doors cannot be locked from the outside using the door-lock switch.

- The transmitter is left in the vehicle.
- The ignition is switched to a position other than OFF.

▼ Auto Lock/Unlock Function

! WARNING

Do not pull the inner handle on a front door:

Pulling the inner handle on a front door while the vehicle is moving is dangerous. Passengers can fall out of the vehicle if the door opens accidentally, which could result in death or serious injury.

- When the vehicle speed exceeds 20 km/h (12 mph), all the doors, fuel-filler flap, and liftgate/boot lid lock automatically.
- When the ignition is switched off, all the doors, fuel-filler flap, and liftgate/boot lid unlock automatically.

The auto lock/unlock function settings can be changed.

Refer to the Settings section in the MZD Connect Owner's Manual.

▼ Locking, Unlocking with Door-Lock Knob

Operation from inside

To lock any door from the inside, press the door-lock knob.

To unlock, pull it outward.

This does not operate the other door locks.

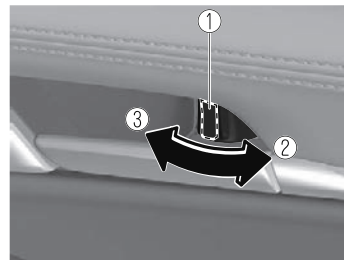

Before Driving

Doors and Locks

1. Unlocked: Red indicator
2. Unlock
3. Lock

Operation from outside

To lock any door using its door-lock knob from the outside, press the door-lock knob to the lock position and close the door (holding the door handle in the open position is not required). This does not operate the other door locks.

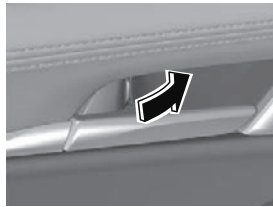

NOTE

When locking the door this way:

- Be careful not to leave the key inside the vehicle.
- The doors cannot be locked using the driver's door lock knob if any door is open when the ignition is switched to ACC or ON.

3-16

▼ Rear Door Child Safety Locks

Rear doors that have been locked using the child safety lock switched to the lock side cannot be opened from inside the vehicle. For child safety, switch the child safety lock on both rear doors to the lock side. When opening a rear door with the child safety lock switched to the lock side, pull the outer door handle with the lock knob inside the vehicle switched to the unlock side.

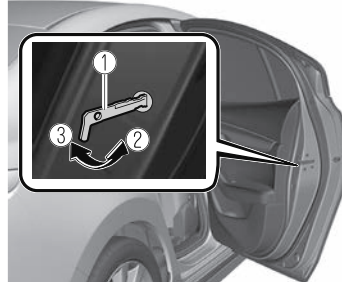

1. Auxiliary key (page 3-2)
2. Lock
3. Unlock

Liftgate/Boot Lid

▼ Liftgate/Boot Lid

⚠ WARNING

Never allow a person to ride in the luggage compartment/boot:

Allowing a person to ride in the luggage compartment/boot is dangerous. The person in the luggage compartment/boot could be seriously injured or killed during sudden braking or a collision.

Do not drive with the liftgate/boot lid open:

Exhaust gas in the cabin of a vehicle is dangerous. An open liftgate/boot lid in a moving vehicle will cause exhaust gas to be drawn into the cabin. This gas contains CO (carbon monoxide), which is colourless, odourless, and highly poisonous, and it can cause loss of consciousness and death. Moreover, an open liftgate/boot lid could cause occupants to fall out in an accident.

Do not stack or leave loaded luggage unsecured in the luggage compartment:

Otherwise, the luggage may move or collapse, resulting in injury or an accident. In addition, do not load luggage higher than the seatbacks. It may affect the side or rear field of view.

⚠ CAUTION

- Before opening the liftgate/boot lid, remove any snow and ice accumulation on it. Otherwise, the liftgate/boot lid could close under the weight of the snow and ice resulting in injury.

- Be careful when opening/closing the liftgate/boot lid during strong winds. If a strong gust blows against the liftgate/boot lid, it could close suddenly resulting in injury.
- Fully open the liftgate/boot lid and make sure that it stays open. If the liftgate/boot lid is only opened partially, it could slam shut by vibration or wind gusts resulting in injury.
- When loading or unloading luggage in the luggage compartment/boot, turn off the engine. Otherwise, you could get burned by the heat of the exhaust gas.
- Be careful not to apply excessive force to the damper stay on the liftgate such as by putting your hand on the stay. Otherwise, the damper stay may bend and affect the liftgate operation.



1. Damper stay

- Do not modify or replace the liftgate damper stay. Consult an expert repairer, we recommend an Authorised Mazda Repairer if a liftgate damper stay is deformed or damaged for reasons such as a collision or if there is some other problem.

Doors and Locks

▼ Opening and Closing the Liftgate/ Boot Lid

Opening the liftgate (Hatchback)

Using the electric liftgate opener

Unlock the doors and liftgate, then press the electric liftgate opener on the liftgate and raise it when the latch releases.

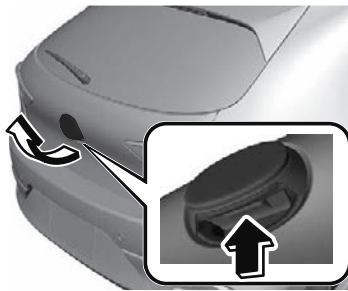

NOTE

(With the advanced keyless function)

- A locked liftgate can also be opened while the key is being carried.
- When opening the liftgate with the doors and the liftgate locked, it may require a few seconds for the liftgate latch to release after the electric liftgate opener is pressed.
- The liftgate can be closed when the doors are locked with the key left in the vehicle. However, to prevent locking the key in the vehicle, the liftgate can be opened by pressing the electric liftgate opener. If the liftgate cannot be opened despite doing this procedure, first push the liftgate completely closed, then press the electric liftgate opener to fully open the liftgate.

- When the liftgate latch is released by pressing the electric liftgate opener, the liftgate raises slightly. If the liftgate is not operated for a certain period of time, the liftgate cannot be raised.

To open

Press the electric liftgate opener again.

To close

To close the liftgate from its slightly raised position, open it first by pressing the electric liftgate opener, then close it after waiting at least 1 second.

- If the liftgate is not fully closed, the driver is notified by a warning indicated in the instrument cluster.
- If the vehicle battery is dead or there is a malfunction in the electrical system and the liftgate cannot be unlocked, the liftgate can be opened by performing the emergency procedure.

Refer to *When Liftgate/Boot Lid Cannot be Opened* on page 7-42.

Opening the boot lid (Saloon)

Using the electric boot lid opener

Unlock the doors and boot lid, then press the electric boot lid opener on the boot lid and raise it when the latch releases.

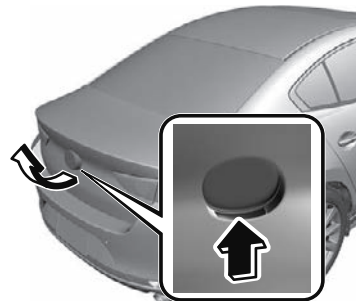

NOTE***(With the advanced keyless function)***

- A locked boot lid can also be opened while the key is being carried.
- When opening the boot lid with the doors locked, it may require a few seconds for the boot lid latch to release after the electric boot lid opener is pressed.
- The boot lid can be closed when the doors are locked with the key left in the vehicle. However, to prevent locking the key in the vehicle, the boot lid can be opened by pressing the electric boot lid opener. If the boot lid cannot be opened despite doing this procedure, press the electric boot lid opener to fully open the boot lid after pushing the boot lid completely closed.
- If the vehicle battery is dead or there is a malfunction in the electrical system and the boot lid cannot be unlocked, the boot lid can be opened by performing the emergency procedure. Refer to *When Liftgate/Boot Lid Cannot be Opened* on page 7-42.

Closing the liftgate/boot lid

Lower the liftgate/boot lid slowly using the liftgate/boot lid grip recess, then push the liftgate/boot lid closed using both hands.

Do not slam it. Pull up on the liftgate/boot lid to make sure it is secure.

(Hatchback)**(Saloon)**

Doors and Locks

▼ Luggage Compartment

Luggage compartment cover (Hatchback)

! WARNING

Do not place anything on top of the cover:
Placing luggage or other cargo on top of the luggage compartment cover is dangerous. During sudden braking or a collision, the cargo could become a projectile that could hit and injure someone. The vehicle has a light weight luggage compartment cover to keep the contents of your luggage area out of sight; it will not retain heavy objects that are not tied down in an accident such as a rollover. Tie down all heavy objects, whether luggage or cargo, using the tie down hooks.

Make sure luggage and cargo are secured before driving:

Not securing cargo while driving is dangerous as it could move or be crushed during sudden braking or a collision and cause injury.

! CAUTION

➤ *Make sure the luggage compartment cover is firmly secured. If it is not firmly secured, it could unexpectedly disengage resulting in injury.*

The luggage compartment can be accessed by opening the liftgate when the straps are attached to the sides of the liftgate.



Removing the luggage compartment cover

This cover can be removed for more room.

1. Remove the straps from the hooks.
2. Press the luggage compartment cover upward from near the pins and remove the luggage compartment cover from the pins.

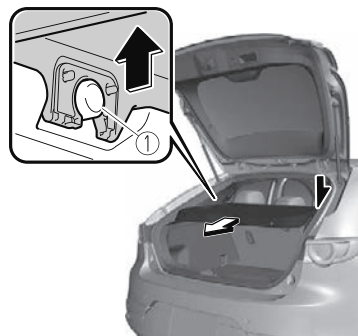

1. Pin

3. Lift the front end of the luggage compartment cover and remove it.

Fuel and Engine Exhaust Precautions

▼ Fuel Requirements (Australia)

Vehicles with catalytic converters or oxygen sensors must use **ONLY UNLEADED FUEL**, which will reduce exhaust emissions and keep spark plug fouling to a minimum.

The vehicle will perform best with fuel listed in the table.

Fuel	Research Octane Number
Regular unleaded fuel (Conforming to Fuel Quality Standards Act 2000)	90 or above

Fuel with a lower rating will negatively affect the emission control system performance and could also cause engine knocking and serious engine damage.

CAUTION

- **USE ONLY UNLEADED FUEL.**
Leaded fuel is harmful to the catalytic converter and oxygen sensors and will lead to deterioration of the emission control system and or failures.
- *This vehicle can only use oxygenated fuels containing no more than 10 % ethanol by volume. Damage to the vehicle may occur when ethanol exceeds this recommendation, or if the petrol contains any methanol. Stop using gasohol of any kind if your vehicle engine is performing poorly.*
- *Never add fuel system additives, otherwise the emission control system could be damaged. Consult an expert repairer, we recommend an Authorised Mazda Repairer for details.*

Petrol blended with oxygenates such as alcohol or ether compounds are generally referred to as oxygenated fuels. The common petrol blend that can be used with your vehicle is ethanol blended at no more than 10 %. Petrol containing alcohol, such as ethanol or methanol, may be marketed under the name “Gasohol”.

Vehicle damage and drivability problems resulting from the use of the following may not be covered by the Mazda warranty.

- Gasohol containing more than 10 % ethanol.
- Petrol or gasohol containing methanol.
- Leaded fuel or leaded gasohol.

Fuel and Emission

▼ Fuel Requirements (Except Australia)

Vehicles with catalytic converters or oxygen sensors must use **ONLY UNLEADED FUEL**, which will reduce exhaust emissions and keep spark plug fouling to a minimum.

The vehicle will perform best with fuel listed in the table.

Fuel	Research Octane Number
Regular unleaded fuel	90 or above

Fuel with a lower rating will negatively affect the emission control system performance and could also cause engine knocking and serious engine damage.

CAUTION

➤ **USE ONLY UNLEADED FUEL.**

Leaded fuel is harmful to the catalytic converter and oxygen sensors and will lead to deterioration of the emission control system and or failures.

➤ *This vehicle can only use oxygenated fuels containing no more than 10 % ethanol by volume. Damage to the vehicle may occur when ethanol exceeds this recommendation, or if the petrol contains any methanol. Stop using gasohol of any kind if your vehicle engine is performing poorly.*

➤ *Never add fuel system additives, otherwise the emission control system could be damaged. Consult an expert repairer, we recommend an Authorised Mazda Repairer for details.*

▼ Emission Control System

This vehicle is equipped with an emission control system (the catalytic converter is part of this system) that enables the vehicle to comply with existing exhaust emissions requirements.

WARNING

Never park over or near anything flammable:

Parking over or near anything flammable, such as dry grass, is dangerous. Even with the engine turned off, the exhaust system remains very hot after normal use and could ignite anything flammable. A resulting fire could cause serious injury or death.

 **CAUTION**

Ignoring the following precautions could cause lead to accumulate on the catalyst inside the converter or cause the converter to get very hot. Either condition will damage the converter and cause poor performance.

- *USE ONLY UNLEADED FUEL.*
- *Do not drive your Mazda with any sign of engine malfunction.*
- *Do not coast with the ignition switched off.*
- *Do not descend steep grades in gear with the ignition switched off.*
- *Do not operate the engine at high idle for more than 2 minutes.*
- *Do not tamper with the emission control system. All inspections and adjustments must be made by a qualified technician.*
- *Do not push-start or pull-start this vehicle.*

▼ Engine Exhaust (Carbon monoxide) **WARNING*****Do not drive your vehicle if you smell exhaust gas inside the vehicle:***

Engine exhaust gas is dangerous. This gas contains carbon monoxide (CO), which is colourless, odourless, and poisonous. When inhaled, it can cause loss of consciousness and death. If you smell exhaust gas inside the vehicle, keep all windows fully open and contact an expert repairer, we recommend an Authorised Mazda Repairer immediately.

Do not run the engine when inside an enclosed area:

Running the engine inside an enclosed area, such as a garage, is dangerous. Exhaust gas, which contains poisonous carbon monoxide, could easily enter the cabin. Loss of consciousness or even death could occur.

Open the windows or adjust the heating or cooling system to draw fresh air when idling the engine:

Exhaust gas is dangerous. When the vehicle is stopped with the windows closed and the engine running for a long time even in an open area, exhaust gas, which contains poisonous carbon monoxide, could enter the cabin. Loss of consciousness or even death could occur.

Before Driving

Fuel and Emission

Clear snow from underneath and around your vehicle, particularly the tail pipe, before starting the engine:

Running the engine when a vehicle is stopped in deep snow is dangerous. The exhaust pipe could be blocked by the snow, allowing exhaust gas to enter the cabin. Because exhaust gas contains poisonous carbon monoxide, it could cause loss of consciousness or even death to occupants in the cabin.

Fuel-Filler Flap and Cap

▼ Fuel-Filler Flap and Cap

WARNING

When removing the fuel-filler cap, loosen the cap slightly and wait for any hissing to stop, then remove it:

Fuel spray is dangerous. Fuel can burn skin and eyes and cause illness if ingested. Fuel spray is released when there is pressure in the fuel tank and the fuel-filler cap is removed too quickly.

Before refuelling, stop the engine, and always keep sparks and flames away from the filler neck:

Fuel vapour is dangerous. It could be ignited by sparks or flames causing serious burns and injuries.

Additionally, use of the incorrect fuel-filler cap or not using a fuel-filler cap may result in a fuel leak, which could result in serious burns or death in an accident.

Do not continue refuelling after the fuel pump nozzle shuts off automatically:

Continuing to add fuel after the fuel pump nozzle has shut off automatically is dangerous because overfilling the fuel tank may cause fuel overflow or leakage. Fuel overflow and leakage could damage the vehicle and if the fuel ignites it could cause a fire and explosion resulting in serious injury or death.

CAUTION

- Always use only a designated Mazda fuel-filler cap or an approved equivalent, available at an expert repairer, we recommend an Authorised Mazda Repairer. The wrong cap can result in a serious malfunction of the fuel and emission control systems.
- When using an automatic car wash or a high water pressure car wash, lock the driver's door. Otherwise, the fuel-filler flap may open unexpectedly and could be damaged.

▼ Refuelling

Before refuelling, close all the doors, windows, and liftgate/boot lid, and switch the ignition OFF.

1. Unlock the driver's door.

NOTE

- When the driver's door is locked/unlocked, the fuel flap is also locked/unlocked at the same time.
- The time until the fuel flap is locked after locking the driver's door can be changed.
Refer to the Settings section in the MZD Connect Owner's Manual.
- However, if you change the time until the fuel flap is locked, locking of the fuel flap using the following functions is not applicable.
 - Auto lock/unlock function (page 3-15)
 - Auto re-lock function (page 3-5, 3-12)

Before Driving

Fuel and Emission

2. Press the location shown in the illustration and open the fuel flap.

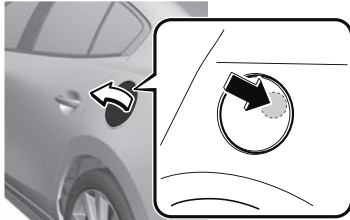

3. To remove the fuel-filler cap, turn it anticlockwise.
4. Attach the removed cap to the inner side of the fuel-filler flap.

Saloon

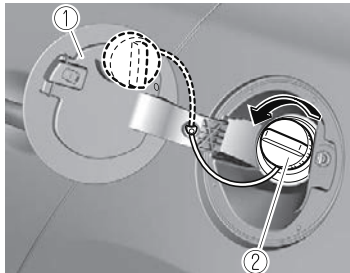

1. Fuel-filler flap
2. Fuel-filler cap

Hatchback

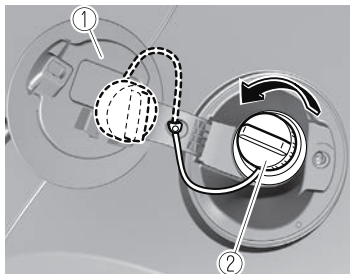

1. Fuel-filler flap
2. Fuel-filler cap

5. Insert the refuelling nozzle all the way and begin refuelling. Pull out the refuelling nozzle after the refuelling stops automatically.
6. To close the fuel-filler cap, turn it clockwise until a click is heard.
7. To close, press the fuel-filler flap until a click sound is heard.

Saloon

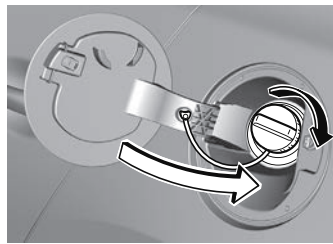

Hatchback

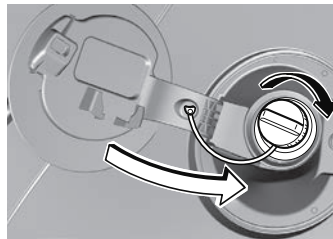

8. Make sure to lock all the doors when leaving the vehicle.

NOTE

Lock the doors after closing the fuel-filler flap.

If the fuel-filler flap is closed after locking the doors, the fuel-filler flap cannot be locked.

Mirrors

▼ Mirrors

Before driving, adjust the inside and outside mirrors.

▼ Outside Mirrors

! WARNING

Be sure to look over your shoulder before changing lanes:
Changing lanes without taking into account the actual distance of the vehicle in the convex mirror is dangerous. You could have a serious accident. What you see in the convex mirror is closer than it appears.

Mirror type

Flat type (driver's side)

Flat surface mirror.

Convex type (front passenger side)

The mirror has single curvature on its surface.

Power mirror adjustment

The ignition must be switched to ACC or ON position.

To adjust:

1. Press the select switch for the outside mirror to be adjusted to turn on the indicator light.

2. Press the adjustment switch to adjust the angle of the outside mirror.

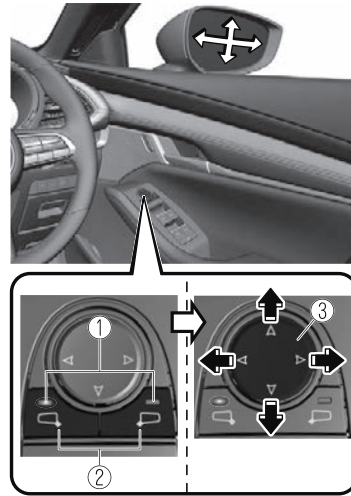

1. Indicator light
2. Select switch
3. Adjustment switch

After adjusting the angle of the outside mirror, press the select switch for the outside mirror to be adjusted to turn off the indicator light.

NOTE

(With driving position memory function)

The on-road outside mirror position can be programmed in conjunction with the driving position memory function. Refer to Driving Position Memory on page 2-11.

Power mirrors with reverse tilt down function*

The outside mirrors tilt downward to facilitate the view of the lower area on each side of the vehicle.

1. Switch the ignition ON.

*Some models. **3-27**

Mirrors

2. Press the select switch for the outside mirror to be tilted downward to turn on the indicator light of the select switch.
3. Shift the selector lever/shift lever to the R position to tilt the outer mirror on the side where the select button was pressed downward.

NOTE

When any of the following condition is met, the outer mirrors return to their normal positions.

- The ignition is switched to a position other than ON.
- The selector lever/shift lever is shifted to a position other than R.
- The select switch is pressed again.

Folding outside mirror



Always return the outside mirrors to the driving position before you start driving:

Driving with the outside mirrors folded in is dangerous. Your rear view will be restricted, and you could have an accident.

Manual folding outside mirror

Fold the outside mirror rearward until it is flush with the vehicle.



Power folding outside mirror



Do not touch a power folding outside mirror while it is moving:

Touching the power folding outside mirror when it is moving is dangerous. Your hand could be pinched and injured or the mirror could be damaged.

Use the switch to set the mirror to the on-road position:

Setting the power folding outside mirror to the on-road position by hand is dangerous. The mirror will not lock in position and will prevent effective rearview visibility.

Only operate the power folding outside mirror with the vehicle safely parked:

Operating the power folding outside mirror while the vehicle is moving is dangerous. Wind blast on the mirror will cause them to collapse and you will be unable to return it to the on-road position, preventing rearview visibility.

The ignition must be switched to ACC or ON position.

To fold the mirrors, press the outside mirror folding switch.

To return the mirrors to their on-road positions, press the switch again.

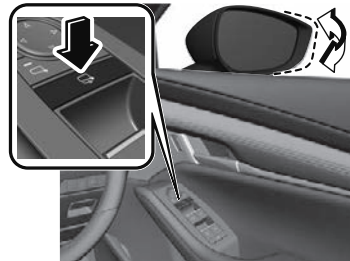

Automatic folding function

When the ignition is switched to OFF, the outside mirrors automatically fold in and out when the doors are locked and unlocked.

Also, when the ignition is switched ON or the engine is started, the outside mirrors fold out automatically.

NOTE

- *The outside mirrors may not fold in and out automatically under cold weather conditions.*
If the outside mirrors do not fold in and out automatically, remove any ice or snow, and then press the outside mirror folding switch to fold the outside mirrors in or out.
 - *The automatic folding function can be turned on or off.*
Refer to the Settings section in the MZD Connect Owner's Manual.
 - *In the following cases, the outside mirrors do not fold out automatically.*
Press the outside mirror folding switch to fold out the outside mirrors.
 - *Pressing the outside mirror folding switch to fold in the outside mirrors.*
**1*
 - *Disconnecting the battery terminals after the outside mirrors fold in automatically.*
- *1 When the automatic folding function is changed from off to on after folding in the outside mirrors, the outside mirrors fold out automatically.*

Engine-off outside mirror operation*

The outside mirrors can be operated for about 40 seconds after the ignition is switched from ON to off.

Driver's side auto-dimming outside mirror*

The movement of the auto-dimming outside mirror is interlocked with the auto-dimming rearview mirror in the interior to automatically reduce glare from rear on-coming vehicles.

Refer to Rearview Mirror on page 3-29.

NOTE

The front passenger-side outside mirror does not have the auto-dimming feature.

▼ Rearview Mirror

⚠ WARNING

Do not stack cargo or objects higher than the seatbacks:

Cargo stacked higher than the seatbacks is dangerous. It can block your view in the rearview mirror, which might cause you to hit another car when changing lanes.

Rearview mirror adjustment

Before driving, adjust the rearview mirror to centre on the scene through the rear window.

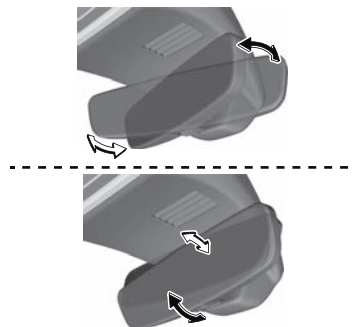

*Some models.

Mirrors

NOTE

For the manual antidazzle mirror, perform the adjustment with the antidazzle lever in the day position.

Reducing glare from headlights

Manual antidazzle mirror

Push the antidazzle lever forward for day driving. Pull it back to reduce glare of headlights from vehicles at the rear.

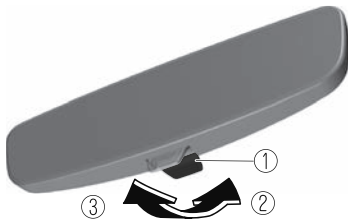

1. Antidazzle lever
2. Day
3. Night

Auto-dimming mirror

The auto-dimming mirror automatically reduces the glare of headlights from vehicles at the rear when the ignition is switched ON.

NOTE

- Do not use glass cleaner or suspend objects on or around the light sensor. Otherwise, light sensor sensitivity will be affected and may not operate normally.

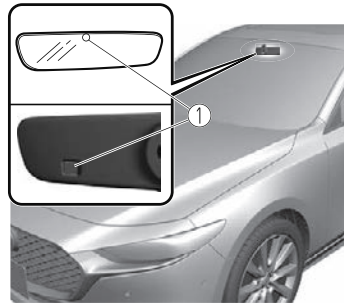

1. Light sensor

- The auto-dimming function is cancelled when the ignition is switched ON and the shift/selector lever is in the R position.

Power Windows

▼ Power Windows

The windows can be opened/closed by operating the power window switches.

WARNING

Make sure the opening is clear before closing a window:

Closing a power window is dangerous. A person's hands, head, or even neck could be caught by the window and result in serious injury or even death. This warning applies especially to children.

Never allow children to play with power window switches:

Power window switches that are not locked with the power window lock switch would allow children to operate power windows unintentionally, which could result in serious injury if a child's hands, head or neck becomes caught by the window.

Make sure nothing blocks the window just before it reaches the fully closed position or while fully holding up the power window switch:

Blocking the power window just before it reaches the fully closed position or while fully holding up the power window switch is dangerous.

In this case, the jam-safe function may not prevent the window from closing all the way. If fingers are caught, serious injuries could occur.

Do not let a child put a hand or head out of the window while driving the vehicle:

If the person's hand or head hits something outside the vehicle, or sudden braking is applied, it could result in serious injury or death.

NOTE

When driving with only 1 of the rear windows open, your ears might experience a resonating sound. However, this does not indicate a problem. The sound can be reduced by slightly opening a front window or by changing the size of the rear window opening.

Windows

▼ Opening/Closing Windows

The window opens while the switch is pressed and it closes while the switch is pulled up with the ignition switched ON. Do not open or close 3 or more windows at the same time.

The front passenger's side and rear windows can be opened/closed when the power window lock switch on the driver's door is in the unlock position. Keep this switch in the locked position while children are in the vehicle.

Master control switches

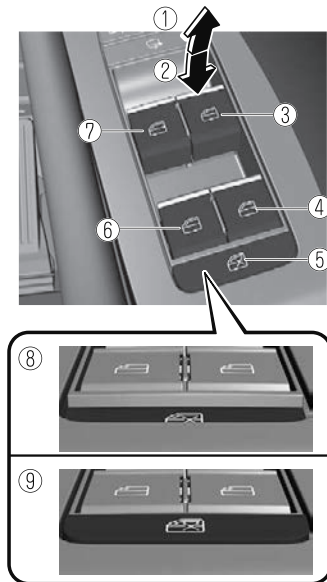

1. Close
2. Open
3. Driver's window
4. Right rear window
5. Power window lock switch
6. Left rear window
7. Front passenger's window

8. Locked position
9. Unlocked position

Front passenger's switch/Rear window switches

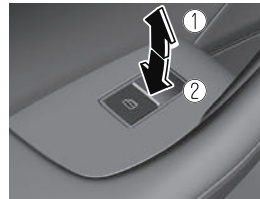

1. Close
2. Open

NOTE

- A power window may no longer open/close if you continue to press the switch for a long time. If the power window does not open/close, wait for a while and then operate the switch again.
- The passenger windows may be opened or closed using the master control switches on the driver's door.
- The power window can be operated for about 40 seconds after the ignition is switched from ON to ACC or off with all doors closed. If any door is opened, the power window will stop operating.

▼ Auto-opening/Closing

To fully open the window automatically, press the switch completely down, then release. The window will fully open automatically.

To fully close the window automatically, pull the switch completely up, then release. The window will fully close automatically.

To stop the window partway, pull or press the switch in the opposite direction and then release it.

NOTE

Power window system initialization procedure

If you operate the switch any number of times with the power window not fully closed, the window may no longer fully open/close automatically.

The power window auto function will only resume on a power window that has been reset.

1. Switch the ignition ON.
2. Make sure that the power window lock switch located on the driver's door is not depressed.
3. Press the switch and fully open the window.
4. Pull up the switch to fully close the window and continue holding the switch for about 2 seconds after the window fully closed.
5. Make sure that the power windows operate correctly using the door switches.

▼ Jam-safe Window

When the window is closing and a foreign object is detected between the window and the window frame, the window stops closing and automatically opens partway.

NOTE

· *The jam-safe function may operate under the following conditions:*

- *A strong impact is detected while the window is closing.*
- *The window is closing in very low temperatures.*

· **(A window cannot be closed)**

If the jam-safe function has operated and the window cannot be closed, check around the window frame for a foreign object.

If there is no foreign object around the window frame, forcibly close a window using the following procedure.

1. *After switching the ignition OFF, wait for 45 seconds or longer.*
2. *Switch the ignition ON.*
3. *Operate the switch in the direction to close the window until the jam-safe function operates 5 times.*
4. *Continue pulling up the switch to fully close the window.*

Windows

Sunroof*

▼ Sunroof

The sunroof can be opened or closed when operating the overhead tilt/slide switch at the front seats.

⚠ WARNING

Do not let passengers stand up or extend part of the body through the open sunroof while the vehicle is moving:

Extending the head, arms, or other parts of the body through the sunroof is dangerous. The head or arms could hit something while the vehicle is moving. This could cause serious injury or death.

Never allow children to play with the tilt/slide switch:

The tilt/slide switch would allow children to operate the sunroof unintentionally, which could result in serious injury if a child's hands, head or neck becomes caught by the sunroof.

Make sure the opening is clear before closing the sunroof:

A closing sunroof is dangerous. The hands, head, or even neck of a person, especially a child, could be caught in it as it closes, causing serious injury or even death.

Make sure nothing blocks the sunroof just before it reaches the fully closed position:

Blocking the sunroof just before it reaches the closed position is dangerous. In this case, the jam-safe function cannot prevent the sunroof from closing. If fingers are caught, serious injuries could occur.

⚠ CAUTION

- *Do not sit on or put heavy items on the area where the sunroof opens and closes. Otherwise, the sunroof could be damaged.*
- *Do not open or close the sunroof forcefully during freezing temperatures or snowfall. Otherwise, the sunroof could be damaged.*
- *The sunshade does not tilt. To avoid damaging the sunshade, do not push it up.*
- *Do not close the sunshade while the sunroof is opening. Trying to force the sunshade closed could damage it.*

▼ Tilt/Slide Operation

The sunroof can be opened or closed electrically only when the ignition is switched ON.

- Before leaving the vehicle or washing your Mazda, make sure the sunroof is completely closed so that water does not get inside the cabin area.
- After washing your Mazda or after it rains, wipe the water off the sunroof before operating it to avoid water penetration which could cause rust and water damage to your headliner.

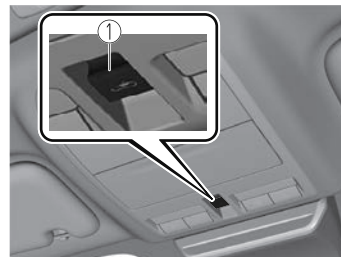

1. Tilt/Slide switch

Tilt Operation

The rear of the sunroof can be tilted open to provide more ventilation.

To fully tilt automatically, momentarily press the tilt/slide switch.

To fully close automatically, momentarily press the tilt/slide switch in the forward direction.

To stop tilting partway, press the tilt/slide switch.

When the sunroof is already slid open and you want to tilt it open, first close the sunroof and then do a tilt operation.

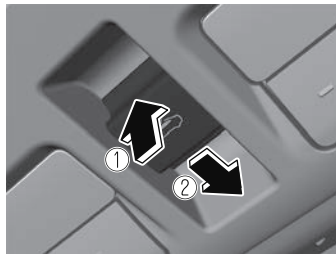

1. Tilt up
2. Close (Tilt down)

Slide Operation

To fully open automatically, momentarily press the tilt/slide switch in the backward direction.

To fully close automatically, momentarily press the tilt/slide switch in the forward direction.

To stop sliding partway, press the tilt/slide switch.

When the sunroof is already tilted open and you want to slide it open, first close the sunroof and then do a slide operation.

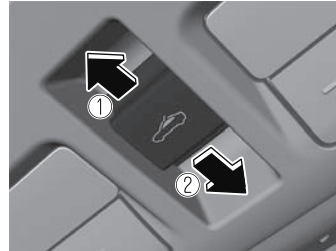

1. Open
2. Close

NOTE

If the sunroof does not operate normally, do the following procedure:

1. Switch the ignition ON.
2. Press the tilt switch, to partially tilt open the rear of the sunroof.
3. Repeat Step 2. The rear of the sunroof tilts open to the fully open position, then closes a little.

If the reset procedure is performed while the sunroof is in the slide position (partially open) it will close before the rear tilt opens.

▼ Jam-safe Sunroof

If a person's hands, head or an object blocks the sunroof while it is closing, the sunroof will stop and move in the open direction.

NOTE

- The jam-safe function may operate under the following conditions:
 - A strong impact is detected while the sunroof is closing automatically.

Before Driving

Windows

- *The sunroof is closing automatically during very low temperatures.*
- *In the event the jam-safe function activates and the sunroof cannot be closed automatically, press the tilt/slide switch and the sunroof will close.*
- *The jam-safe sunroof function does not operate until the system has been reset.*

▼ Sunshade

The sunshade can be opened and closed by hand.

The sunshade opens at the same time as the sunroof slides open, but it must be closed by hand.

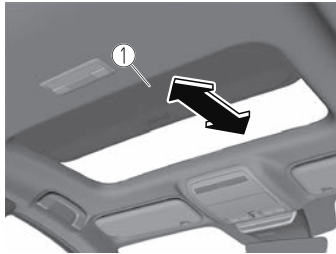

1. Sunshade

Modification and Add-On Equipment

▼ Modification and Add-On Equipment

Mazda cannot guarantee the immobilizer system's operation if the system has been modified or if any add-on equipment has been installed.

CAUTION

To avoid damage to the vehicle, do not modify the system or install any add-on equipment to the immobilizer system or the vehicle.

Immobilizer System

▼ Immobilizer System

The immobilizer system allows the engine to start only with a key the system recognises.

If someone attempts to start the engine with an unrecognised key, the engine will not start, thereby helping to prevent vehicle theft.

If you have a problem with the immobilizer system or the key, consult an Authorised Mazda Repairer.

CAUTION

- *Changes or modifications not expressly approved by the party responsible for compliance could void the user's authority to operate the equipment.*
- *To avoid damage to the key, do not:*
 - *Drop the key.*
 - *Get the key wet.*
 - *Expose the key to any kind of magnetic field.*
 - *Expose the key to high temperatures on places such as the instrument panel or bonnet, under direct sunlight.*
- *If the engine does not start with the correct key, and the security indicator light keeps illuminating or flashing, the system may have a malfunction. Consult an Authorised Mazda Repairer.*

Security System

NOTE

- The keys carry a unique electronic code. For this reason, and to assure your safety, obtaining a replacement key requires some waiting time. They are only available through an Authorised Mazda Repairer.
- Always keep a spare key in case one is lost. If a key is lost, consult an Authorised Mazda Repairer as soon as possible.
- If you lose a key, an Authorised Mazda Repairer will reset the electronic codes of your remaining keys and immobilizer system. Bring all the remaining keys to an Authorised Mazda Repairer to reset. Starting the vehicle with a key that has not been reset is not possible.

▼ Operation

NOTE

- The engine may not start and security indicator light may illuminate or flash if the key is placed in an area where it is difficult for the system to detect the signal, such as on the instrument panel or in the glove compartment. Move the key to a location within the signal range, switch the ignition off, and then restart the engine.
- Signals from a TV or radio station, or from a transceiver or mobile telephone could interfere with your immobilizer system. If you are using the proper key and the engine fails to start, check the security indicator light.

Arming

The system is armed when the ignition is switched from ON to off. The security indicator light in the instrument cluster flashes every 2 seconds until the system is disarmed.



Disarming

The system is disarmed when the ignition is switched ON with the correct programmed key. The security indicator light illuminates for about 3 seconds and then turns off.

If the engine does not start with the correct key, and the security indicator light remains illuminated or flashing, try the following:

Make sure the key is within the operational range for signal transmission. Switch the ignition off, and then restart the engine. If the engine does not start after 3 or more tries, contact an Authorised Mazda Repairer.

Running-In Period

▼ Running-In Period

No special running-in is necessary, but a few precautions in the first 1,000 km (600 miles) may add to the performance, economy, and life of the vehicle.

- Do not race the engine.
- Do not maintain one constant speed, either slow or fast, for a long period of time.
- Do not drive constantly at full-throttle or high engine rpm for extended periods of time.
- Avoid unnecessary hard stops.
- Avoid full-throttle starts.
- Do not tow a trailer.

Saving Fuel and Protection of the Environment

▼ Saving Fuel and Protection of the Environment

How you operate your Mazda determines how far it will travel on a tank of fuel. Use these suggestions to help save fuel and reduce CO₂.

- Avoid long warm-ups. Once the engine runs smoothly, begin driving.
- Avoid fast starts.
- Drive at lower speeds.
- Anticipate when to apply the brakes (avoid sudden braking).
- Follow the maintenance schedule and have an expert repairer, we recommend an Authorised Mazda Repairer perform inspections and servicing.
Refer to Australia and New Zealand on page 6-3.
- Use the air conditioner only when necessary.
- Slow down on rough roads.
- Keep the tyres properly inflated.
- Do not carry unnecessary weight.
- Do not rest your foot on the brake pedal while driving.
- Keep the wheels in correct alignment.
- Keep windows closed at high speeds.
- Slow down when driving in crosswinds and headwinds.

Driving Tips

WARNING

Never stop the engine when going down a hill:

Stopping the engine when going down a hill is dangerous. This causes the loss of power steering and power brake control, and may cause damage to the drivetrain. Any loss of steering or braking control could cause an accident.

Hazardous Driving

▼ Hazardous Driving

WARNING

Be extremely careful if it is necessary to downshift on slippery surfaces:

Downshifting into lower gear while driving on slippery surfaces is dangerous. The sudden change in tyre speed could cause the tyres to skid. This could lead to loss of vehicle control and an accident.

When driving on ice or in water, snow, mud, sand, or similar hazards:

- Be cautious and allow extra distance for braking.
- Avoid sudden braking and sudden manoeuvring.
- Do not pump the brakes. Continue to press down on the brake pedal. Refer to Antilock Brake System (ABS) on page 4-75.
- If you get stuck, select a lower gear and accelerate slowly. Do not spin the front wheels.
- For more traction in starting on slippery surfaces such as ice or packed snow, use sand, rock salt, chains, carpeting, or other nonslip material under the front wheels.

NOTE

Use snow chains only on the front wheels.

Floor Mat

▼ Floor Mat

We recommend the use of Genuine Mazda floor mats.

⚠ WARNING

Make sure the floor mats are secured with the grommets or the retainers to prevent them from bunching up under the foot pedals (Driver's side):

Using a floor mat that is not secured is dangerous as it will interfere with the accelerator and brake pedal operation (driver's side), which could result in an accident.

Only use a floor mat which conforms to the shape of the floor on the driver's side and make sure it is oriented correctly.

Secure the floor mat using the grommets or retainers.

There are various ways to secure floor mats depending on the type used, therefore secure the mat according to the type.

After installing the floor mat, make sure that it does not slide from side to side or back and forth, and that there is sufficient clearance with the accelerator and brake pedals on the driver's side.

After removing the floor mat for cleaning or some other reason, always securely reinstall it while paying attention to the precautions just mentioned.

Do not install two floor mats, one on top of the other, on the driver's side:

Installing two floor mats, one on top of the other, on the driver's side is dangerous as the retention pins can only keep one floor mat from sliding forward.

Loose floor mat(s) will interfere with the foot pedals and could result in an accident. If using an all-weather mat for winter use always remove the original floor mat.

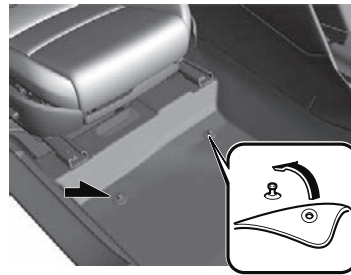

When setting a floor mat, position the floor mat so that its grommets or retainers are inserted over the pointed end of the retention posts.

Rocking the Vehicle

▼ Rocking the Vehicle



Do not spin the wheels at high speed, and do not allow anyone to stand behind a wheel when pushing the vehicle:

When the vehicle is stuck, spinning the wheels at high speed is dangerous. The spinning tyre could overheat and explode. This could cause serious injuries.



Too much rocking may cause engine overheating, transmission failure, and tyre damage.

If you must rock the vehicle to free it from snow, sand or mud, depress the accelerator slightly and slowly move the shift lever/selector lever from 1 (D) to R position.

Winter Driving

▼ Winter Driving

Carry emergency gear, including tyre chains, window scraper, flares, a small shovel, jumper leads, and a small bag of sand or salt.

Ask an expert repairer, we recommend an Authorised Mazda Repairer to check the following:

- Have the proper ratio of antifreeze in the radiator.
Refer to Engine Coolant on page 6-15.
- Inspect the battery and its leads. Cold reduces battery capacity.
- Use an engine oil appropriate for the lowest ambient temperatures that the vehicle will be driven in (page 6-13).
- Inspect the ignition system for damage and loose connections.
- Use washer fluid made with antifreeze—but do not use engine coolant antifreeze for washer fluid (page 6-17).

NOTE

- *Remove snow before driving. Snow left on the windscreen is dangerous as it could obstruct vision.*
- *Do not apply excessive force to a window scraper when removing ice or frozen snow on the mirror glass and windscreen.*
- *Never use warm or hot water for removing snow or ice from windows and mirrors as it could result in the glass cracking.*

· Drive slowly. Braking performance can be adversely affected if snow or ice adheres to the brake components. If this situation occurs, drive the vehicle slowly, releasing the accelerator pedal and lightly applying the brakes several times until the brake performance returns to normal.

▼ Snow Tyres

WARNING

Use only the same size and type tyres (snow, radial, or non-radial) on all 4 wheels:

Using tyres different in size or type is dangerous. Your vehicle's handling could be greatly affected and result in an accident.

CAUTION

Check local regulations before using studded tyres.

NOTE

The tyre pressure monitoring system may not function correctly when using tyres with steel wire reinforcement in the sidewalls (page 4-224).

Use snow tyres on all 4 wheels

Do not exceed the maximum permissible speed for your snow tyres or legal speed limits.

▼ Tyre Chains

Check local regulations before using tyre chains.

CAUTION

- Chains may affect handling.
- Do not go faster than 50 km/h (30 mph) or the chain manufacturer's recommended limit, whichever is lower.
- Drive carefully and avoid bumps, holes, and sharp turns.
- Avoid locked-wheel braking.
- Do not use chains on a temporary spare tyre; it may result in damage to the vehicle and to the tyre.
- Do not use chains on roads that are free of snow or ice. The tyres and chains could be damaged.
- Chains may scratch or chip aluminium wheels.

NOTE

· The tyre pressure monitoring system may not function correctly when using tyre chains.

Install the chains on the front tyres only. Do not use chains on the rear tyres. Please consult an expert repairer, we recommend an Authorised Mazda Repairer.

Installing the chains

1. If your vehicle is equipped with wheel covers remove them, otherwise the chain bands will scratch them.
2. Secure the chains on the front tyres as tightly as possible. Always follow the chain manufacturer's instructions.

Before Driving

Driving Tips

3. Retighten the chains after driving 1/2—1 km (1/4—1/2 mile).

Driving In Flooded Area

▼ Driving In Flooded Area

WARNING

Dry off brakes that have become wet by driving slowly, releasing the accelerator pedal and lightly applying the brakes several times until the brake performance returns to normal:

Driving with wet brakes is dangerous. Increased stopping distance or the vehicle pulling to one side when braking could result in a serious accident. Light braking will indicate whether the brakes have been affected.

CAUTION

Do not drive the vehicle on flooded roads as it could cause short circuiting of electrical/electronic parts, or engine damage or stalling from water absorption. If the vehicle has been immersed in water, consult an expert repairer, we recommend an Authorised Mazda Repairer.

Towing Caravans and Trailers

▼ Towing Caravans and Trailers

Your Mazda was designed and built primarily to carry passengers and cargo. If you tow a trailer, follow these instructions because driver and passenger safety depends on proper equipment and safe driving habits. Towing a trailer will affect handling, braking, durability, performance, and economy. Never overload vehicle or trailer. Consult an Authorised Mazda Dealer if you need further details.

CAUTION

➤ Towing a trailer during the first 1,000 km (600 miles) of your new Mazda is not recommended. If you do, you may damage the power train components.

NOTE

- When towing a trailer, do not use the following safety systems (If a Mazda genuine trailer hitch is used, these systems are automatically turned off):
 - Blind Spot Monitoring (BSM)
 - Rear Cross Traffic Alert (RCTA)
 - Smart Brake Support [Rear] (SBS-R)
 - Smart Brake Support [Rear Crossing] (SBS-RC)
 - Parking Sensor System (Rear)

▼ Load Limits

CAUTION

Be aware of the towing load weight differences when towing at high altitudes. For altitudes exceeding 1,000 m, always reduce the towing load by 10% for every 1,000 m increase in altitude from the total weight (gross vehicle weight and load limit). If the determined maximum total towing load weight is exceeded, the engine and other power train parts may be damaged.

The total weight of a trailer or other towed vehicle must not exceed the following:
Trailer with brakes 1,200 kg (2,645.5 lb)
Trailer without brakes 600 kg (1,322.7 lb)

The downward load on the tow ball must not exceed 80 kg (176.3 lb).

Towing

▼ Towing Instructions

Follow these instructions to make your towing as safe and efficient as possible.

- Use only a Mazda-approved tow bar.
- Never exceed recommended load limits and always refer to the identification plate affixed to the tow bar.
- Before towing, inflate all tyres to the maximum recommended pressures.
You'll find these specifications on the edge of the driver's door.
- When on a hill or towing with heavy loads, always use a lower gear. This helps maintain speed. It also prevents engine and transaxle overloading when going up hills and reduces the need for braking when going down hills.
- Always allow a greater stopping distance than normal to prevent excessive braking, and avoid sudden stops that could cause loss of control.
- Frequently inspect oil and fluid levels.
- Because of the extra stress on your Mazda from towing, more frequent maintenance than usual is necessary.
- Your Mazda's behaviour changes while towing. Get accustomed to these changes over a short and safe trial distance before starting a long trip.
- Headlights may need re-aiming after a trailer has been attached, especially if a load equalizing hitch is not used.
- Due to the additional stress on the engine cooling system when towing, the airflow to the radiator must not be restricted in any way.
- Make sure the towed vehicle complies with all local regulations, especially in regard to lighting, mirrors, and safety chains. The tow bar should not obscure the rear number plate.
- Whenever you remove the tow bar, seal all mounting holes in the underbody to prevent the entry of exhaust fumes, dust, and water.
- Avoid parking on an incline with a trailer. If this must be done, follow these instructions.

Parking on an Incline

1. Set the parking brake and the brakes.
2. Have someone block the wheels of the vehicle and trailer while you apply the brakes.
3. After the wheels are blocked, release the parking brake and the brakes slowly, allowing the blocks to bear the load.
4. Set the parking brake firmly.
5. If the vehicle has an automatic transmission, put the selector lever in the P position. If it has a manual transmission, place the gear shift in 1 or R.

Starting on an Incline

1. Start the engine (page 4-5).
2. Release the parking brake and slowly pull away a short distance from the wheel blocks.
3. Stop on the nearest level ground, set the parking brake, and pick up the wheel blocks.

3-46

4 When Driving

Information concerning safe driving and stopping.

Start/Stop Engine.....	4-4	Switches and Controls.....	4-50
Ignition Switch.....	4-4	Lighting Control.....	4-50
Starting the Engine.....	4-5	Turn and Lane-Change	
Turning the Engine Off.....	4-10	Signals.....	4-54
i-stop.....	4-11	Windscreen Wipers and	
Cylinder Deactivation*	4-18	Washer.....	4-56
		Rear Window Wiper and Washer*	4-59
		Rear Window Defogger.....	4-60
		Horn.....	4-61
		Hazard Warning Flasher.....	4-61
Instrument Cluster and Display	4-19		
Instrument Cluster and			
Display.....	4-19		
Instrument Cluster.....	4-19		
Active Driving Display.....	4-35		
Manual Transmission		Brake.....	4-63
Operation.....	4-37	Brake System.....	4-63
Manual Transmission Shift		AUTOHOLD.....	4-69
Pattern.....	4-37	Emergency Stop Signal	
		System.....	4-73
		Hill Launch Assist (HLA).....	4-74
Automatic Transmission.....	4-39	ABS/TCS/DSC.....	4-75
Automatic Transmission		Antilock Brake System	
Controls.....	4-39	(ABS).....	4-75
Shift-Lock System.....	4-40	Traction Control System	
Transmission Ranges.....	4-41	(TCS).....	4-76
Manual Shift Mode.....	4-42	Dynamic Stability Control	
Direct Mode*	4-48	(DSC).....	4-77
Driving Tips.....	4-49		
		Drive Selection.....	4-79
		Drive Selection*	4-79
		Power Steering.....	4-81
		Power Steering.....	4-81

*Some models. **4-1**

i-ACTIVSENSE.....	4-82
i-ACTIVSENSE.....	4-82
High Beam Control System (HBC)*	4-87
Adaptive LED Headlights (ALH)*	4-90
Lane Departure Warning System (LDWS).....	4-92
Blind Spot Monitoring (BSM).....	4-96
Traffic Sign Recognition System (TSR).....	4-101
Distance & Speed Alert (DSA).....	4-108
Driver Attention Alert (DAA).....	4-109
Driver Monitoring (DM)*	4-111
Front Cross Traffic Alert (FCTA)*	4-113
Rear Cross Traffic Alert (RCTA).....	4-116
Mazda Radar Cruise Control (MRCC) (Manual Transmission).....	4-120
Mazda Radar Cruise Control with Stop & Go function (MRCC with Stop & Go function) (Automatic Transmission).....	4-128
Cruising & Traffic Support (CTS)*	4-138
Lane-keep Assist System (LAS).....	4-154
Intelligent Speed Assistance (ISA).....	4-158

Smart Brake Support (SBS).....	4-164
Smart Brake Support [Rear] (SBS- R)*	4-166
Smart Brake Support [Rear Crossing] (SBS-RC)*	4-170
360° View Monitor*	4-175
Forward Sensing Camera (FSC).....	4-206
Front Radar Sensor.....	4-210
Front Side Radar Sensor*	4-213
Rear Side Radar Sensor.....	4-214
Rear/Rear corner/Rear Side Ultrasonic Sensor*	4-216
Front Camera/Side Cameras/Rear Camera*	4-216
Driver Monitoring Camera*	4-217
Cruise Control.....	4-219
Cruise Control.....	4-219
Tyre Pressure Monitoring System.....	4-223
Tyre Pressure Monitoring System.....	4-223
Rear View Monitor.....	4-227
Rear View Monitor*	4-227
Parking Sensor System.....	4-236
Parking Sensor System*	4-236

4-2 *Some models.

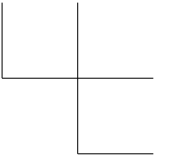
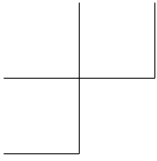

MEMO

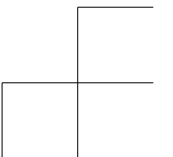
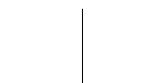
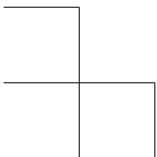
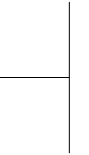
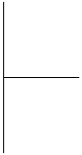

Start/Stop Engine

Ignition Switch

▼ Push Button Start Positions

The system operates only when the key is within operational range.

Each time the push button start is pressed, the ignition switches in the order of off, ACC, and ON. Pressing the push button start again from ON switches the ignition off.

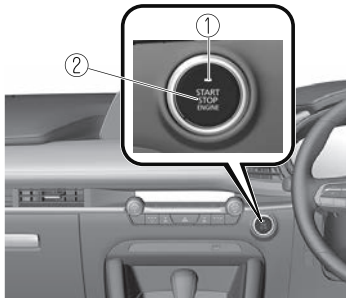

1. Indicator light
2. Push button start

NOTE

- The engine starts by pressing the push button start while depressing the clutch pedal (manual transmission) or the brake pedal (automatic transmission). To switch the ignition position, press the push button start without depressing the pedal.
- Do not leave the ignition switched ON while the engine is not running. Doing so could result in the battery going dead. If the ignition is left in ACC (For automatic transmission, the selector lever is in the P position, and the ignition is in ACC), the ignition switches off automatically after about 25 minutes.

Off

The power supply to electrical devices turns off and the indicator light (amber) also turns off.

In this position the steering wheel is locked.

WARNING

Before leaving the driver's seat, always switch the ignition off, set the parking brake, and make sure the selector lever is in P (automatic transmission) position or in 1st gear or R (manual transmission):

Leaving the driver's seat without switching the ignition off, setting the parking brake, and shifting the selector lever to P (automatic transmission) position or to 1st gear or R (manual transmission) is dangerous. Unexpected vehicle movement could occur which could result in an accident.

In addition, if your intention is to leave the vehicle for even a short period, it is important to switch the ignition off, as leaving it in another position will disable some of the vehicle's security systems and run the battery down.

NOTE

(Locked steering wheel)

If the push button start indicator light (green) is flashing, a message is displayed on the multi-information, and the beep sound is heard, this indicates that the steering wheel is not unlocked. To unlock the steering wheel, press the push button start while moving the steering wheel left and right.

ACC (Accessory)

Some electrical accessories will operate and the indicator light (amber) illuminates. In this position the steering wheel is unlocked.

NOTE

The keyless entry system does not function while the push button start has been pressed to ACC, and the doors will not lock/unlock even if they have been locked manually.

ON

This is the normal running position after the engine is started. The indicator light (amber) turns off. (The indicator light (amber) illuminates when the ignition is switched ON and the engine is not running.)

Some indicator lights/warning lights should be inspected before the engine is started.

Refer to Warning/Indicator Lights on page 4-30.

Refer to Indication/Indicator Lights on page 4-32.

NOTE

When the push button start is pressed to ON, the sound of the fuel pump motor operating near the fuel tank can be heard. This does not indicate an abnormality.

Starting the Engine

▼ Starting the Engine

WARNING

Radio waves from the key may affect medical devices such as pacemakers:

Before using the key near people who use medical devices, ask the medical device manufacturer or your physician if radio waves from the key will affect the device.

NOTE

- The key must be carried because the key carries an immobilizer chip that must communicate with the engine controls at short range.*
- The engine can be started when the push button start is pressed from off, ACC, or ON.*
- The push button start system functions (function which can start the engine by only carrying the key) can be deactivated to prevent any possible adverse effect on a user wearing a pacemaker or other medical device. If the system is deactivated, you will be unable to start the engine by carrying the key. Consult an expert repairer, we recommend an Authorised Mazda Repairer for details. If the push button start system functions have been deactivated, you can start the engine by following the procedure indicated when the key battery goes dead. Refer to Engine Start Function When Key Battery is Dead on page 4-8.*

Start/Stop Engine

· After starting a cold engine, the engine speed increases and a whining sound from the engine compartment can be heard.

This is for improved exhaust gas purification and does not indicate any parts defect.

1. Make sure you are carrying the key.
2. Occupants should fasten their seat belts.
3. Make sure the parking brake is on.
4. Continue to depress the brake pedal firmly until the engine has completely started.

5. **(Manual transmission)**

Continue to depress the clutch pedal firmly until the engine has completely started.

(Automatic transmission)

Put the vehicle in park (P). If you must restart the engine while the vehicle is moving, shift into neutral (N).

NOTE

· **(Manual transmission)**

The starter will not operate if the clutch pedal is not depressed sufficiently.

· **(Automatic transmission)**

The starter will not operate if the selector lever is not in P or N position and the brake pedal is not depressed sufficiently.

6. Make sure that the push button start indicator light (green) turns on.

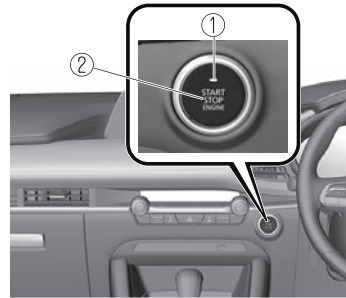

1. Indicator light
2. Push button start

NOTE

· If the push button start indicator light (green) flashes, make sure that the key is being carried.

· If the push button start indicator light (green) flashes with the key being carried, touch the key to the push button start and start the engine.

Refer to Engine Start Function When Key Battery is Dead on page 4-8.

CAUTION

If the KEY warning indication (red) is displayed, or the push button start indicator light (amber) flashes, this could indicate a problem with the engine starting system. This may prevent the engine from starting or from switching the ignition to ACC or ON (page 7-29). Have your vehicle inspected at an expert repairer, we recommend an Authorised Mazda Repairer as soon as possible.

Start/Stop Engine

NOTE

- Under the following conditions, the KEY warning indication (red) is displayed after the push button start is pressed. This informs the driver that the push button start will not switch to ACC, even if it is pressed from off (page 7-29).
 - The key battery is dead.
 - The key is out of operational range.
 - The key is placed in areas where it is difficult for the system to detect the signal (page 3-6).
 - A key from another manufacturer similar to the key is in the operational range.
- **(Forced engine starting method)**
If the KEY warning indication (red) is displayed, or the push button start indicator light (amber) flashes, this could indicate that the engine may not start using the usual starting method (page 7-29). Have your vehicle inspected at an expert repairer, we recommend an Authorised Mazda Repairer as soon as possible. If this occurs, the engine can be force-started. Press and hold the push button start until the engine starts. Other procedures necessary for starting the engine, such as having the key in the cabin, and depressing the clutch pedal (manual transmission) or the brake pedal (automatic transmission) are required.

- When the engine is force-started, the KEY warning indication (red) remains displayed and the push button start indicator light (amber) remains flashing.

- **(Automatic transmission)**

- When the selector lever is in the neutral (N) position, the push button start indicator light (green) does not turn on.

7. Press the push button start after the push button start indicator light (green) turns on.

NOTE

- After starting the engine, the push button start indicator light (amber) turns off and the ignition switches to the ON position.
 - After pressing the push button start and before the engine starts, the operation sound of the fuel pump motor from near the fuel tank can be heard, however, this does not indicate a malfunction.
8. After starting the engine, let it idle for about 10 seconds.

NOTE

- Whether the engine is cold or warm, it should be started without the use of the accelerator.
- If the engine does not start the first time, refer to Starting a Flooded Engine under Emergency Starting. If the engine still does not start, have your vehicle inspected by an Authorised Mazda Repairer (page 7-16).

Start/Stop Engine

· **(Manual transmission vehicle)**

If the engine has stopped due to stalling, it can be restarted by depressing the clutch pedal within 3 seconds of the engine stopping. The engine cannot be restarted even if the clutch pedal is depressed under the following conditions:

- The driver's door is open.
- The driver's seat belt is unfastened.
- The clutch pedal is not released completely after the engine stalled.
- The clutch pedal is depressed with the engine not stopped completely.

▼ Engine Start Function When Key Battery is Dead



When starting the engine by holding the transmitter over the push button start due to a dead key battery or a malfunctioning key, be careful not to allow the following, otherwise the signal from the key will not be received correctly and the engine may not start.

- Metal parts of other keys or metal objects touch the key.



- Spare keys or keys for other vehicles equipped with an immobilizer system touch or come near the key.



- Devices for electronic purchases, or security passage touch or come near the key.

If the engine cannot be started due to a dead key battery, the engine can be started using the following procedure:

1. Continue to depress the brake pedal firmly until the engine has completely started.
2. **(Manual transmission)**
Continue to depress the clutch pedal firmly until the engine has completely started.
(Automatic transmission)
Put the vehicle in park (P). If you must restart the engine while the vehicle is moving, shift into neutral (N).
3. Make sure that the push button start indication light (green) flashes.

Start/Stop Engine

- Align the centre area of the emblem on the transmitter with the centre area of the push button start while the push button start indicator light (green) flashes.

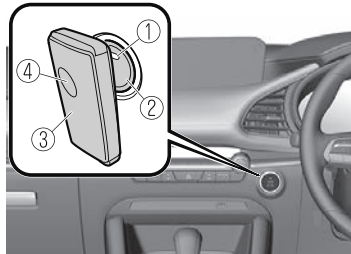

- Indicator light
 - Push button start
 - Transmitter
 - Emblem
- Make sure that the push button start indicator light (green) turns on.
 - Press the push button start to start the engine.

NOTE

- The engine cannot be started unless the clutch pedal is fully depressed (manual transmission) or the brake pedal is fully depressed (automatic transmission).
- If there is a malfunction with the push button start function, the push button start indicator light (amber) flashes. In this case, the engine may start, however, have the vehicle checked at an expert repairer, we recommend an Authorised Mazda Repairer as soon as possible.

- If the push button start indicator light (green) does not illuminate, perform the operation from the beginning again. If it does not illuminate, have the vehicle checked at an expert repairer, we recommend an Authorised Mazda Repairer.
- To switch the ignition position without starting the engine, perform the following operations after the push button start indicator light (green) turns on.
 - Release the clutch pedal (manual transmission) or brake pedal (automatic transmission).
 - Press the push button start to switch the ignition position. The ignition switches in the order of ACC, ON, and off each time the push button start is pressed. To switch the ignition position again, perform the operation from the beginning.

Start/Stop Engine

▼ Emergency Operation for Starting the Engine

If the KEY warning indication (red) is displayed, or the push button start indicator light (amber) flashes, this could indicate that the engine may not start using the usual starting method. Have your vehicle inspected at an expert repairer, we recommend an Authorised Mazda Repairer as soon as possible. If this occurs, the engine can be force-started. Press and hold the push button start until the engine starts. Other procedures necessary for starting the engine such as having the key in the cabin, and depressing the clutch pedal (manual transmission) or the brake pedal (automatic transmission) are required.

Turning the Engine Off

▼ Turning the Engine Off

WARNING

Do not stop the engine while the vehicle is moving:

Stopping the engine while the vehicle is moving for any reason other than in an emergency is dangerous. Stopping the engine while the vehicle is moving will result in reduced braking ability due to the loss of power braking, which could cause an accident and serious injury.

1. Stop the vehicle completely.
2. **(Manual transmission)**
Shift into neutral and set the parking brake.
(Automatic transmission)
Shift the selector lever to the P position and set the parking brake.
3. Press the push button start to turn off the engine. The ignition position is off.

CAUTION

➤ *When leaving the vehicle, make sure the push button start is off.*

NOTE

- *The cooling fan in the engine compartment could turn on for a few minutes after the ignition is switched from ON to OFF, whether or not the A/C is on or off, to cool the engine compartment quickly.*

- If the system detects that the remaining battery power of the key is low when the ignition is switched from ON to ACC or OFF, the following is indicated.
Replace with a new battery before the key becomes unusable.
Refer to Key Battery Replacement on page 6-25.
A message is indicated in the display of the instrument cluster.
Refer to KEY Warning Indication/Warning Light (Red) on page 7-29.
- **(Automatic transmission)**
If the engine is turned off while the selector lever is in a position other than P, the ignition switches to ACC.

▼ Emergency Engine Stop

Continuously pressing the push button start or quickly pressing it any number of times while the engine is running or the vehicle is being driven will turn the engine off immediately. The ignition switches to ACC.

i-stop

▼ i-stop

The i-stop function automatically stops the engine when the vehicle is stopped at a traffic light or stuck in traffic, and then restarts the engine automatically to resume driving. The system provides improved fuel economy, reduced exhaust gas emissions, and eliminates idling noise while the engine is stopped.

Engine idle stopping and restarting

NOTE

- After parking the vehicle, make sure that the ignition is switched OFF. There is the possibility of the vehicle moving if the vehicle is parked while i-stop is operating.
- The i-stop indicator light (green) turns on under the following conditions:
 - When engine idling is stopped.



- The i-stop indicator light (green) turns off when the engine is restarted.

Manual transmission

(AUTOHOLD operation turned off)

1. Stop the vehicle by depressing the brake pedal and then the clutch pedal.

Start/Stop Engine

2. While depressing the clutch pedal, shift the shift lever to the neutral position. Engine idling stops after the clutch pedal is released.
3. The engine restarts automatically when the clutch pedal is depressed.

(When the vehicle is stopped by the AUTOHOLD function)

1. Bring the vehicle to a complete stop by depressing the brake pedal first and then the clutch pedal.
2. While depressing the clutch pedal, shift the shift lever to neutral. After releasing your foot from the clutch pedal, engine idling stops and continues to be stopped even if the brake pedal is released.
3. The engine restarts automatically when the clutch pedal is depressed.

Automatic transmission

(AUTOHOLD operation turned off and When not using Mazda Radar Cruise Control with Stop & Go function (MRCC with Stop & Go function))

1. Engine idling stops when the brake pedal is depressed while the vehicle is driven (except for driving in the R or M position second gear fixed mode) and the vehicle is stopped.
2. The engine restarts automatically when the brake pedal is released with the selector lever in the D or M position (not in second gear fixed mode).

3. If the selector lever is in the N or P position, the engine does not restart when the brake pedal is released. The engine restarts when the brake pedal is depressed again or the selector lever is shifted to the D, M (not in second gear fixed mode) or the R position. (For the purposes of safety, always keep the brake pedal depressed when shifting the selector lever while engine idling is stopped.)

(When the vehicle is stopped by the Mazda Radar Cruise Control with Stop & Go function (MRCC with Stop & Go function) stop hold control)

1. When the vehicle is stopped by the Mazda Radar Cruise Control with Stop & Go function (MRCC with Stop & Go function), engine idling stops and continues to be stopped without depressing the brake pedal.
2. When the accelerator pedal is depressed or the RES switch is operated while the vehicle is kept stopped by the Mazda Radar Cruise Control with Stop & Go function (MRCC with Stop & Go function), the engine automatically restarts. The engine restarts automatically when the accelerator pedal is depressed with the selector lever in the D/M position (not in second gear fixed mode).

(When the vehicle is stopped by the AUTOHOLD function)

1. When the brake pedal is depressed while the vehicle is being driven (except for driving in the R or M position second gear fixed mode) and the vehicle is brought to a stop, the i-stop function will operate and it continues to operate even if the brake is released.

Start/Stop Engine

2. The engine restarts automatically when the accelerator pedal is depressed with the selector lever in the D/M position (not in second gear fixed mode).
3. If the selector lever is in the N or P position, the engine does not restart when the brake pedal is released. The engine restarts when the brake pedal is depressed again or the selector lever is shifted to the D, M (not in second gear fixed mode) or the R position. (For the purposes of safety, always keep the brake pedal depressed when shifting the selector lever while engine idling is stopped.)

Operation conditions

Under the following conditions, engine idling stops and the i-stop indicator light (green) turns on.

- The engine is warmed up.
- The engine has been started and the vehicle is driven for a certain period.
- The engine is started with the bonnet closed.
- The battery is in good condition.
- All doors, liftgate/boot lid, and bonnet are closed.
- The driver's seat belt is fastened.
- The air conditioner is not operating with the airflow mode in the  position.

· (Automatic air-conditioning)

- The temperature setting dial of the air conditioner is in a position other than maximum heating or maximum cooling (A/C ON) position.
- The vehicle's interior temperature and the set temperature for the air conditioner are nearly the same.
- The i-stop warning light (amber) is not turned on/flashing.
- The keyless entry & push button start system functions are normal.
- The brake vacuum is sufficiently high.

· (Manual transmission)

- The vehicle speed is 3 km/h (1.8 mph) or less.
- The shift lever is in the neutral position.
- The clutch pedal is not depressed.

· (Automatic transmission)

- The selector lever is in the D or M position (not in second gear fixed mode).
- The automatic transmission fluid has warmed up sufficiently.
- The automatic transmission fluid temperature is not abnormally high.
- The steering wheel is almost in the straight-ahead position (idling may not stop even with the steering wheel in the straight-ahead position if force is applied to the steering wheel. Release the force applied to the steering wheel to stop engine idling).
- The vehicle is stopped by depressing the brake pedal.
- The vehicle is not on a steep slope.
- The vehicle is not stopped suddenly.

Start/Stop Engine

NOTE

Under the following conditions, a period of time is required to stop engine idling

- The battery power is depleted for some reasons such as the vehicle has not been driven for a long period.
- The ambient temperature is high or low.
- After the battery terminals are disconnected for some reasons such as for battery replacement.

Engine does not restart

If the following operations are performed while the idling is stopped, the engine will not restart for safety reasons. In such cases, start the engine using the normal method.

- The bonnet is opened.
- **(Manual transmission)**
With the shift lever in a position other than neutral, the driver's seat belt is unfastened and the driver's door is opened.
- **(Automatic transmission)**
With the selector lever in the D or M (not in second gear fixed mode), the driver's seat belt is unfastened and the driver's door is opened.

Engine-stop period is short or time until next engine idle stop is long

- The ambient temperature is high or low.
- The battery power is depleted.
- Power consumption by the vehicle's electrical parts is high.

Engine restarts automatically while engine idling is stopped

Under the following conditions, the engine restarts automatically.

- The i-stop OFF switch is pressed until the beep sounds.

· The air conditioner is operated with the airflow mode in the  position.

· **(Automatic air-conditioning)**

- The temperature setting dial of the air conditioner is in the maximum heating or maximum cooling (A/C ON) position.
- The cabin temperature is largely different from the set temperature of the air conditioner.
- The brakes are released slightly on a slope and the vehicle begins to move.
- Two minutes have elapsed since the idling was stopped.
- The battery power is depleted.

· **(Manual transmission)**

With the shift lever in the neutral position, the driver's seat belt is unfastened, the driver's door is opened, or the bonnet is opened.

· **(Automatic transmission)**

- The accelerator pedal is depressed with the selector lever in the D or M (not in second gear fixed mode) position.
- The selector lever is shifted to the R position.
- The selector lever is shifted from N or P position to D or M (not in second gear fixed mode) position.
- The steering wheel is operated with the selector lever in the D or M (not in second gear fixed mode) position.
- The selector lever is in the M position and the second gear fixed mode is selected.

- With the selector lever in the P or N position, or the D/M range, the driver's seat belt is unfastened, the driver's door is opened, or the bonnet is opened.
- The steering wheel is operated.

Selector lever is operated while engine idling is stopped (automatic transmission)

If the selector lever is shifted from D or M (not in second gear fixed mode) position to N or P position while engine idling is stopped, the engine does not restart even when the brake pedal is released. The engine will restart if the brake pedal is depressed again or the selector lever is shifted to the D, M (not in second gear fixed mode), or R position. (For the purposes of safety, always keep the brake pedal depressed when shifting the selector lever while engine idling is stopped.)

If the selector lever is shifted from the D or M (not in second gear fixed mode) to the N or P position, and the driver's seat belt is unfastened or the driver's door is opened, the engine restarts.

Battery terminals are disconnected

Engine idling may not stop right after the battery terminals are disconnected. In addition, if the battery is replaced, the i-stop functions must be verified. Consult an expert repairer; we recommend an Authorised Mazda Repairer.

▼ **i-stop OFF Switch**

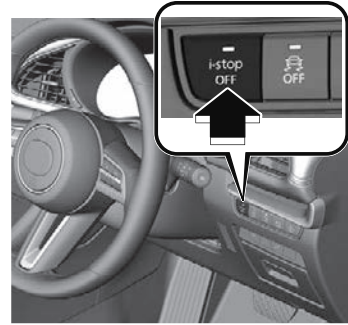

By pressing the switch until a beep sounds, the i-stop function is turned off. By pressing the switch again until the beep sounds, the i-stop function becomes operational.

NOTE

If the engine is stopped with the i-stop function cancelled, the i-stop function becomes operational when the engine is started the next time.

▼ **Vehicle Roll Prevention Function**

Vehicles with the i-stop function are equipped with a vehicle roll prevention function. This function prevents the vehicle from rolling, such as when releasing the brake pedal while on a slope under the following conditions:

- While engine idling is stopped (prevents the vehicle from rolling back)
- When the engine restarts after releasing the brake pedal (prevents the vehicle's sudden movement due to vehicle creep), sudden movement of the vehicle is prevented by controlling the brakes.

Start/Stop Engine

1. Release foot from brake pedal

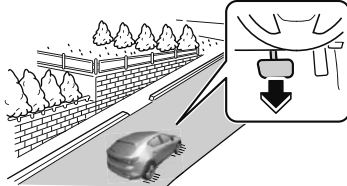

2. Vehicle brake force maintained

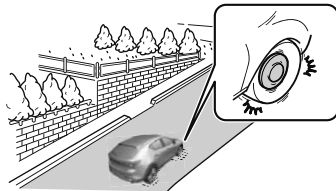

3. Engine restarted

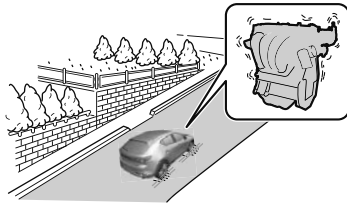

4. Acceleration

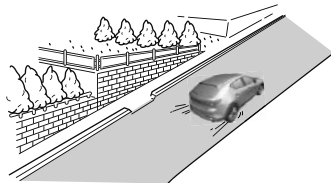

WARNING

Do not rely completely on the vehicle roll prevention function.

- The vehicle roll prevention function is a supplementary function which operates for a maximum of 2 seconds after releasing the brake pedal and accelerating the vehicle from an engine idling stop condition. Over reliance on the system may result in an unexpected accident if the vehicle were to suddenly accelerate. Before starting to drive the vehicle, always confirm the safety of the surroundings and operate the selector lever, brake pedal, and accelerator pedal appropriately. Note that the vehicle may move suddenly depending on the vehicle's load or if it is towing something.
- Note that the vehicle may move suddenly after the vehicle roll prevention function is released while the vehicle is under the following conditions:
 - The selector lever is in the N position.
 - If the selector lever is shifted to the N position and the brake pedal is released while the i-stop function is operating, the brake force is gradually released. To accelerate the vehicle, release the brake pedal after the engine restarts and shift the selector lever to a position other than the N position.

NOTE

- When the vehicle is stopped on a steep grade, the vehicle roll prevention function does not operate because engine idling is not stopped.
- The brake pedal response may change, sound may occur from the brakes, or the brake pedal could vibrate from the operation of the vehicle roll prevention function. However, this does not indicate a malfunction.

▼ **i-stop Warning Light (Amber)/i-stop Indicator Light (Green)**

i-stop

To ensure safe and comfortable use of the vehicle, the i-stop system constantly monitors the driver's operations, the vehicle's interior and exterior environment, and the operational status of the vehicle, and uses the i-stop warning light (amber) and i-stop indicator light (green) to inform the driver of various cautions and warnings.

NOTE

On vehicles equipped with the centre display, the i-stop operation status is displayed in the fuel efficiency monitor display.
Refer to the Fuel Efficiency Monitor section in the MZD Connect Owner's Manual.

i-stop warning light (amber)

When the light is turned on

- The light turns on when the ignition is switched ON and turns off when the engine is started.
- The light turns on if the following operations are performed while engine idling is stopped. In such cases, the engine does not restart automatically to ensure safety. Start the engine using the normal method.
 - The bonnet is opened.
 - The driver's seat belt is unfastened and the driver's door is opened.

NOTE

A problem in the system may be indicated under the following conditions. Have your vehicle inspected at an expert repairer; we recommend an Authorised Mazda Repairer.

- The light does not turn on when the ignition is switched ON.
- The light continues to remain on even though the i-stop OFF switch has been pressed while the engine is running.

Start/Stop Engine

When the light is flashing

The light continues to flash if the system has a malfunction. Have your vehicle inspected at an expert repairer, we recommend an Authorised Mazda Repairer.

i-stop indicator light (green)

When the light is turned on

- The light turns on while engine idling is stopped and turns off when the engine is restarted.

When the light is flashing

- **(Manual transmission)**
 - The light flashes when the shift lever is shifted to a position other than the neutral while engine idling is stopped to notify the driver that engine idling is stopped.
 - By depressing the clutch pedal, the engine restarts automatically and the light turns off.
 - The light flashes when the driver's door is opened while engine idling is stopped to notify the driver that engine idling is stopped. It turns off when the driver's door is closed.

Cylinder Deactivation*

▼ Cylinder Deactivation

The cylinder deactivation is a function designed to reduce fuel consumption and improve fuel economy by deactivating 2 out of the 4 cylinders while driving. The function constantly determines which is better for driving; 4 cylinders or 2 cylinders, regardless of the driver's operations, and it performs the switching automatically.

When the cylinder deactivation function does not operate

The cylinder deactivation function does not operate under the following conditions.

- The selector lever is in the P, N, or R position (automatic transmission), or 1st gear (manual transmission).
- The engine oil temperature or engine coolant temperature is low.
- After disconnecting the battery terminals for some reason, such as for battery replacement.

Instrument Cluster and Display

Instrument Cluster and Display

▼ Instrument Cluster and Display

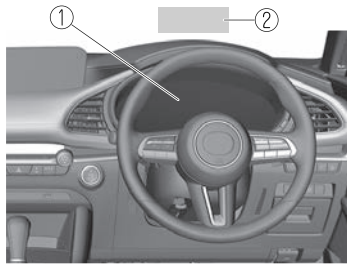

- ① Instrument Cluster..... page 4-19
- ② Active Driving Display.....page 4-35

Instrument Cluster

▼ Instrument Cluster

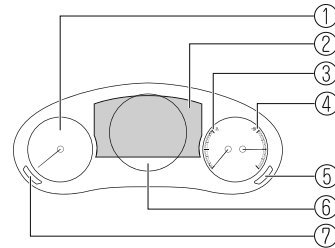

- ① Tachometer.....page 4-20
- ② Multi-information Display.....page 4-21
- ③ Engine Coolant Temperature Gauge.....page 4-24
- ④ Fuel Gauge.....page 4-24
- ⑤ Instrument Panel Illumination Switch..... page 4-25
- ⑥ Speedometer..... page 4-19
- ⑦ TRIP Switch.....page 4-23

▼ Speedometer

The speedometer indicates the speed of the vehicle.

When Driving

Instrument Cluster and Display

▼ Tachometer

The tachometer shows engine speed in thousands of revolutions per minute (rpm).



Do not run the engine with the tachometer needle in the RED ZONE.

This may cause severe engine damage.

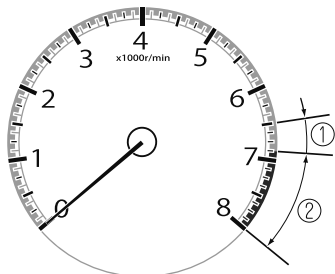

1. STRIPED ZONE*¹
2. RED ZONE*¹

*¹ The range varies depending on the type of gauge.

NOTE

When the tachometer needle enters the STRIPED ZONE, this indicates to the driver that the gears should be shifted before entering the RED ZONE.

Instrument Cluster and Display

▼ Multi-information Display

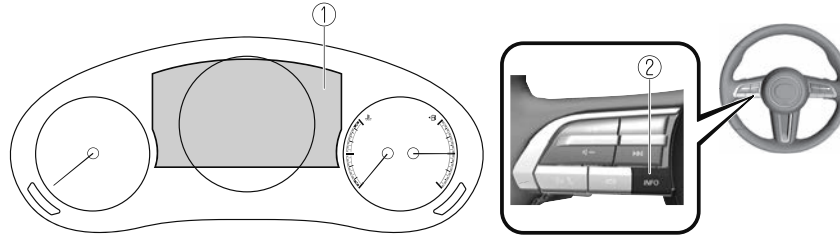

1. Multi-information Display
2. INFO switch

The multi-information display indicates the following information.

- Speedometer
- Odometer
- Trip meter
- Outside temperature
- Distance-to-empty
- Average fuel economy
- Current fuel economy
- i-ACTIVSENSE Display
- Vehicle Speed Alarm
- Door-Ajar/Boot lid-Ajar/Liftgate-Ajar Warning Indication*1
- Warning message

*1 Displayed when opening door/boot lid/liftgate.

When Driving

Instrument Cluster and Display

The screen content changes each time the INFO switch is pressed.

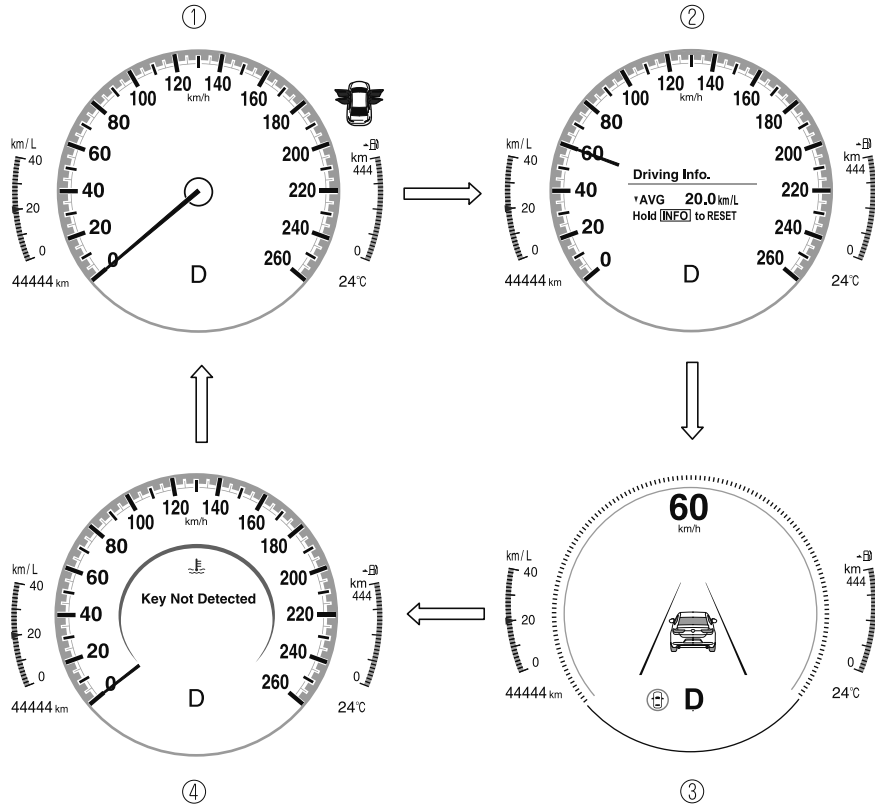

1. Basic display
2. Drive information display
3. i-ACTIVSENSE display
4. Warning message display*1

*1 Displayed only when a warning occurs.

The type of display for the fuel economy and the maximum driving distance can be changed.

Refer to the Settings section in the MZD Connect Owner's Manual.

Instrument Cluster and Display

▼ Odometer, Trip Meter and Trip Meter Selector

You can switch between the odometer and trip meter display using the TRIP switch.

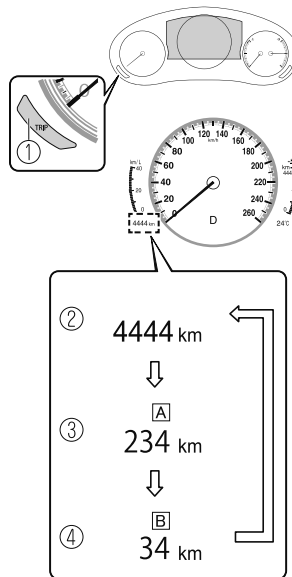

1. TRIP switch
2. Odometer display
3. Trip meter A display
4. Trip meter B display

Odometer

The odometer records the total distance the vehicle has been driven.

Trip meter

The driving distance for a specified interval is indicated. Two types (TRIP A, TRIP B) of interval distance and the average fuel economy for each can be measured.

For instance, trip meter A can record the distance from the point of origin, and trip meter B can record the distance from where the fuel tank is filled.

When trip meter A is selected, TRIP A will be displayed. When trip meter B is selected, TRIP B will be displayed.

The trip meter and average fuel economy can be reset by pressing the TRIP switch for 1.5 seconds or more while in each mode.

NOTE

- Only the trip meters record tenths of kilometres (miles).
- The trip record will be erased when:
 - The power supply is interrupted (blown fuse or the battery is disconnected).
 - The vehicle is driven over 9999.9 km (mile).

Instrument Cluster and Display

▼ Engine Coolant Temperature Gauge

Displays the engine coolant temperature. The blue gauge indicates that the engine coolant temperature is low, and the red gauge indicates that the engine coolant temperature is high and overheating.

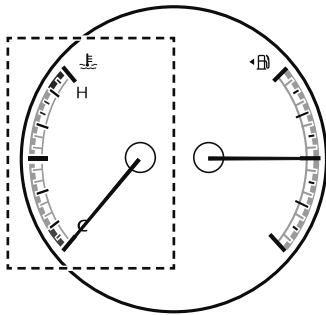

CAUTION

When the engine coolant temperature gauge needle is in the red range, the engine coolant temperature is extremely high. Drive slowly to reduce engine load. If the engine coolant temperature gauge needle is in the red range, there is the possibility of overheating. Park the vehicle in a safe place immediately and take appropriate measures.

Refer to *Overheating* on page 7-17.

NOTE

- If the engine or engine coolant temperature is high or low, the engine output may be restricted to protect the engine.
- During normal driving, the engine coolant temperature stabilizes at 100 °C (210 °F) or less, and the gauge indicates a range lower than 100 °C (210 °F).

4-24

▼ Fuel Gauge

The fuel gauge shows approximately how much fuel is remaining in the tank when the ignition is switched ON. We recommend keeping the tank over 1/4 full.

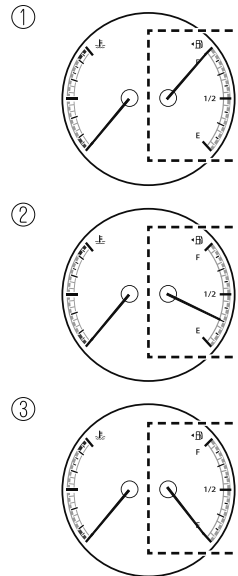

1. Full
2. 1/4 Full
3. Empty

If the low fuel warning light illuminates or the fuel level is very low, refuel as soon as possible.

Refer to *Low Fuel Warning Indication/Warning Light* on page 7-31.

NOTE

- After refuelling, it may require some time for the indicator to stabilize. In addition, the indicator may deviate while driving on a slope or curve since the fuel moves in the tank.

Instrument Cluster and Display

- The direction of the arrow (↖) indicates that the fuel-filler flap is on the left side of the vehicle.

▼ Instrument Panel Illumination

When the lights are turned on with the ignition switched ON, the brightness of the instrument panel illumination is dimmed. However, when the light sensor detects that the surrounding area is bright such as when the lights are turned on in the daytime, the instrument panel illumination does not dim.

NOTE

- When the ignition is switched ON in the early evening or at dusk, the instrument panel illumination is dimmed for several seconds until the light sensor detects the brightness of the surrounding area, however, the dimming may cancel after the brightness is detected.
- When the lights are turned on, the lights-on indicator light in the instrument cluster turns on.
Refer to *Headlights* on page 4-50.

The brightness of the instrument panel and instrument panel illuminations can be adjusted by pressing the instrument panel illumination switch while the instrument panel illumination is dimmed.

- The brightness decreases by pressing the - switch. If you press the - switch while the instrument cluster is at maximum dimness, a sound is activated to notify you that the current dimmer setting is at maximum dimness.

- The brightness increases by pressing the + switch.

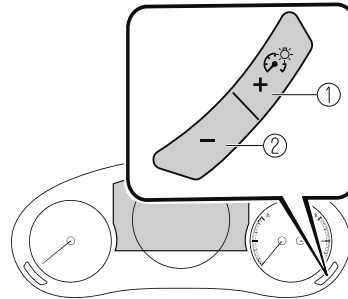

1. Bright
2. Dim

Function for cancelling illumination dimmer

The illumination dimmer can be cancelled by pressing the + switch while the instrument cluster is at maximum dimness and while the ignition is switched ON. If you press the + switch again while the illumination dimmer is cancelled, a sound is activated to notify you that it is cancelled. If the instrument cluster's visibility is reduced due to glare from surrounding brightness, cancel the illumination dimmer.

NOTE

- When the illumination dimmer is cancelled, the instrument cluster cannot be dimmed even if the lights are turned on.
- When the illumination dimmer is cancelled, the screen in the centre display switches to constant display of the daytime screen.

Instrument Cluster and Display

▼ Outside Temperature Display

When the ignition is switched ON, the outside temperature is displayed.

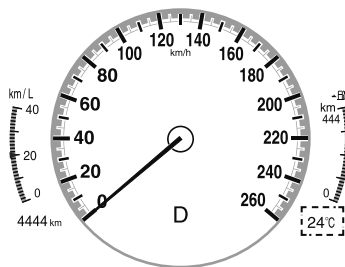

NOTE

- Under the following conditions, the outside temperature display may differ from the actual outside temperature depending on the surroundings and vehicle conditions:
 - Significantly cold or hot temperatures.
 - Sudden changes in outside temperature.
 - The vehicle is parked.
 - The vehicle is driven at low speeds.

▼ Distance-to-empty

This displays the approximate distance you can travel on the remaining fuel based on the fuel economy.

The distance-to-empty will be calculated and displayed every second.

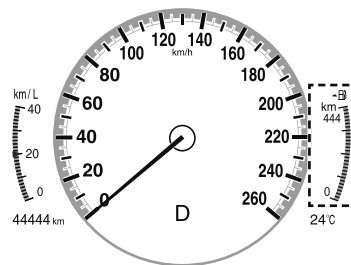

NOTE

- Even though the distance-to-empty display may indicate a sufficient amount of remaining driving distance before refuelling is required, refuel as soon as possible if the fuel level is very low or the low fuel warning light illuminates.
- The display will not change unless you add more than approximately 9 L (2.3 US gal, 1.9 Imp gal) of fuel.
- The distance-to-empty is the approximate remaining distance the vehicle can be driven until all the graduation marks in the fuel gauge indicating the remaining fuel supply disappear.
- If there is no past fuel economy information such as after first purchasing your vehicle or the information is deleted when the battery leads are disconnected, the actual distance-to empty/range may differ from the amount indicated.

Instrument Cluster and Display

▼ Average Fuel Economy

The average fuel economy is calculated every minute from the total travelled distance on the trip meter and the total fuel consumption, and the average fuel economy for either drive information display is displayed.

The average fuel economy for TRIP A is indicated by a red arrow in the instantaneous fuel economy display.

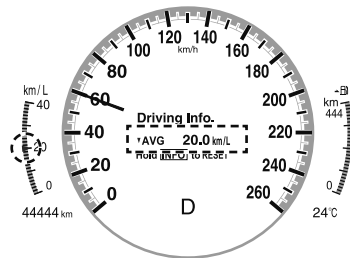

The average fuel economy and trip meters can be reset by pressing the INFO switch for 1.5 seconds or more while in each mode. After the data is cleared, the fuel consumption is recalculated and the --- km/L (--- mpg) for the 1 minute prior to it being displayed is indicated.

▼ Current Fuel Economy

This displays the current fuel economy by calculating the amount of fuel consumption and the distance travelled.

The average fuel economy for TRIP A is indicated by a red arrow.

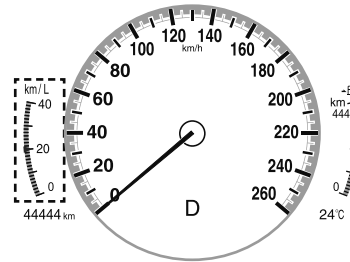

NOTE

Indicates the 0 position when the vehicle speed is about 5 km/h (3 mph) or slower.

▼ Vehicle Speed Alarm

In this mode, the current setting for the vehicle speed alarm is displayed. You can change the vehicle speed setting at which the warning is triggered.

NOTE

The vehicle speed alarm display is activated at the same time the beep sound is heard.

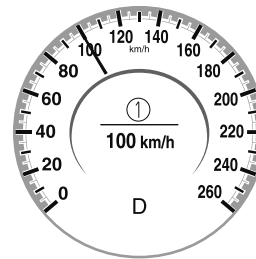

1. "Speed Alert 444 km/h" message is displayed

The vehicle speed alarm can be set using the centre display.

Instrument Cluster and Display

NOTE

Always set the vehicle speed according to the laws and regulations of the country/city in which the vehicle is driven. In addition, always verify the speed of the vehicle using the speedometer.

▼ i-ACTIVSENSE Display

Displays the system status.

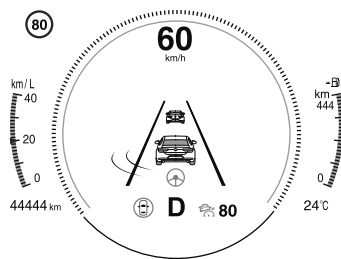

- Refer to Lane Departure Warning System (LDWS) on page 4-95.
- Refer to Blind Spot Monitoring (BSM) on page 4-99.
- Refer to Traffic Sign Recognition System (TSR) on page 4-104.
- Refer to Distance & Speed Alert (DSA) on page 4-109.
- Refer to Driver Attention Alert (DAA) on page 4-111.
- Refer to Driver Monitoring (DM) on page 4-112.
- Refer to Front Cross Traffic Alert (FCTA) on page 4-113.
- Refer to Mazda Radar Cruise Control (MRCC) on page 4-121.
- Refer to Mazda Radar Cruise Control with Stop & Go function (MRCC with Stop & Go function) on page 4-130.
- Refer to Cruising & Traffic Support (CTS) on page 4-142.
- Refer to Lane-keep Assist System (LAS) on page 4-157.

- Refer to Intelligent Speed Assistance (ISA) on page 4-158.
- Refer to Smart Brake Support (SBS) on page 4-165.
- Refer to Smart Brake Support [Rear] (SBS-R) on page 4-169.
- Refer to Smart Brake Support [Rear Crossing] (SBS-RC) on page 4-174.
- Refer to Cruise Control on page 4-219.

▼ Warning (Display Indication)

A message is displayed to notify the user of the system operation status and malfunctions or abnormalities.

If the warning light turns on/flashes simultaneously or a symbol is indicated in the display, check the information regarding the warning light or symbol. Refer to If a Warning Light Turns On or Flashes on page 7-23.

For messages not indicating a symbol, follow the instructions indicated in the multi-information display.

Refer to Message Indicated on

Multi-information Display on page 7-34.

Instrument Cluster and Display

▼ Warning/Indicator Lights

Instrument Cluster varies depending on model and specifications.

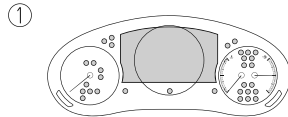











1. Instrument Cluster
2. Front Centre of Headliner

Warning lights will appear in any of the highlighted areas

Instrument Cluster and Display













▼ Warning Indication/Warning Lights

These lights turn on or flash to notify the user of the system operation status or a system malfunction.

Signal	Warning	Refer to
 BRAKE	Brake System Warning Indication/Warning Light* ¹	7-23
	ABS Warning Indication/Warning Light* ¹	Electronic Brake Force Distribution System Warning 7-24
		ABS warning 7-26
	Charging System Warning Indication/Warning Light* ¹	7-24
	Engine Oil Warning Indication/Warning Light* ¹	7-24
	High Engine Coolant Temperature Warning Indication	7-25
	Power Steering Malfunction Indication/Indicator Light* ¹	7-25
	Master Warning Indication	7-26
	Brake Control System Warning Indication/Warning Light* ¹	7-26
	Brake Override Warning Indication	7-27
	Check Engine Indication/Light* ¹	7-27
i-stop (Amber)	i-stop Warning Indication/Warning Light* ¹	7-27
AT	*Automatic Transmission Warning Indication/Warning Light* ¹	7-28
	Air Bag/Seat Belt Pretensioner System Warning Indication/Warning Light* ¹	7-28

4-30 *Some models.

Instrument Cluster and Display

Signal	Warning	Refer to
	Tyre Pressure Monitoring System (TPMS) Warning Indication/Warning Light* ¹	Flashing 7-29
		Turns on 7-32
 (Red)	KEY Warning Indication/Warning Light* ¹	7-29
 (Amber)	*High Beam Control System (HBC) Warning Indication/Warning Light* ¹	7-30
	Adaptive LED Headlights (ALH) Warning Indication/Warning Light ¹	7-30
	i-ACTIVSENSE Warning Indication/Warning Light* ¹	7-30
	Exterior Light Warning Indication/Warning Light* ¹	7-31
	Low Fuel Warning Indication/Warning Light	7-31
	Engine Oil Level Warning Indication/Warning Light* ¹	7-31
	Seat Belt Warning Indication/Warning Light (Front seat)	7-31
 (Red)	Seat Belt Warning Light (Rear seat)	7-32
	Door-Ajar Warning Indication	7-32
	*Boot lid-Ajar Warning Indication	7-32
	*Liftgate-Ajar Warning Indication	7-32
	Door-Ajar Warning Light	7-32









*¹ The light turns on when the ignition is switched on for an operation check, and turns off a few seconds later or when the engine is started. If the light does not turn on or remains turned on, have the vehicle inspected at an expert repairer, we recommend an Authorised Mazda Repairer.

*Some models. **4-31**

Instrument Cluster and Display









▼ Indication/Indicator Lights

These lights turn on or flash to notify the user of the system operation status or a system malfunction.

Signal	Indicator	Refer to
REAR  (Green)	Seat Belt Indicator Light (Rear seat)	2-28
PASSENGER AIRBAG 	Front Passenger Air Bag Deactivation Indicator Light	2-56
	Security Indicator Light	Immobilizer System 3-38
		Malfunction 7-30
 (Green)	KEY Indicator Light	4-5
 (Green)	i-stop Indicator Light	4-17
	Wrench Indication/Indicator Light*1	4-34
P	*Shift Position Indication	4-42
	Lights-On Indicator Light	4-50
	Headlight High-Beam Indicator Light	Headlight High-Low Beam 4-52
		Flashing the Headlights 4-52
	Direction Indicator/Hazard Warning Indicator Lights	Turn and Lane-Change Signals 4-54
		Hazard Warning Flasher 4-61

4-32 *Some models.

Instrument Cluster and Display

Signal	Indicator	Refer to
 PARK	Electric Parking Brake (EPB) Indication/Indicator Light*1*2	7-26
HOLD	AUTOHOLD Active Indicator Light*1	4-71
	*Mazda Radar Cruise Control with Stop & Go function (MRCC with Stop & Go function) indicator Light	4-137
	*Cruising & Traffic Support (CTS) indicator Light	4-153
	TCS/DSC Indication/Indicator Light*1	Traction Control System (TCS) 4-76
		Dynamic Stability Control (DSC) 4-77
		Turns on 7-28
 OFF	DSC OFF Indicator Light*1	4-78
SPORT	*Select Mode Indicator Light	4-80
 (White)	i-ACTIVSENSE Status Symbol (Warning/Risk Avoidance Support System)	4-84
 (Green)		
 (Amber)		
 (Green)	*High Beam Control System (HBC) Indicator Light	4-89
	*Adaptive LED Headlights (ALH) Indicator Light	4-91
 (White)	*Mazda Radar Cruise Control (MRCC) Standby Indication	4-124
	*Mazda Radar Cruise Control with Stop & Go function (MRCC with Stop & Go function) Standby Indication	4-133
	*Cruising & Traffic Support (CTS) Standby Indication	4-145
	*Mazda Radar Cruise Control (MRCC) Set Indication	4-124

*Some models. **4-33**

Instrument Cluster and Display

Signal	Indicator	Refer to
(Green)	*Mazda Radar Cruise Control with Stop & Go function (MRCC with Stop & Go function) Set Indication	4-133
	*Cruising & Traffic Support (CTS) Set Indication	4-145
	*Smart Brake Support (SBS) OFF Indicator Light* ¹	Smart Brake Support (SBS) 4-166
		Smart Brake Support [Rear] (SBS-R) 4-170
		Smart Brake Support [Rear Crossing] (SBS-RC) 4-174
LIM (White)	Intelligent Speed Assistance (ISA) Standby Indication	4-160
LIM (Green)	Intelligent Speed Assistance (ISA) Set Indication	4-160

*1 The light turns on when the ignition is switched on for an operation check, and turns off a few seconds later or when the engine is started. If the light does not turn on or remains turned on, have the vehicle inspected at an expert repairer, we recommend an Authorised Mazda Repairer.

*2 The light turns on continuously when the parking brake is applied.

▼ Wrench Indicator Light



The wrench indication/indicator light is displayed/turns on under the following conditions.

- When the preset maintenance period has arrived.
Refer to the Information section in the MZD Connect Owner's Manual.
- When the engine oil replacement period has arrived.

NOTE

- The wrench indication/indicator light may display/turn on earlier than the preset period depending on vehicle usage conditions.
- Whenever the engine oil is replaced, a reset of the vehicle engine control unit is necessary.
Refer to the Information section in the MZD Connect Owner's Manual.

4-34 *Some models.

Active Driving Display

▼ Active Driving Display

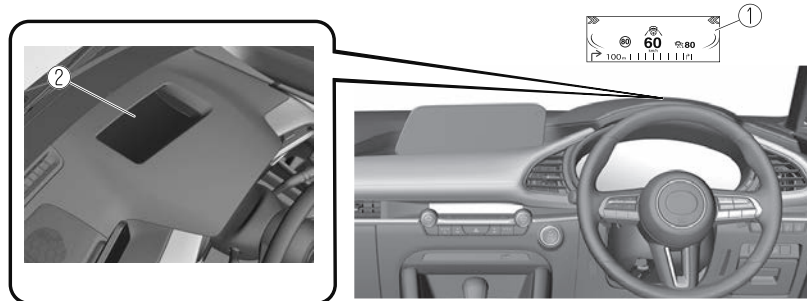

1. Display
2. Dust-proof sheet

! WARNING

Always adjust the display brightness and position with the vehicle stopped:
Adjusting the display brightness and position while driving the vehicle is dangerous as doing so could distract your attention from the road ahead and lead to an accident.

! CAUTION

- Do not place beverages near the active driving display. If water or other liquids are splashed on the active driving display, it could cause damage.
- Do not place objects above the active driving display or apply stickers to the dust-proof sheet as they will cause interference.

NOTE

- Wearing polarized sunglasses will reduce the visibility of the active driving display due to the characteristics of the display.
- If the battery has been removed and re-installed or the battery voltage is low, the adjusted position may deviate.
- The display may be difficult to view or temporarily affected by weather conditions such as rain, snow, light, and temperature.
- If the audio system is removed, the active driving display cannot be operated.

Instrument Cluster and Display

The active driving display indicates the following information:

- Blind Spot Monitoring (BSM) Operation Conditions and Warnings
Refer to Blind Spot Monitoring (BSM) on page 4-96.
- Traffic Sign Recognition System (TSR) traffic signs and Warnings
Refer to Traffic Sign Recognition System (TSR) on page 4-101.
- Front Cross Traffic Alert (FCTA) Operation Conditions and Warnings
Refer to Front Cross Traffic Alert (FCTA) on page 4-113.
- Mazda Radar Cruise Control (MRCC) Operation Conditions and Warnings
Refer to Mazda Radar Cruise Control (MRCC) on page 4-120.
- Mazda Radar Cruise Control with Stop & Go function (MRCC with Stop & Go function)
Operation Conditions and Warnings
Refer to Mazda Radar Cruise Control with Stop & Go function (MRCC with Stop & Go function) on page 4-128.
- Cruising & Traffic Support (CTS) Operation Conditions and Warnings
Refer to Cruising & Traffic Support (CTS) on page 4-138.
- Intelligent Speed Assistance (ISA) Operation Conditions and Warnings
Refer to Intelligent Speed Assistance (ISA) on page 4-158.
- Smart Brake Support (SBS) Operation Conditions and Warnings
Refer to Smart Brake Support (SBS) on page 4-164.
- Smart Brake Support [Rear] (SBS-R) Operation Conditions and Warnings
Refer to Smart Brake Support [Rear] (SBS-R) on page 4-166.
- Smart Brake Support [Rear Crossing] (SBS-RC) Operation Conditions and Warnings
Refer to Smart Brake Support [Rear Crossing] (SBS-RC) on page 4-170.
- Cruise Control Operation Conditions
Refer to Cruise Control on page 4-219.
- Navigation Guidance (vehicles with navigation system)
- Intersection Name (vehicles with navigation system)
- Street name (vehicles with navigation system)
- Lane Guidance (vehicles with navigation system)
- Speed limit indicator (vehicles with navigation system)
- Vehicle Speed

The active driving display settings can be changed or adjusted.
Refer to the Settings section in the MZD Connect Owner's Manual.

NOTE

- *The desired driving position (display position, brightness level, display information) can be called up after programming the position.
Refer to Driving Position Memory on page 2-11.*
- *The street name may not be displayed depending on the market and region.*

4-36

Manual Transmission Operation

Manual Transmission Shift Pattern

▼ Manual Transmission Shift Pattern

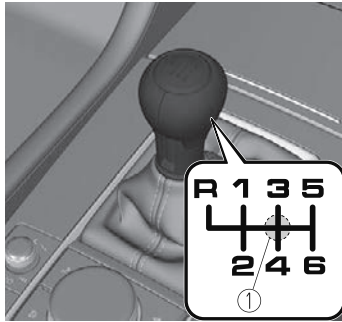

1. Neutral position

The shift pattern of the transmission is conventional, as shown.

Depress the clutch pedal all the way down while shifting; then release it slowly.

Your vehicle is equipped with a device to prevent shifting to R (reverse) by mistake. Push the shift lever downward and shift to R.

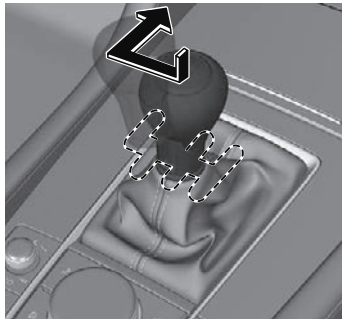

⚠ WARNING

Do not use sudden engine braking on slippery road surfaces or at high speeds: Shifting down while driving on wet, snowy, or frozen roads, or while driving at high speeds causes sudden engine braking, which is dangerous. The sudden change in tyre speed could cause the tyres to skid. This could lead to loss of vehicle control and an accident.

Always leave the shift lever in 1 or R position and set the parking brake when leaving the vehicle unattended: Otherwise the vehicle could move and cause an accident.

⚠ CAUTION

- Keep your foot off the clutch pedal except when shifting gears. Also, do not use the clutch to hold the vehicle on an upgrade. Riding the clutch will cause needless clutch wear and damage.
- Do not apply any excessive lateral force to the shift lever when changing from 5th to 4th gear. This could lead to the accidental selection of 2nd gear, which could result in damage to the transmission.
- Make sure the vehicle comes to a complete stop before shifting to R. Shifting to R while the vehicle is still moving may damage the transmission.

NOTE

- If shifting to R is difficult, shift back into neutral, release the clutch pedal, and try again.

Manual Transmission Operation

· If the engine has stopped due to stalling, it can be restarted by depressing the clutch pedal within 3 seconds of the engine stopping.

The engine cannot be restarted even if the clutch pedal is depressed under the following conditions:

- The driver's door is open.
- The driver's seat belt is unfastened.
- The clutch pedal is not released completely after the engine stalled.
- The clutch pedal is depressed with the engine not stopped completely.

▼ Gear Shift Indicator (GSI)

The GSI supports you to obtain optimum fuel economy and smooth driving. It displays the selected gear position in the instrument cluster as well as notifies the driver to change to the most suitable gear position corresponding to the actual driving condition.

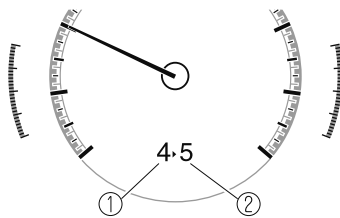

1. Selected gear position
2. Suitable gear position

Indication	Condition
Numeral	The selected gear position is displayed.
▶ and numeral	Shift up or down to the indicated gear position is recommended.

⚠ CAUTION

Do not rely solely on the shift-up/ shift-down recommendations by indications. The actual driving situation might require shift operations different from indication. To avoid the risk of accidents, the road and traffic conditions have to be judged correctly by the driver before shifting.

NOTE

The GSI turns off when the following operations are performed.

- The vehicle is stopped.
- The vehicle is put in neutral.
- The vehicle is driven in reverse.
- The clutch is not fully engaged when accelerating from a stop.
- The clutch pedal remains depressed for 2 seconds or longer while driving.

Automatic Transmission

Automatic Transmission Controls

▼ Automatic Transmission Controls

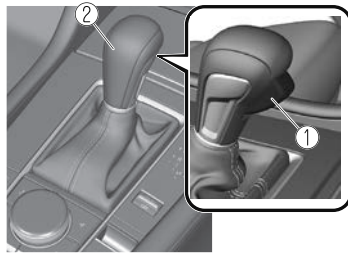

1. Lock-release button
2. Selector lever

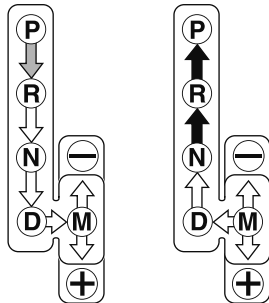

Indication	Various Lockouts
	Indicates that you must depress the brake pedal and hold in the lock-release button to shift (The ignition must be switched ON).
	Indicates the selector lever can be shifted freely into any position.
	Indicates that you must hold in the lock-release button to shift.

NOTE

The Sport AT has an option that is not included in the traditional automatic transmission that gives the driver the option of selecting each gear instead of leaving it to the transmission to shift gears. Even if you intend to use the automatic transmission functions as a traditional automatic, you should also be aware that you can inadvertently shift into manual shift mode and an inappropriate gear may be retained as the vehicle speed increases. If you notice the engine speed going higher or hear the engine racing, confirm you have not accidentally slipped into manual shift mode (page 4-42).

Automatic Transmission

Shift-Lock System

▼ Shift-Lock System

The shift-lock system prevents shifting out of P unless the brake pedal is depressed.

To shift from P:

1. Depress and hold the brake pedal.
2. Start the engine.
3. Press and hold the lock-release button.
4. Move the selector lever.

NOTE

- When the ignition is switched to ACC or the ignition is switched off, the selector lever cannot be shifted from P position.
- The ignition cannot be switched to OFF if the selector lever is not in P position.

▼ Shift-Lock Override

If the selector lever will not move from P position using the proper shift procedure, continue to hold down the brake pedal.

1. Remove the shift-lock override cover using a cloth-wrapped flat head screwdriver.
2. Insert a flat screwdriver and push it down.

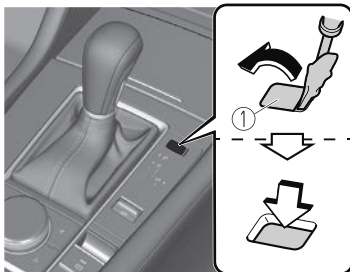

1. Cover

3. Press and hold the lock-release button.

4-40

4. Move the selector lever.

Take the vehicle to an expert repairer, we recommend an Authorised Mazda Repairer to have the system checked.

Automatic Transmission

Transmission Ranges

▼ Transmission Ranges

- The shift position indication in the instrument cluster illuminates. Refer to Shift Position Indication on page 4-42.
- Shift the selector lever to the P or N position to start the engine.

P (Park)

P locks the transmission and prevents the front wheels from rotating.

WARNING

Always set the selector lever to P position and set the parking brake:

Only setting the selector lever to the P position without using the parking brake to hold the vehicle is dangerous. If P fails to hold, the vehicle could move and cause an accident.

CAUTION

- *Shifting into P, N or R while the vehicle is moving can damage your transmission.*
- *Shifting into a driving gear or reverse when the engine is running faster than idle can damage the transmission.*

R (Reverse)

In position R, the vehicle moves only backward. You must be at a complete stop before shifting to or from R, except under rare circumstances as explained in Rocking the Vehicle (page 3-42).

N (Neutral)

In N, the wheels and transmission are not locked. The vehicle will roll freely even on the slightest incline unless the parking brake or brakes are on.

WARNING

If the engine is running faster than idle, do not shift from N or P into a driving gear:

It's dangerous to shift from N or P into a driving gear when the engine is running faster than idle. If this is done, the vehicle could move suddenly, causing an accident or serious injury.

Do not shift into N when driving the vehicle:

Shifting into N while driving is dangerous. Engine braking cannot be applied when decelerating which could lead to an accident or serious injury.

CAUTION

Do not shift into N when driving the vehicle. Doing so can cause transmission damage.

NOTE

Apply the parking brake or depress the brake pedal before moving the selector lever from N position to prevent the vehicle from moving unexpectedly.

D (Drive)

D is the normal driving position. From a stop, the transmission will automatically shift through a 6-gear sequence.

Automatic Transmission

M (Manual)

M is the manual shift mode position. Gears can be shifted up or down by operating the selector lever.

Refer to Manual Shift Mode on page 4-42.

▼ Shift Position Indication

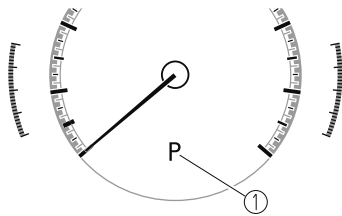

1. Shift position indication

The selector position is indicated when the ignition is switched ON.

Gear position indication

In manual shift mode, the “M” of the shift position indication illuminates and the numeral for the selected gear is displayed.

▼ Active Adaptive Shift (AAS)

Active Adaptive Shift (AAS) automatically controls the transmission shift points to best suit the road conditions and driver input. This improves driving feel. The transmission may switch to AAS mode when driving up and down slopes, cornering, driving at high elevations, or depressing the accelerator pedal quickly while the selector lever is in the D position. Depending on the road and driving conditions/vehicle operations, gear shifting could be delayed or not occur, however, this does not indicate a problem because the AAS mode will maintain the optimum gear position.

4-42

Manual Shift Mode

▼ Manual Shift Mode

The manual shift mode gives you the feel of driving a manual transmission vehicle by allowing you to operate the selector lever manually. This allows you to control engine rpm and torque to the drive wheels much like a manual transmission when more control is desired.

To change to manual shift mode, shift the lever from D to M.

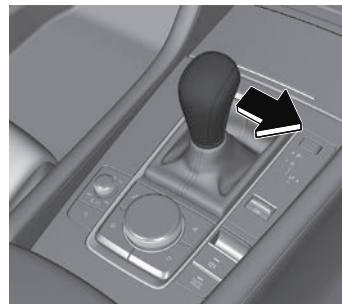

NOTE

- Changing to manual shift mode while driving will not damage the transmission.
- If you change to manual shift mode when the vehicle is stopped, the gear will shift to M1.
- If you change to manual shift mode without depressing the accelerator pedal when driving in D range, 5th gear/6th gear, the gear will shift to M4/M5.

To return to automatic shift mode, shift the lever from M to D.

Automatic Transmission

▼ Indicators

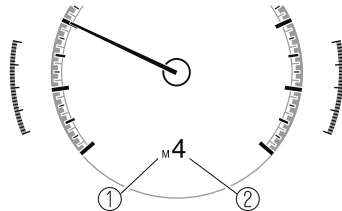

1. Manual shift mode indication
2. Gear position indication

Manual shift mode indication

In manual shift mode, the “M” of the shift position indication in the instrument panel illuminates.

Gear position indication

The numeral for the selected gear illuminates.

NOTE

- If the gears cannot be shifted down when driving at higher speeds, the gear position indication will flash twice to signal that the gears cannot be shifted down (to protect the transmission).
- If the automatic transmission fluid (ATF) temperature becomes too high, there is the possibility that the transmission will switch to automatic shift mode, cancelling manual shift mode and turning off the gear position indication illumination. This is a normal function to protect the AT. After the ATF temperature has decreased, the gear position indication illumination turns back on and driving in manual shift mode is restored.

▼ Manually Shifting Up

You can shift gears up by operating the selector lever or the steering shift switches*.

M1 → M2 → M3 → M4 → M5 → M6

Using selector lever

To shift up to a higher gear, tap the selector lever back + once.

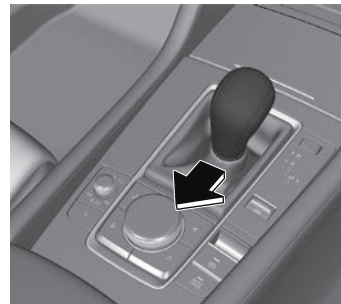

Using steering shift switch*

To shift up to a higher gear with the steering shift switches, pull the UP switch (+/OFF) toward you once with your fingers.

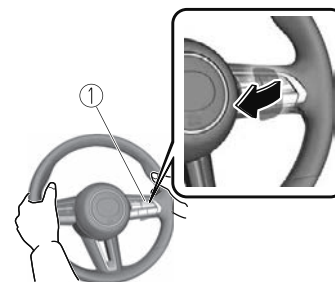

1. UP switch (+/OFF)

*Some models.

Automatic Transmission

WARNING

Keep your hands on the steering wheel rim when using fingers on the steering shift switches:

Putting your hands inside the rim of the steering wheel when using the steering shift switches is dangerous. If the driver's air bag were to deploy in a collision, your hands could be impacted causing injury.

NOTE

- When driving slowly, the gears may not shift up.
- Do not drive the vehicle with the tachometer needle in the RED ZONE while in manual shift mode. In addition, manual shift mode switches to automatic shift mode while the accelerator pedal is completely depressed.
- This function is cancelled while the DSC is turned off. However, if the vehicle is continuously driven at a high rpm, the gears may automatically shift up to protect the engine.
- The steering shift switch can be used temporarily even if the selector lever is in the D position while driving. In addition, it returns to automatic shift mode when the UP switch (+/OFF) is pulled rearward for a sufficient amount of time.

▼ **Manually Shifting Down**

You can shift gears down by operating the selector lever or the steering shift switches*.

M6 → M5 → M4 → M3 → M2 → M1

Using selector lever

To shift down to a lower gear, tap the selector lever forward – once.

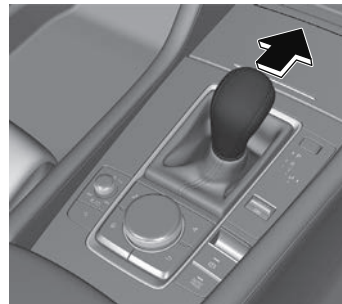

Using steering shift switch*

To shift down to a lower gear with the steering shift switches, pull the DOWN switch (–) toward you once with your fingers.

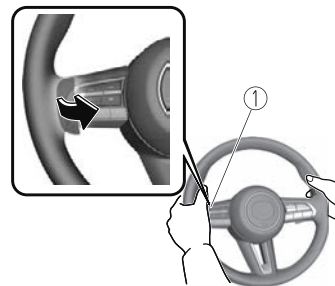

1. DOWN switch (–)

⚠ WARNING**Do not use engine braking on slippery road surfaces or at high speeds:**

Shifting down while driving on wet, snowy, or frozen roads, or while driving at high speeds causes sudden engine braking, which is dangerous. The sudden change in tyre speed could cause the tyres to skid. This could lead to loss of vehicle control and an accident.

Keep your hands on the steering wheel rim when using fingers on the steering shift switches:

Putting your hands inside the rim of the steering wheel when using the steering shift switches is dangerous. If the driver's air bag were to deploy in a collision, your hands could be impacted causing injury.

NOTE

- When driving at high speeds, the gear may not shift down.
- During deceleration, the gear may automatically shift down depending on vehicle speed.
- When depressing the accelerator fully, the transmission will shift to a lower gear, depending on vehicle speed. However, the gears do not kickdown while the DSC is turned off.

▼ Second Gear Fixed Mode

When the selector lever is moved back + while the vehicle speed is about 10 km/h (6.2 mph) or less, the transmission is set in the second gear fixed mode. The gear is fixed in second while in this mode for easier acceleration from a stop and driving on slippery roads such as snow-covered roads.

If the selector lever is moved back + or forward – while in the second gear fixed mode, the mode will be cancelled.

When Driving

Automatic Transmission

▼ Shift Gear (Shifting) Speed Limit

For each gear position while in the manual mode, the speed limit is set as follows: When the selector lever is operated within the range of the speed limit, the gear is shifted.

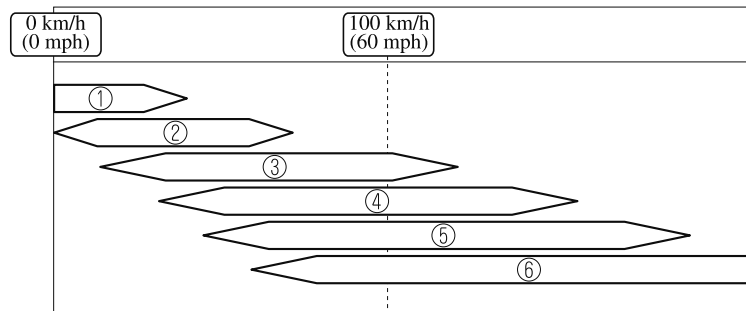

1. 1st
2. 2nd
3. 3rd
4. 4th
5. 5th
6. 6th

Shift up

The gear does not shift up while the vehicle speed is lower than the speed limit.

Shift down

The gear does not shift down while the vehicle speed exceeds the speed limit. If the vehicle speed exceeds the speed limit and the gear does not shift down, the gear position indication flashes 2 times to notify the driver that the gear cannot be shifted.

Kickdown

When the accelerator pedal is depressed fully while driving, the gear shifts down. However, the gears do not kickdown while the DSC is turned off.

NOTE

The gear also shifts down using kickdown while in the second gear fixed mode.

Auto-shift down

The gear shifts down automatically depending on the vehicle speed during deceleration.

Automatic Transmission

NOTE

If the vehicle comes to a stop while in the second gear fixed mode, the gear remains in second.

Automatic Transmission

Direct Mode*

▼ Direct Mode

Direct mode can be used for temporarily switching gears by operating the steering shift switch while the vehicle is being driven with the selector lever in the D position.

While in direct mode, the D and M indication illuminate and the gear position in use is illuminated.

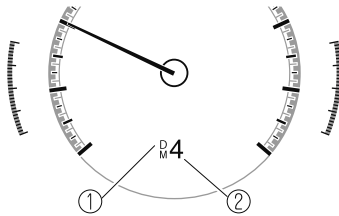

1. Direct mode indication
2. Gear position indication

Direct mode is cancelled (released) under the following conditions.

- The UP switch (+/OFF) is pulled rearward for a certain amount of time or longer.
- The vehicle is driven for a certain amount of time or longer (time differs depending on the driving conditions while operating).
- The vehicle is stopped or moving at a slow speed.

NOTE

Shifting up and down while in direct mode may not be possible depending on the vehicle speed. In addition, because direct mode is cancelled (released) depending on the rate of acceleration or if the accelerator is fully depressed, use of the manual shift mode is recommended if you need to drive the vehicle in a particular gear for long periods.

Automatic Transmission

Driving Tips

▼ Driving Tips

WARNING

Do not let the vehicle move in a direction opposite to the direction selected by the selector lever:

Do not let the vehicle move backward with the selector lever in a forward position, or do not let the vehicle move forward with the selector lever in the reverse position. Otherwise, the engine may stop, causing the loss of the power brake and power steering functions, and make it difficult to control the vehicle which could result in an accident.

Passing

For extra power when passing another vehicle or climbing steep grades, depress the accelerator fully. The transmission will shift to a lower gear, depending on vehicle speed.

NOTE

· The accelerator pedal may initially feel heavy as it is being depressed, then feel lighter as it is depressed further. This change in pedal force aids the engine control system in determining how much the accelerator pedal has been depressed for performing kickdown, and functions to control whether or not kickdown should be performed.

· While the selector lever is in the M position and the DSC is turned off, manual shift mode does not switch to automatic shift mode even if the accelerator pedal is completely depressed. Operate the selector lever.

Climbing steep grades from a stop

To climb a steep grade from a stopped position:

1. Depress the brake pedal.
2. Shift to D or M1, depending on the load weight and grade steepness.
3. Release the brake pedal while gradually accelerating.

Descending steep grades

When descending a steep grade, shift to lower gears, depending on load weight and grade steepness. Descend slowly, using the brakes only occasionally to prevent them from overheating.

Switches and Controls

Lighting Control

▼ Headlights

Turn the headlight switch to turn the headlights and other exterior lights on or off. When the lights are turned on, the lights-on indicator light in the instrument cluster turns on.



NOTE

To prevent discharging the battery, do not leave the lights on while the engine is off unless safety requires them.



Switch Position	OFF* ₁	AUTO		☰☽☻		☰☽
		Surround-ings are bright* ₂	Surround-ings are dark* ₃	Surround-ings are bright* ₂	Surround-ings are dark* ₃	
Headlights	Off	Off	On	Off	On* ₄ * ₅	On
Running lights	Off	On* ₆	Off	On* ₇	Off	Off
Tail lights Position lights Number plate lights	Off	Off	On	On	On	On





*₁ When the light switch is switched to OFF while the vehicle is stopped, the lights turn off. The light switch returns automatically to the **AUTO** position and the headlights change to AUTO operation when you start driving the vehicle.

*₂ The level of brightness around the vehicle is of a sufficient level.

*₃ The level of brightness around the vehicle is of an insufficient level.

*₄ The running lights can be disabled using the personalisation features (page 4-54). If the running lights are disabled, the headlights turn off directly after starting the engine. The headlights turn on when you begin driving the vehicle.

Switches and Controls

- *5 When the light switch is switched from the **OFF**, **AUTO**, or  position to the  position while the vehicle is stopped, the headlights turn off. When starting to drive the vehicle, the headlights turn on again.
- *6 When the light switch is switched to a different position from the **AUTO** position while the vehicle is stopped, the running lights turn off. When starting to drive the vehicle, the running lights turn on again.
- *7 If one of the following operations is done from the  position while the vehicle is stopped, the running lights turn off.
 - Switch the light switch to the **OFF** position.
 - Switch the light switch to the **AUTO** position, and then to the  position again.
 - Switch the light switch to the  position.

When starting to drive the vehicle, the running lights turn on again.

Auto-light control

When the headlight switch is in the **AUTO** position and the ignition is switched ON, the light sensor senses the surrounding lightness or darkness and automatically turns the headlights and other exterior lights on or off.

CAUTION

- Do not shade the light sensor by adhering a sticker or a label on the windscreen. Otherwise the light sensor will not operate correctly.



- The light sensor also works as a rain sensor for the auto-wiper control. Keep hands and scrapers clear of the windscreen when the wiper lever is in the **AUTO** position and the ignition is switched ON as fingers could be pinched or the wipers and wiper blades could be damaged when the wipers activate automatically. If you are going to clean the windscreen, be sure the wipers are turned off completely when it is particularly tempting to leave the engine running. This is particularly important when clearing ice and snow.

Switches and Controls

NOTE

- The headlights and other exterior lights may not turn off immediately even if the surrounding area becomes well-lit because the light sensor determines that it is night time if the surrounding area is continuously dark for several minutes such as inside long tunnels, traffic jams inside tunnels, or in indoor parking lots.
- The sensitivity of the auto-light control may be changed.
Refer to the Settings section in the MZD Connect Owner's Manual.

▼ Headlight High-Low Beam

The headlights switch between high and low beams by moving the lever forward or backward.

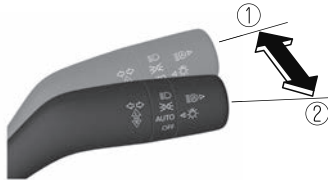

1. High beam
2. Low beam

When the headlight high-beams are on, the headlight high-beam indicator light is turned on.



▼ Flashing the Headlights

The headlights can be flashed with the ignition switched to ON.
To flash the headlights, pull the lever fully towards you (the headlight switch does not need to be on).



1. OFF
2. Headlight flashing

The headlight high-beam indicator light in the instrument cluster illuminates simultaneously. The lever will return to the normal position when released.



Switches and Controls

▼ Coming Home Light

The coming home light turns on the headlights (low beams) when the lever is operated.

To turn on the lights

When the lever is pulled with the ignition switched to ACC or OFF, the low beam headlights turn on.

The headlights turn off after a certain period of time has elapsed after the doors are closed.



NOTE

- The time until the headlights turn off after all of the doors are closed can be changed.
Refer to the Settings section in the MZD Connect Owner's Manual.
- If no operations are done for 3 minutes after the lever is pulled, the headlights turn off.
- The headlights turn off if the lever is pulled again while the headlights are illuminated.

▼ Leaving Home Light



The leaving home light turns on the lights when the transmitter unlock button is pressed while away from the vehicle.

The following lights turn on when the leaving home light is operated.

Low beams, Position lights, Tail lights, Number plate lights.

To turn on the lights

When the ignition switch and the headlight switch are in the following conditions, the headlights will illuminate when the transmitter unlock button is pressed and the vehicle receives the transmitter signal. The headlights turn off after a certain period of time has elapsed (30 seconds).

- Ignition switch: off
- Headlight switch: **AUTO**, , or 

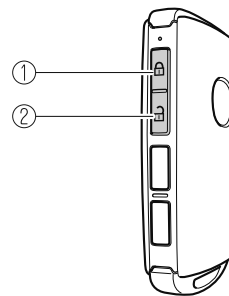

1. Lock button
2. Unlock button

NOTE

- Operation of the leaving home light can be turned on or off.
Refer to the Settings section in the MZD Connect Owner's Manual.
- When the transmitter lock button is pressed and the vehicle receives the transmitter signal, the headlights turn off.
- When the headlight switch is turned to the **OFF** position, the headlights turn off.

Switches and Controls

▼ Headlight Levelling

The number of passengers and weight of cargo in the luggage compartment change the angle of the headlights.

The angle of the headlights will be automatically adjusted when turning on the headlights.

A system malfunction or operation conditions are indicated by a warning. Refer to Exterior Light Warning Indication/Warning Light on page 7-31.

▼ Running Lights

The running lights turn on automatically.

NOTE

The running lights can be deactivated. Refer to the Settings section in the MZD Connect Owner's Manual.

Turn and Lane-Change Signals

▼ Turn and Lane-Change Signals

The ignition must be switched ON to use the turn and lane-change signals.

▼ Direction Indicators

Move the signal lever down (for a right turn) or up (for a left turn) to the stop position. The signal will self-cancel after the turn is completed.

If the indicator light continues to flash after a turn, manually return the lever to its original position.

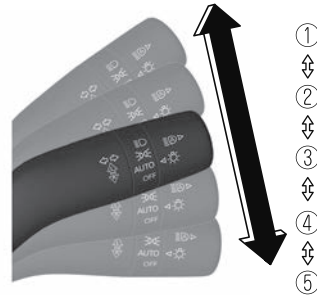

1. Left turn
2. Left lane change
3. OFF
4. Right lane change
5. Right turn

Switches and Controls

The direction indicators in the instrument cluster flash according to the operation of the direction indicator lever to show which signal is working.



NOTE

- *There may be a problem with the direction indicator lights if they do not flash but remain turned on, or they flash abnormally. Have your vehicle inspected by an expert repairer, we recommend an Authorised Mazda Repairer.*
- *A personalised function is available to change the turn indicator sound volume. Refer to the Settings section in the MZD Connect Owner's Manual.*

▼ Lane-Change Signals

Move the lever halfway toward the direction of the lane change—until the indicator flashes—and hold it there. It will return to the off position when released.

▼ Three-Flash Turn Signal

After releasing the direction indicator lever from the halfway point, the direction indicator flashes 3 times. The operation can be cancelled by moving the lever in the direction opposite to which it was operated.

NOTE

The three-flash turn signal function can be switched to on/off using the personalisation function. Refer to the Settings section in the MZD Connect Owner's Manual.

Switches and Controls

Windscreen Wipers and Washer

▼ Windscreen Wipers and Washer

The ignition must be switched ON to use the wipers.

! WARNING

Use only windscreen washer fluid or plain water in the reservoir:

Using radiator antifreeze as washer fluid is dangerous. If sprayed on the windscreen, it will dirty the windscreen, affect your visibility, and could result in an accident.

Only use windscreen washer fluid mixed with anti-freeze protection in freezing weather conditions:

Using windscreen washer fluid without anti-freeze protection in freezing weather conditions is dangerous as it could freeze on the windscreen and block your vision which could cause an accident. In addition, make sure the windscreen is sufficiently warmed using the defroster before spraying the washer fluid.

NOTE

If the windscreen wipers are operated under cold weather conditions or during snowfall, they could stop due to accumulated snow on the windscreen. If the windscreen wipers stop due to accumulated snow on the windscreen, park the vehicle in a safe place, turn the wiper switch off, and then remove the accumulated snow. If the wiper switch is turned to another position other than OFF, the wipers will operate. If the wipers do not operate even though the wiper switch is turned to a position other than OFF, consult an expert repairer; we recommend an Authorised Mazda Repairer as soon as possible.

▼ Windscreen Wipers

Turn the wipers on by pressing the lever up or down.

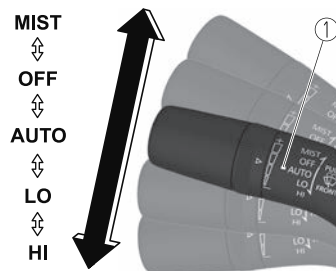

1. Indicator light

Switch Position	Wiper operation
MIST	Operation while pulling up lever
OFF	Stop
AUTO*1	Auto control
LO	Low speed

Switches and Controls

Switch Position	Wiper operation
HI	High speed

*1 When the wiper lever is switched to the **AUTO** position, the indicator light turns on.

Auto-wiper control

When the wiper lever is in the **AUTO** position, the rain sensor senses the amount of rainfall on the windscreen and turns the wipers on or off automatically (off—intermittent—low speed—high speed).

The sensitivity of the rain sensor can be adjusted by turning the switch on the wiper lever.

From the centre position (normal), rotate the switch upward (+ direction) for higher sensitivity (faster response) or rotate it downward (- direction) for less sensitivity (slower response).

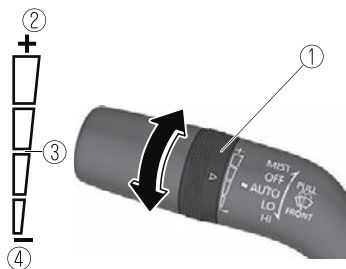

1. Switch
2. Higher sensitivity
3. Centre position
4. Less sensitivity

CAUTION

- Do not shade the rain sensor by adhering a sticker or a label on the windscreen. Otherwise the rain sensor will not operate correctly.



- When the wiper lever is in the **AUTO** position and the ignition is switched ON, the wipers may move automatically in the following cases:

- If the windscreen above the rain sensor is touched or wiped with a cloth.
- If the windscreen is struck with a hand or other object from either outside or inside the vehicle.

Keep hands and scrapers clear of the windscreen when the wiper lever is in the **AUTO** position and the ignition is switched ON as fingers could be pinched or the wipers and wiper blades damaged when the wipers activate automatically. If you are going to clean the windscreen, be sure the wipers are turned off completely (when it is most likely that the engine is left running) this is particularly important when clearing ice and snow.

Switches and Controls

NOTE

- Switching the auto-wiper lever from the **OFF** to the **AUTO** position while driving activates the windscreen wipers once, after which they operate according to the rainfall amount.
- The auto-wiper control may not operate when the rain sensor temperature is about $-10\text{ }^{\circ}\text{C}$ ($14\text{ }^{\circ}\text{F}$) or lower, or about $85\text{ }^{\circ}\text{C}$ ($185\text{ }^{\circ}\text{F}$) or higher.
- If the windscreen is coated with water repellent, the rain sensor may not be able to sense the amount of rainfall correctly and the auto-wiper control may not operate properly.
- If dirt or foreign matter (such as ice or matter containing salt water) adheres to the windscreen above the rain sensor, or if the windscreen is iced, it could cause the wipers to move automatically. However, if the wipers cannot remove this ice, dirt or foreign matter, the auto-wiper control will stop operation. In this case, set the wiper lever to the low speed position or high speed position for manual operation, or remove the ice, dirt or foreign matter by hand to restore the auto-wiper operation.
- If the auto-wiper lever is left in the **AUTO** position, the wipers could operate automatically from the effect of strong light sources, electromagnetic waves, or infrared light because the rain sensor uses an optical sensor. It is recommended that the auto-wiper lever be switched to the **OFF** position other than when driving the vehicle under rainy conditions.
- The auto-wiper control functions can be turned off.

4-58

Refer to the Settings section in the MZD Connect Owner's Manual.

▼ Windscreen Washer

Pull the wiper lever toward you to spray washer fluid and operate the windscreen wipers several times.

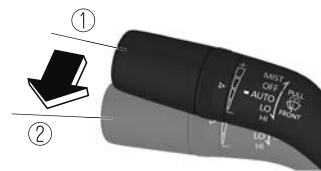

1. OFF
2. Washer

NOTE

- If the windscreen washer is turned on when the windscreen wipers are not operating, the windscreen wipers operate a few times.
- If you pull the wiper lever toward you once, washer fluid is sprayed only while the windscreen wipers move out of their stowed positions to the point where they start reversing back. Therefore, if you pull the wiper lever while the windscreen wipers are reversing back to their stowed positions, the next time the washer fluid is sprayed is during the next cycle.

If the washer does not work, inspect the fluid level (page 6-17). If the fluid level is normal, consult an expert repairer, we recommend an Authorised Mazda Repairer.

Switches and Controls

Rear Window Wiper and Washer*

▼ Rear Window Wiper and Washer

The ignition must be switched ON to use the wiper.

▼ Rear Window Wiper

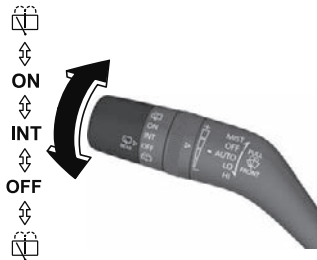

Turn the wiper on by turning the rear wiper/washer switch.

Switch Position	Wiper operation
ON	Normal
INT	Intermittent
OFF	Stop

▼ Rear Window Washer

To spray washer fluid, turn the rear wiper/washer switch to either of the  position. After the switch is released, the washer will stop.

NOTE

While the windscreen washers are operating (from the time the wiper lever is pulled until the washer fluid stops spraying), the rear window washer does not spray washer fluid even if you operate the switch.

If the washer does not work, inspect the fluid level (page 6-17). If the fluid level is normal and the washer still does not work, consult an expert repairer, we recommend an Authorised Mazda Repairer.

*Some models. **4-59**

Switches and Controls

Rear Window Defogger

▼ Rear Window Defogger

The rear window defogger clears fog from the rear window.

The ignition must be switched ON to use the defogger.

Press the switch to turn on the rear window defogger. The rear window defogger operates for about 15 minutes and then turns off automatically. The indicator light illuminates when the defogger is operating.

To turn off the rear window defogger before the 15 minutes has elapsed, press the switch again.



1. Indicator light

CAUTION

➤ Do not use sharp instruments or window cleaners with abrasives to clean the inside of the rear window surface. They may damage the defogger grid inside the window.

NOTE

- This defogger is not designed for melting snow. If there is an accumulation of snow on the rear window, remove it before using the defogger.
- The rear window defogger operation time can be changed from 15 minutes to continuous operation. When the operation time has been switched to continuous operation, by pressing the switch, the rear window defogger will continue to operate until the ignition is switched OFF. Refer to the Settings section in the MZD Connect Owner's Manual.

▼ Mirror Defogger*

The mirror defoggers defrost the outside mirrors.

The mirror defoggers operate in conjunction with the rear window defogger.

To turn on the mirror defoggers, switch the ignition ON and press the rear window defogger switch (page 4-60).

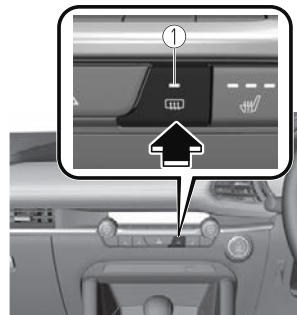

1. Indicator light

Switches and Controls

Horn

▼ Horn

To sound the horn, press the  mark on the steering wheel.

Hazard Warning Flasher

▼ Hazard Warning Flasher

The hazard warning lights should always be used when you stop on or near a roadway in an emergency.



The hazard warning lights warn other drivers that your vehicle is a traffic hazard and that they must take extreme caution when near it.



Depress the hazard warning flasher and all the direction indicators will flash. The hazard warning indicator lights in the instrument cluster flash simultaneously.

NOTE

- The direction indicators do not work when the hazard warning lights are on.
- Check local regulations about the use of hazard warning lights while the vehicle is being towed to verify that it is not in violation of the law.

When Driving

Switches and Controls

- *If the brake pedal is depressed while driving on slippery roads, the emergency stop signal system could operate causing all the turn and lane change signals to flash. Refer to Emergency Stop Signal System on page 4-73.*
- *While the emergency stop signal system is operating, all the direction indicators automatically flash rapidly to caution the driver of a vehicle following behind your vehicle of a sudden braking situation. Refer to Emergency Stop Signal System on page 4-73.*

4-62

Brake System

▼ Foot Brake

This vehicle has power-assisted brakes that adjust automatically through normal use.

Should power-assist fail, you can stop by applying greater force than normal to the brake pedal. But the distance required to stop will be greater than usual.

⚠ WARNING

Do not coast with the engine stalled or turned off, find a safe place to stop:

Coasting with the engine stalled or turned off is dangerous. Braking will require more effort, and the brake's power-assist could be depleted if you pump the brake. This will cause longer stopping distances or even an accident.

Shift to a lower gear when going down steep hills:

Driving with your foot continuously on the brake pedal or steadily applying the brakes for long distances is dangerous. This causes overheated brakes, resulting in longer stopping distances or even total brake failure. This could cause loss of vehicle control and a serious accident. Avoid continuous application of the brakes.

Dry off brakes that have become wet by driving slowly, releasing the accelerator pedal and lightly applying the brakes several times until the brake performance returns to normal:

Driving with wet brakes is dangerous. Increased stopping distance or the vehicle pulling to one side when braking could result in a serious accident. Light braking will indicate whether the brakes have been affected.

⚠ CAUTION

- Do not drive with your foot held on the clutch pedal or brake pedal, or hold the clutch pedal depressed halfway unnecessarily. Doing so could result in the following:
 - The clutch and brake parts will wear out more quickly.
 - The brakes can overheat and adversely affect brake performance.
- Always depress the brake pedal with the right foot. Applying the brakes with the unaccustomed left foot could slow your reaction time to an emergency situation resulting in insufficient braking operation.

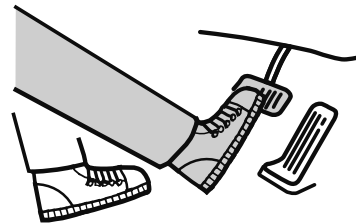

- Wear shoes appropriate for driving in order to avoid your shoe contacting the brake pedal when depressing the accelerator pedal.

Brake

▼ Electric Parking Brake (EPB)

The EPB system applies the parking brake using an electric motor. The system can operate automatically and manually. The EPB switch indicator light turns on when applying the parking brake and it turns off when releasing the parking brake.

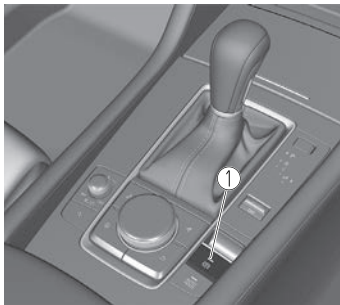

1. Indicator light

WARNING

Do not drive the vehicle with the parking brake applied:

If the vehicle is driven with the parking brake applied, the brake parts may generate heat and the brake system may not operate, leading to an accident. Before driving the vehicle, release the parking brake and make sure that the EPB indicator light in the instrument cluster turns off.

Apply the parking brake when leaving the vehicle:

Not applying the parking brake when parking the vehicle is dangerous as the vehicle may move unexpectedly and result in an accident. Before leaving the vehicle, apply the parking brake and make sure that the EPB indicator light in the instrument cluster turns on.

NOTE

- The parking brake cannot be applied or released while the vehicle battery is dead.
Refer to *If a Jump-Starting* on page 7-13.
- When the charging system warning light in the instrument cluster turns on, the parking brake cannot be applied after switching the ignition OFF. Before switching the ignition OFF, apply the parking brake manually.
- The sound of the parking brake being applied or released can be heard, however, this does not indicate a problem.
- If the EPB is not used for long periods, an automatic inspection of the system is performed while the vehicle is parked. An operation sound can be heard, however, this does not indicate a problem.
- When applying the parking brake and switching OFF the ignition, an operation sound can be heard, however, this does not indicate a problem.
- The brake pedal may move while applying or releasing the parking brake, however, this does not indicate a problem.

- *If there is a problem with the brake system (foot brake) while driving the vehicle, continually pulling up the EPB switch will apply the brakes and decelerate or stop the vehicle. The parking brake on-reminder sound is activated while the brake is applied. In addition, when releasing the switch, the brake is released and the sound stops.*
- *If the parking brake is applied with the ignition switched OFF or in ACC, the EPB indicator light in the instrument cluster and the indicator light in the switch may turn on for 15 seconds.*
- *When using an automatic car wash which moves the vehicle with the front tyres mounted, it is necessary to cancel the parking brake auto operation before the vehicle enters the automatic car wash. For details, refer to Cancelling the parking brake automatic operation.*

Manual operation

Applying the parking brake manually

When the brake pedal is firmly depressed and the EPB switch is pulled up, the parking brake is applied regardless of the ignition position. When the parking brake is applied, the EPB indicator light in the instrument cluster and the EPB switch indicator light turn on.

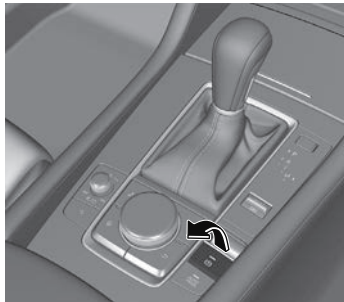

Releasing the parking brake manually

When the parking brake is firmly depressed and the EPB switch is pressed while the ignition is switched ON or the engine is running, the parking brake is released. When the parking brake is released, the EPB indicator light in the instrument cluster and the EPB switch indicator light turn off.



If the EPB switch is pressed without depressing the brake pedal, a message is displayed on the multi-information display to notify the driver to depress the brake pedal.

Refer to Message Indicated on Multi-information Display on page 7-34.

Auto operation

Applying the parking brake automatically

When the ignition is switched from ON to ACC or OFF, the parking brake will be applied automatically. When the parking brake is applied, the EPB indicator light in the instrument cluster and the EPB switch indicator light turn on.

Brake

NOTE

To release the parking brake when the ignition is switched OFF, it is necessary to cancel the parking brake auto operation. For details, refer to Cancelling the parking brake automatic operation.

Releasing the parking brake automatically

If the accelerator pedal is depressed with the parking brake applied and all of the following conditions met, the parking brake is released automatically. When the parking brake is released, the EPB indicator light in the instrument cluster and the EPB switch indicator light turn off.

- The engine is running.
- The driver's door is closed.
- The driver's seat belt is fastened.
- **(Manual transmission vehicle)**
 - The shift lever is in a position other than neutral.
 - The clutch pedal is depressed halfway.
- **(Automatic transmission vehicle)**

The selector lever is in the D, M, or R position.

NOTE

If something such as the driver's foot contacts the accelerator pedal with the engine running and the parking brake applied, the parking brake might be released automatically. If you do not intend to start driving the vehicle immediately, shift the shift lever to the neutral position for a manual transmission, or shift the selector lever to the P or N position for an automatic transmission.

4-66

Cancelling the parking brake automatic operation

The parking brake automatic operation can be cancelled by doing any of the following after switching the ignition from ON to OFF.

Auto operation cancel method 1

1. Switch the ignition ON.
2. Turn off the AUTOHOLD.
3. Press the EPB switch continuously for 2 seconds or longer (until a sound is activated).
4. Release the EPB switch and switch the ignition OFF within 5 seconds after the sound was activated.

After the auto operation is cancelled, a sound is activated one time, and the EPB switch indicator light switches from illumination to flashing, and then turns off after 3 seconds.

Auto operation cancel method 2

1. Switch the ignition ON.
2. Turn off the AUTOHOLD.
3. Switch the ignition OFF with the EPB switch pressed.

When the auto operation is cancelled, a sound is activated one time, and the EPB switch indicator light from normal flashing to faster flashing, and then turns off after 3 seconds.

NOTE

- *When cancelling the parking brake auto operation and parking the vehicle, shift the shift lever to the 1st gear or the R position for a manual transmission, or shift the selector lever to the P position for an automatic transmission, and then use wheel blocks.*

- *The auto operation may not cancel if the vehicle is parked on a steep slope.*

When the ignition is switched ON, the parking brake auto operation is restored.

▼ Warning Light

The warning light turns on when the system has a malfunction.
Refer to Brake System Warning Indication/Warning Light on page 7-23.

▼ Brake Pad Wear Indicator

When the disc brake pads become worn, the built-in wear indicators contact the disc plates. This causes a screeching noise to warn that the pads should be replaced.



When you hear this noise, consult an expert repairer, we recommend an Authorised Mazda Repairer as soon as possible.

⚠ WARNING

Do not drive with worn disc pads:
Driving with worn disc pads is dangerous. The brakes could fail and cause a serious accident. As soon as you hear a screeching noise consult an expert repairer, we recommend an Authorised Mazda Repairer.

NOTE

In high humidity weather conditions, brake noises, such as brake squeak or brake squeal can be heard. It does not indicate a malfunction.

▼ Brake Assist

During emergency braking situations when it is necessary to depress the brake pedal with greater force, the brake assist system provides braking assistance, thus enhancing braking performance.

When the brake pedal is depressed hard or depressed more quickly, the brakes apply more firmly.

NOTE

- *When the brake pedal is depressed hard or depressed more quickly, the pedal will feel softer but the brakes will apply more firmly. This is a normal effect of the brake assist operation and does not indicate a malfunction.*
- *When the brake pedal is depressed hard or depressed more quickly, a motor/pump operation noise may be heard. This is a normal effect of the brake assist and does not indicate a malfunction.*
- *The brake assist equipment does not supersede the functionality of the vehicle's main braking system.*

▼ Brake Override System

The brake override system applies the brake first for safety if the brake pedal and accelerator pedal are depressed at the same time.

When Driving

Brake

NOTE

Operation of the brake override system can be turned on or off. Refer to the Settings section in the MZD Connect Owner's Manual.

AUTOHOLD

▼ AUTOHOLD

The AUTOHOLD function automatically holds the vehicle stopped, even if you take your foot off the brake pedal. This function can be best used while stopped in traffic or at a traffic light. The brakes are released when you resume driving the vehicle such as by releasing the clutch pedal with the shift lever shifted to a position other than the neutral position (manual transmission vehicle) or depressing the accelerator pedal (automatic transmission vehicle).

WARNING

Do not rely completely on the AUTOHOLD function:

The AUTOHOLD function is only designed to assist the brake operation while the vehicle is stopped. Neglecting to operate the brakes and relying only on the AUTOHOLD system is dangerous and could result in an unexpected accident if the vehicle were to suddenly move. Operate the brakes appropriately in accordance with the road and surrounding conditions.

Do not release your foot from the brake pedal while the vehicle is stopped on a steep grade:

Because there is a possibility of the vehicle not being held in the stopped position by the AUTOHOLD function, the vehicle may move unexpectedly and result in an accident.

Do not use the AUTOHOLD function on slippery roads such as icy or snow-covered roads, or unpaved roads:

Even if the vehicle is held in the stopped position by the AUTOHOLD function, the vehicle may move unexpectedly and result in an accident. Operate the accelerator pedal, brakes, or steering wheel appropriately as necessary.

Immediately depress the brake pedal in the following cases:

Because the AUTOHOLD function is cancelled forcibly, the vehicle may move unexpectedly and result in an accident.

- *“Depress Brake Pedal. Brake Hold Disabled” is displayed in the multi-information display and the warning sound is activated at the same time.*

Always apply the parking brake when parking the vehicle:

Not applying the parking brake when parking the vehicle is dangerous as the vehicle may move unexpectedly and result in an accident. When parking the vehicle, shift the selector lever to the P position (automatic transmission vehicle) and apply the parking brake.



Brake

CAUTION

If you stop operating the accelerator pedal before the vehicle starts moving, the force holding the vehicle in the stopped position may weaken. Firmly depress the brake pedal or depress the accelerator pedal to accelerate the vehicle.

NOTE

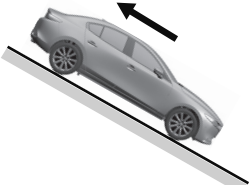
- Under the following conditions, a problem with the AUTOHOLD is occurring. Have your vehicle inspected at an expert repairer; we recommend an Authorised Mazda Repairer as soon as possible.
 - A message is indicated on the multi-information display and a warning sound is activated for about 5 seconds while the AUTOHOLD is operating or when you press the AUTOHOLD switch.
 - If you switch the ignition OFF while the AUTOHOLD is operating, the parking brake is applied automatically to assist you with parking the vehicle.
 - The AUTOHOLD is cancelled when the selector lever/shift lever is shifted to R position while the vehicle is on level ground, or facing up a hill or grade (as shown below).

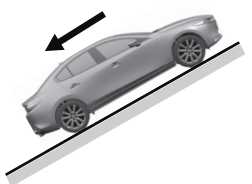
Vehicle posture and road surface gradient		AUTOHOLD operation status
Vehicle tilts forward		Operates
Level ground		Does not operate, cancelled
Vehicle tilts rearward		Does not operate, cancelled

 : Reverse driving (selector lever/shift lever in the reverse (R) position)

▼ **AUTOHOLD System is Turned On**

Press the AUTOHOLD switch and when the AUTOHOLD standby indicator light turns on, the AUTOHOLD function turns on.



1. AUTOHOLD standby indicator light

NOTE

When all of the following conditions are met, the AUTOHOLD standby indicator light turns on when the AUTOHOLD switch is pressed and the AUTOHOLD function turns on.

- The ignition is switched ON (engine is running or stopped by i-stop).
- The driver's seat belt is fastened.
- The driver's door is closed.
- There is no problem with the AUTOHOLD function.

To operate AUTOHOLD and hold the brakes

1. Depress the brake pedal and bring the vehicle to a complete stop.
2. The AUTOHOLD active indicator light in the instrument cluster turns on and the brakes are held.

HOLD

3. The vehicle is held in its stopped position even with the brake pedal released.

NOTE

When all of the following conditions are met, the AUTOHOLD operates and the brakes are held.

- The ignition is switched ON (engine is running or stopped by i-stop).
- The vehicle is stopped.
- The brake pedal is being depressed.
- The AUTOHOLD active indicator light turns on.
- The accelerator pedal is not depressed.
- The driver's seat belt is fastened.
- The driver's door is closed.
- There is no problem with the AUTOHOLD function.
- The parking brake is released.
- There is no problem with the Electric Parking Brake (EPB) function.
- **(Automatic transmission vehicle)**
The selector lever is in a position other than R position or the vehicle tilts forward with the selector lever in the R position.

To release AUTOHOLD and start driving the vehicle

If you do any of the following actions to resume driving the vehicle, the brakes release automatically and the AUTOHOLD active indicator light turns off.

- **(Manual transmission vehicle)**
You start to release the clutch pedal with the shift lever shifted to a position other than the neutral position
- **(Automatic transmission vehicle)**
 - The accelerator pedal is depressed.

Brake

- The vehicle tilts rearward or the selector lever is shifted to the R position on level ground.

NOTE

- If the Electric Parking Brake (EPB) switch is pulled while the AUTOHOLD is operating, the parking brake is applied and the AUTOHOLD is released. In addition, if the parking brake is released under this condition, the AUTOHOLD operates to hold the brakes.
- Under the following conditions, the parking brake is automatically applied and the AUTOHOLD is released. The AUTOHOLD is re-enabled when the conditions before the AUTOHOLD is released are restored.
 - The driver's seat belt is unfastened.
 - The driver's door is opened.
- When about 10 minutes or longer have passed since the AUTOHOLD operation started, the parking brake is automatically applied. Because the AUTOHOLD is restored when releasing the parking brake, the hold on the brakes by AUTOHOLD function resumes.
- **(Manual transmission vehicle)**
When starting to drive the vehicle forward or in reverse on a down slope, depress the clutch pedal and shift the shift lever to the appropriate position for driving in the desired direction, and then depress the accelerator pedal to release the AUTOHOLD.

- The AUTOHOLD can be cancelled forcibly by fully depressing the accelerator pedal for 1 second or longer while the AUTOHOLD is operating. Forcibly cancel the AUTOHOLD only when the AUTOHOLD cannot be cancelled due to a system malfunction or it is necessary to cancel the AUTOHOLD in an emergency.

▼ AUTOHOLD System is Turned Off

Depress the brake pedal and press the AUTOHOLD switch. The AUTOHOLD is turned off and the AUTOHOLD standby indicator light turns off.



1. AUTOHOLD standby indicator light

NOTE

- When the brakes are not held such as while driving the vehicle, the AUTOHOLD can be turned off only by pressing the AUTOHOLD switch.

- If the AUTOHOLD switch is pressed without depressing the brake pedal while AUTOHOLD is operating (AUTOHOLD active indicator light in instrument cluster is turned on), the message “Depress Brake Pedal and Operate Switch to Release” is indicated on the multi-information display to notify the driver to depress the brake pedal.
- If any of the following conditions occurs while the AUTOHOLD function is operating (AUTOHOLD active indicator light is turned on), the parking brake is applied automatically and the AUTOHOLD function turns off. For the Electric Parking Brake (EPB) operation, refer to the Electric Parking Brake (EPB) on page 4-64.
 - The ignition is switched OFF.
 - There is a problem with the AUTOHOLD function.

Emergency Stop Signal System

▼ Emergency Stop Signal System

If you apply the brakes suddenly while driving at a speed of about 55 km/h (34 mph) or faster, the emergency stop signal system automatically and rapidly flashes all the direction indicator lights to caution drivers behind your vehicle of the sudden braking situation.

NOTE

· **Flashing**

When you bring your vehicle to a complete stop while all the direction indicator lights are flashing rapidly, the rapid flashing of all the direction indicator lights changes back to the normal flashing pattern. The direction indicator lights turn off when you release your foot from the brake pedal.

· **Operation**

- *When the ABS operates, the emergency stop signal system is more likely to operate. Therefore, if the brake pedal is depressed on a slippery road, all of the direction indicator lights may flash.*
- *The emergency stop signal system does not operate when the hazard warning light switch is pressed.*

Hill Launch Assist (HLA)

▼ Hill Launch Assist (HLA)

The HLA functions to assist in accelerating the vehicle from a stop on slopes. When releasing the brake pedal and depressing the accelerator pedal to accelerate the vehicle from a stop while on a slope, the function prevents the vehicle from rolling. The HLA also operates when reversing on a slope.

The braking force is maintained automatically after releasing the brake pedal on a steep slope.

For manual transmission vehicles, the HLA operates when the vehicle is tilted rearward with the shift lever in a forward gear, and operates when the vehicle is tilted forward with the shift lever in the R position.

For automatic transmission vehicles, the HLA operates when the vehicle is tilted rearward with the selector lever in a forward gear, and operates when the vehicle is tilted forward with the selector lever in the R position.

WARNING

Do not rely completely on HLA:

HLA is an auxiliary device for accelerating from a stop on a slope. The system only operates for about 2 seconds and therefore, relying only on the system, when accelerating from a stop is dangerous because the vehicle may move (roll) unexpectedly and cause an accident.

The vehicle could roll depending on the vehicle's load or if it is towing something. In addition, for vehicles with a manual transmission, the vehicle could still roll depending on how the clutch pedal or the accelerator pedal is operated.

Always confirm the safety around the vehicle before starting to drive the vehicle.

NOTE

- *HLA does not operate on a gentle slope. In addition, the gradient of the slope on which the system will operate changes depending on the vehicle's load.*
- *HLA does not operate if the parking brake is applied, the vehicle has not stopped completely, or the clutch pedal is released.*
- *While HLA is operating, the brake pedal may feel stiff and vibrate, however, this does not indicate a malfunction.*
- *HLA does not operate while the TCS/DSC indicator light is illuminated. Refer to TCS/DSC Indication/Indicator Light (Turns on) on page 7-28.*
- *HLA does not turn off even if the DSC OFF switch is pressed to turn off the TCS/DSC.*
- **(Automatic Transmission)**
Although the HLA does not operate during idling stop, the vehicle roll prevention function operates to prevent vehicle roll.

Antilock Brake System (ABS)

▼ Antilock Brake System (ABS)

The ABS control unit continuously monitors the speed of each wheel. If one wheel is about to lock up, the ABS responds by automatically releasing and reapplying that wheel's brake.

The driver will feel a slight vibration in the brake pedal and may hear a chattering noise from the brake system. This is normal ABS system operation. Continue to depress the brake pedal without pumping the brakes.

The warning light turns on when the system has a malfunction. Refer to ABS Warning Indication/Warning Light on page 7-26.

⚠ WARNING

Do not rely on ABS as a substitute for safe driving:

The ABS cannot compensate for unsafe and reckless driving, excessive speed, tailgating (following another vehicle too closely), driving on ice and snow, and hydroplaning (reduced tyre friction and road contact because of water on the road surface). You can still have an accident.

NOTE

- *Braking distances may be longer on loose surfaces (snow or gravel, for example) which usually have a hard foundation. A vehicle with a normal braking system may require less distance to stop under these conditions because the tyres will build up a wedge of surface layer when the wheels skid.*
- *The sound of the ABS operating may be heard when starting the engine or immediately after starting the vehicle, however, it does not indicate a malfunction.*

Traction Control System (TCS)

▼ Traction Control System (TCS)

The Traction Control System (TCS) enhances traction and safety by controlling engine torque and braking. When the TCS detects driving wheel slippage, it lowers engine torque and operates the brakes to prevent loss of traction.

This means that on a slick surface, the engine adjusts automatically to provide optimum power to the drive wheels, limiting wheel spin and loss of traction.

The warning light turns on when the system has a malfunction.

Refer to TCS/DSC Indication/Indicator Light (Turns on) on page 7-28.

WARNING

Do not rely on the Traction Control System (TCS) as a substitute for safe driving:

The Traction Control System (TCS) cannot compensate for unsafe and reckless driving, excessive speed, tailgating (following another vehicle too closely), and hydroplaning (reduced tyre friction and road contact because of water on the road surface). You can still have an accident.

Use snow tyres or tyre chains and drive at reduced speeds when roads are covered with ice and/or snow:

Driving without proper traction devices on snow and/or ice-covered roads is dangerous. The Traction Control System (TCS) alone cannot provide adequate traction and you could still have an accident.

NOTE

To turn off the TCS, press the DSC OFF switch (page 4-78).

▼ TCS/DSC Indicator Light



This indicator light stays on for a few seconds when the ignition is switched ON. If the TCS or DSC is operating, the indicator light flashes.

If the light stays on, the TCS, DSC or the brake assist system may have a malfunction and they may not operate correctly. Take your vehicle to an expert repairer, we recommend an Authorised Mazda Repairer.

NOTE

- In addition to the indicator light flashing, a slight labouring sound will come from the engine. This indicates that the TCS/DSC is operating properly.*
- On slippery surfaces, such as fresh snow, it will be impossible to achieve high rpm when the TCS is on.*

Dynamic Stability Control (DSC)

▼ Dynamic Stability Control (DSC)

The Dynamic Stability Control (DSC) automatically controls braking and engine torque in conjunction with systems such as ABS and TCS to help control side slip when driving on slippery surfaces, or during sudden or evasive manoeuvring, enhancing vehicle safety.

Refer to ABS (page 4-75) and TCS (page 4-76).

DSC operation is possible at speeds greater than 20 km/h (12 mph).

The warning light turns on when the system has a malfunction.
Refer to TCS/DSC Indication/Indicator Light (Turns on) on page 7-28.

WARNING

Do not rely on the Dynamic Stability Control as a substitute for safe driving:
The Dynamic Stability Control (DSC) cannot compensate for unsafe and reckless driving, excessive speed, tailgating (following another vehicle too closely), and hydroplaning (reduced tyre friction and road contact because of water on the road surface). You can still have an accident.

CAUTION

- The DSC may not operate correctly unless the following are observed:
 - Use tyres of the correct size specified for your Mazda on all 4 wheels.
 - Use tyres of the same manufacturer, brand and tread pattern on all 4 wheels.
 - Do not mix worn tyres.
- The DSC may not operate correctly when tyre chains are used or a temporary spare tyre is installed because the tyre diameter changes.

NOTE

If there is a problem with the DSC, the Hill Launch Assist (HLA) may not operate. Refer to Hill Launch Assist (HLA) on page 4-74.

▼ TCS/DSC Indicator Light



This indicator light stays on for a few seconds when the ignition is switched ON. If the TCS or DSC is operating, the indicator light flashes.

If the light stays on, the TCS, DSC or the brake assist system may have a malfunction and they may not operate correctly. Take your vehicle to an expert repairer, we recommend an Authorised Mazda Repairer.

▼ DSC OFF Indicator Light



This indicator light stays on for a few seconds when the ignition is switched ON. It also illuminates when the DSC OFF switch is pressed and TCS/DSC is switched off.

Refer to DSC OFF Switch on page 4-78.

If the light remains illuminated and the TCS/DSC is not switched off, take your vehicle to an expert repairer, we recommend an Authorised Mazda Repairer. The DSC may have a malfunction.

▼ DSC OFF Switch

Press the DSC OFF switch to turn off the TCS/DSC. The DSC OFF indicator light in the instrument cluster and the DSC OFF switch indicator light will illuminate.

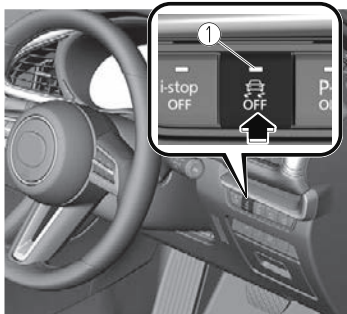

1. DSC OFF switch indicator light

Press the switch again to turn the TCS/DSC back on. The DSC OFF indicator light and the DSC OFF switch indicator light will turn off.

4-78

NOTE

- When DSC is on and you attempt to free the vehicle when it is stuck, or drive it out of freshly fallen snow, the TCS (part of the DSC system) will activate. Depressing the accelerator will not increase engine power and freeing the vehicle may be difficult. When this happens, turn off the TCS/DSC.
- If the TCS/DSC is off when the engine is turned off, it automatically activates when the ignition is switched ON.
- Leaving the TCS/DSC on will provide the best traction.
- If the DSC OFF switch is pressed and held for 10 seconds or more, the DSC OFF switch malfunction detection function operates and the DSC system activates automatically. The DSC OFF indicator light turns off while the DSC system is operative.
- If the Smart Brake Support (SBS) operates with the TCS/DSC turned off, the TCS/DSC becomes operational automatically.

Drive Selection*

▼ Drive Selection

Drive selection is a system to switch the vehicle's drive mode. When the sport mode is selected, vehicle's response against accelerator operation is enhanced. This provides additional quick acceleration which may be needed to safely make manoeuvres such as lane changes, merging onto freeways, or passing other vehicles.



Do not use the sport mode when driving on slippery roads such as wet or snow-covered roads. It may cause tyre slipping.

NOTE

- When the sport mode is selected, driving at higher engine speeds increases and it may increase fuel consumption. Mazda recommends that you cancel the sport mode on normal driving.
- Drive mode cannot be switched in the following conditions:
 - ABS/TCS/DSC is operating
 - Cruise control* is operating.
 - The Mazda Radar Cruise Control with Stop & Go function (MRCC with Stop & Go function) System* is operating.
 - Cruising & Traffic Support (CTS)* is operating.
 - Steering wheel is being operated abruptly

▼ Drive Selection Switch

Press the drive selection switch forward (SPORT) to select the sport mode.
Pull the drive selection switch back (OFF) to cancel the sport mode.



NOTE

- In the following cases, the drive selection is cancelled.
 - The ignition is switched OFF.
 - Cruise Control is set.
 - Mazda Radar Cruise Control with Stop & Go function (MRCC with Stop & Go function) is set.
 - Cruising & Traffic Support (CTS) is set.
- Depending on the driving conditions when sport mode is selected, the vehicle may perform shift-down or slightly accelerate.

*Some models.

When Driving

Drive Selection

▼ Select Mode Indicator Light

When the sport mode is selected, the select mode indicator light turns on in the instrument cluster.

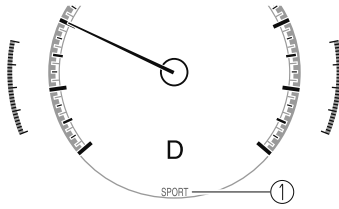

1. Select mode indicator light

NOTE

If the drive selection cannot be switched to sport mode, the select mode indicator light flashes to notify the driver.

Power Steering

▼ Power Steering

- Power steering is only operable when the engine is running. If the engine is off or if the power steering system is inoperable, you can still steer, but it requires more physical effort. If the steering feels stiffer than usual during normal driving or the steering vibrates, consult an expert repairer, we recommend an Authorised Mazda Repairer.
- The warning indication notifies the driver of system abnormalities and operation conditions. Refer to Power Steering Malfunction Indication/Indicator Light on page 7-25.

CAUTION

Never hold the steering wheel to the extreme left or right for more than 5 seconds with the engine running. This could damage the power steering system.

i-ACTIVSENSE

▼ **i-ACTIVSENSE**

i-ACTIVSENSE is a collective term covering a series of advanced safety and driver support systems which make use of cameras and sensors. The systems consist of active safety and pre-crash safety systems.

These systems are designed to assist the driver in safer driving by reducing the load on the driver and helping to avert collisions or reduce their severity.

However, because each system has its limitations, always drive carefully and do not rely solely on the systems.

▼ **Active Safety Technology**

Active Safety Technology supports safer driving by helping the driver to recognise potential hazards and avert accidents.

Driver awareness support systems

Nighttime visibility

- Adaptive LED Headlights (ALH).....page 4-90
- High Beam Control System (HBC)page 4-87

Left/right side and rear side detection

- Lane Departure Warning System (LDWS).....page 4-92
- Blind Spot Monitoring (BSM).....page 4-96

Road sign recognition

- Traffic Sign Recognition System (TSR)..... page 4-101

4-82

Inter-vehicle distance recognition

- Distance & Speed Alert (DSA).....page 4-108

Front obstruction detection when passing cross

- Front Cross Traffic Alert (FCTA)page 4-113

Rear obstruction detection when leaving a parking space

- Rear Cross Traffic Alert (RCTA).....page 4-116

Full-surround recognition

- 360°View Monitor..... page 4-175

Driver fatigue detection

- Driver Attention Alert (DAA)page 4-109
- Driver Monitoring (DM)..... page 4-111

Driver support systems

Inter-vehicle distance

- Mazda Radar Cruise Control (MRCC)..... page 4-120
- Mazda Radar Cruise Control with Stop & Go function (MRCC with Stop & Go function).....page 4-128

Lane departure

- Lane-keep Assist System (LAS).....page 4-154

Inter-vehicle distance and lane keeping

- Cruising & Traffic Support (CTS).....page 4-138

Speed control

- Intelligent Speed Assistance (ISA)page 4-158

▼ Pre-Crash Safety Technology

Pre-crash safety technology is designed to assist the driver in averting collisions or reducing their severity in situations where they cannot be avoided.

Collision damage reduction**Forward driving**

Smart Brake Support (SBS).....page 4-164

Reverse driving

Smart Brake Support [Rear]
(SBS-R)..... page 4-166
Smart Brake Support [Rear Crossing]
(SBS-RC).....page 4-170

▼ Camera and Sensors**Forward Sensing Camera (FSC)**

The Forward Sensing Camera (FSC) detects lane indications and recognises headlights, tail lights and city lights during nighttime driving. In addition, it also detects the vehicle ahead, pedestrians, or obstructions. The following systems use the Forward Sensing Camera (FSC).

- High Beam Control system (HBC)
- Adaptive LED Headlights (ALH)
- Lane Departure Warning System (LDWS)
- Traffic Sign Recognition System (TSR)
- Distance & Speed Alert (DSA)
- Driver Attention Alert (DAA)
- Driver Monitoring (DM)
- Mazda Radar Cruise Control (MRCC)
- Mazda Radar Cruise Control with Stop & Go function (MRCC with Stop & Go function)
- Lane-keep Assist System (LAS)
- Cruising & Traffic Support (CTS)
- Smart Brake Support (SBS)

The Forward Sensing Camera (FSC) is installed at the top of the windscreen near the rearview mirror.

Refer to Forward Sensing Camera (FSC) on page 4-206.

Front radar sensor

The front radar sensor detects radio waves reflected off a vehicle ahead sent from the radar sensor. The following systems use the front radar sensor.

- Distance & Speed Alert (DSA)
- Mazda Radar Cruise Control (MRCC)
- Mazda Radar Cruise Control with Stop & Go function (MRCC with Stop & Go function)
- Cruising & Traffic Support (CTS)
- Smart Brake Support (SBS)

The front radar sensor is mounted behind the radiator grille.

Refer to Front Radar Sensor on page 4-210.

Front side radar sensor

The front side radar sensors detect radio waves reflected off a vehicle ahead sent from the radar sensor. The following systems use the front side radar sensor.

- Front Cross Traffic Alert (FCTA)

The front side radar sensors are installed inside the front bumper, one on the left side and one on the right side.

Refer to Front Side Radar Sensor on page 4-213.

Rear side radar sensor

The rear side radar sensors detect radio waves reflected off a vehicle approaching from the rear or an obstruction sent from the radar sensors. The following systems use the rear side radar sensor.

- Blind Spot Monitoring (BSM)
- Rear Cross Traffic Alert (RCTA)
- Smart Brake Support [Rear Crossing] (SBS-RC)

The rear side radar sensors are installed inside the rear bumper, one on the left side and one on the right side.

Refer to Rear Side Radar Sensor on page 4-214.

Rear/rear corner/rear side ultrasonic sensor

The ultrasonic sensor detects ultrasonic waves reflected off obstructions at the rear sent from the ultrasonic sensors. The following systems use the ultrasonic sensor.

- Smart Brake Support [Rear] (SBS-R)
- Smart Brake Support [Rear Crossing] (SBS-RC)

The ultrasonic sensors are mounted in the rear bumper.

Refer to Rear/Rear corner/Rear Side Ultrasonic Sensor on page 4-216.

Front camera/side cameras/rear camera

The front camera, side cameras, and rear camera shoot images of the area surrounding the vehicle. The 360°View Monitor uses each camera.

Cameras are installed to the front bumper, door mirrors, and rear bumper.

Refer to Front Camera/Side Cameras/Rear Camera on page 4-216.

Driver monitoring camera

The driver monitoring camera detects changes in the driver's facial features and estimates the amount of accumulated fatigue and sleepiness of the driver. The following systems use the driver monitoring camera.

- Driver Monitoring (DM)

The driver monitoring camera is mounted in the centre display.

Refer to Driver Monitoring Camera on page 4-217.

▼ i-ACTIVSENSE Status Symbol (Warning/Risk Avoidance Support System)

The driver is notified of the status of the following systems using the i-ACTIVSENSE status symbol (warning/risk avoidance support system).

- Lane Departure Warning System (LDWS)
- Blind Spot Monitoring (BSM)
- Distance & Speed Alert (DSA)
- Front Cross Traffic Alert (FCTA)
- Rear Cross Traffic Alert (RCTA)
- Lane-keep Assist System (LAS)

NOTE

The status of the system turned on using the personalisation feature is displayed.

**i-ACTIVSENSE status symbol
(warning/risk avoidance support
system) (white)****System stand-by status**

If none of the systems are activated or if there is a problem with the system, the i-ACTIVSENSE status symbol (warning/risk avoidance support system) (white) is displayed.

NOTE

For example, even when the Blind Spot Monitoring (BSM) is operating normally, if the Lane Departure Warning System (LDWS) has a problem, the i-ACTIVSENSE status symbol (warning/risk avoidance support system) (white) is displayed.

**i-ACTIVSENSE status symbol
(warning/risk avoidance support
system) (green)****System activated status**

If any one of the systems is activated, the i-ACTIVSENSE status symbol (warning/risk avoidance support system) (green) is displayed.

NOTE

Even if the i-ACTIVSENSE status symbol (warning/risk avoidance support system) (green) is displayed, systems which do not meet the operation conditions will not operate.

**i-ACTIVSENSE status symbol
(warning/risk avoidance support
system) (amber)****System warning status**

If any system warning is activated, the i-ACTIVSENSE status symbol (warning/risk avoidance support system) (amber) is displayed.

**i-ACTIVSENSE status symbol
(warning/risk avoidance support
system) (non-display)****System OFF status**

When all systems are switched off using the personalisation feature or the i-ACTIVSENSE switch, the i-ACTIVSENSE status symbol (warning/risk avoidance support system) does not display.

▼ i-ACTIVSENSE Switch

The operation status of all of the following systems can be changed by operating the i-ACTIVSENSE switch.

- Lane Departure Warning System (LDWS)
- Blind Spot Monitoring (BSM)
- Distance & Speed Alert (DSA)
- Front Cross Traffic Alert (FCTA)

i-ACTIVSENSE

- Rear Cross Traffic Alert (RCTA)
- Lane-keep Assist System (LAS)
- Smart Brake Support (SBS)
- Smart Brake Support [Rear] (SBS-R)
- Smart Brake Support [Rear Crossing] (SBS-RC)



NOTE

- For the systems which can be cancelled using the i-ACTIVSENSE switch, they cannot be cancelled when the following systems are operating, even if you press the i-ACTIVSENSE switch.
 - Mazda Radar Cruise Control (MRCC)
 - Mazda Radar Cruise Control with Stop & Go function (MRCC with Stop & Go function)
 - Cruising & Traffic Support (CTS)
- If you switch the ignition OFF while you have cancelled some or all of the systems using the i-ACTIVSENSE switch, the operational status of each system will vary when the ignition ON is switched again.
 - **Systems which maintain their status before the ignition is switched OFF**
 - Lane Departure Warning System (LDWS)
 - Blind Spot Monitoring (BSM)
 - Distance & Speed Alert (DSA)

4-86

- Front Cross Traffic Alert (FCTA)
- Rear Cross Traffic Alert (RCTA)
- Lane-keep Assist System (LAS)

Systems which are restored to operational status automatically

- Smart Brake Support (SBS)
- Smart Brake Support [Rear] (SBS-R)
- Smart Brake Support [Rear Crossing] (SBS-RC)
- If a system is cancelled using the personalisation feature, the system remains cancelled even if the i-ACTIVSENSE switch is pressed.

The systems which can be cancelled vary depending on whether the i-ACTIVSENSE switch is short or long-pressed.

When the i-ACTIVSENSE switch is pressed and released immediately

When pressing and immediately releasing the i-ACTIVSENSE switch, the following systems are cancelled and the i-ACTIVSENSE status symbol (warning/risk avoidance support system) turns off.

- Lane Departure Warning System (LDWS)
- Blind Spot Monitoring (BSM)
- Distance & Speed Alert (DSA)
- Front Cross Traffic Alert (FCTA)
- Rear Cross Traffic Alert (RCTA)
- Lane-keep Assist System (LAS)

If the i-ACTIVSENSE switch is pressed again, the systems return to their original status, and the i-ACTIVSENSE status symbol (warning/risk avoidance support system) turns on.

NOTE

You can select systems you want to cancel using the personalisation features. Refer to the Settings section in the MZD Connect Owner's Manual.

When the i-ACTIVSENSE switch is pressed and held

When pressing and holding the i-ACTIVSENSE switch, the following systems are cancelled in addition to the systems which are cancelled by pressing and immediately releasing the switch. The i-ACTIVSENSE status symbol (warning/risk avoidance support system) turns off and the SBS OFF indicator light turn on.

- Smart Brake Support (SBS)
- Smart Brake Support [Rear] (SBS-R)
- Smart Brake Support [Rear Crossing] (SBS-RC)



If the i-ACTIVSENSE switch is pressed again, the systems return to their original status, the SBS OFF indicator light turns off and the i-ACTIVSENSE status symbol (warning/risk avoidance support system) turns on.

High Beam Control System (HBC)*

▼ High Beam Control System (HBC)

The HBC determines the conditions in front of the vehicle using the Forward Sensing Camera (FSC) while driving in darkness to automatically switch the headlights between high and low beams. Refer to Forward Sensing Camera (FSC) on page 4-206.

While driving the vehicle at a speed of about 30 km/h (19 mph) or more, the headlights are switched to high beams when there are no vehicles ahead or approaching in the opposite direction. The system switches the headlights to low beams when one of the following occurs:

- The system detects a vehicle or the headlights/lights of a vehicle approaching in the opposite direction.
- The vehicle is driven on roads lined with streetlamps or on roads in well-lit cities and towns.
- The vehicle is driven at less than about 20 km/h (12 mph).

i-ACTIVSENSE

- The headlight high-beam indicator light turns on while the high beams are on.

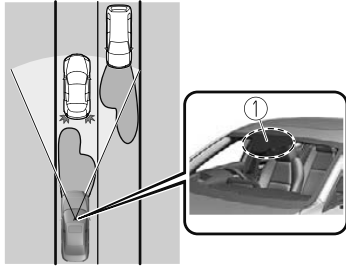

1. Forward Sensing Camera (FSC)*1

*1 The recognition distance of the Forward Sensing Camera (FSC) varies according to the surrounding conditions.

The warning light turns on when the system has a malfunction.

Refer to High Beam Control System (HBC) Warning Indication/Warning Light (Amber) on page 7-30.

CAUTION

- Do not adjust the vehicle height, modify the headlight units, or remove the camera, otherwise the system will not operate normally.
- Do not rely excessively on the HBC and drive the vehicle while paying sufficient attention to safety. Switch the headlights between the high beams and low beams manually if necessary.

NOTE

The timing in which the system switches the headlights changes under the following conditions. If the system does not switch the headlights appropriately, manually switch between high and low beams according to the visibility as well as road and traffic conditions.

- When there are sources of light in the area such as street lamps, illuminated signboards, and traffic signals.
- When there are reflective objects in the surrounding area such as reflective plates and signs.
- When visibility is reduced under rain, snow and foggy conditions.
- When driving on roads with sharp turn or hilly terrain.
- When the headlights/rear lamps of vehicles in front of you or in the opposite lane are dim or not illuminated.
- When there is insufficient darkness such as at dawn or dusk.
- When the luggage compartment is loaded with heavy objects or the rear passenger seats are occupied.
- When visibility is reduced due to a vehicle in front of you spraying water from its tyres onto your windscreen.

▼ To Operate the System

The HBC operates to switch the headlights automatically between high and low beams after the ignition is switched ON and the headlight switch is in the AUTO and low beam position.

The HBC determines that it is dark based on the brightness of the surrounding area. At the same time, the HBC indicator light (green) in the instrument cluster illuminates.



NOTE

*Operation of the HBC function can be disabled.
Refer to the Settings section in the MZD Connect Owner's Manual.*

▼ Manual Switching

Switching to low beams

Switch the headlight switch to the  position, or press the high beam control switch.

The HBC indicator light (green) turns off.

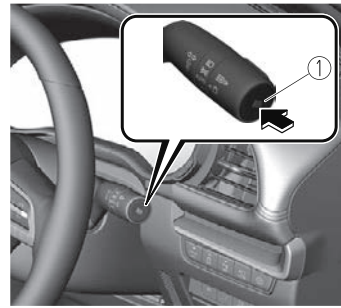

1. High beam control switch

If the HBC is turned off using the high beam control switch, press the high beam control switch again to turn the HBC back on.

Switching to high beams

Shift the lever to the high beam position. The HBC indicator light (green) turns off and the headlight high-beam indicator light is illuminated.

Adaptive LED Headlights (ALH)*

▼ Adaptive LED Headlights (ALH)

The ALH are a system which uses the Forward Sensing Camera (FSC) to determine the situation of a vehicle ahead or a vehicle approaching in the opposite direction while driving at night to automatically switch the illumination range of the headlights, the illuminated area, or the illumination brightness. Refer to Forward Sensing Camera (FSC) on page 4-206.

The ALH are controlled between high and low beams as follows to assure the driver's visibility without dazzling a vehicle ahead or a vehicle approaching in the opposite direction.

Glare-Free High Beam

This feature dims only the high-beam light shone on the vehicle ahead.

The high beams will dim while driving at a speed of about 40 km/h (25 mph) or faster. When the vehicle speed is less than about 30 km/h (19 mph), the beams switch to the low beams.

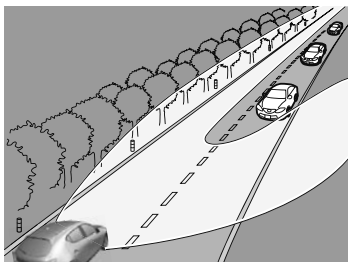

NOTE

The headlight high-beam indicator light turns on while the high beams are on.

4-90

*Some models.

Wide-Range Low Beam

This feature extends the illumination range of the light cast by the low beams while driving at a speed less than about 40 km/h (25 mph).

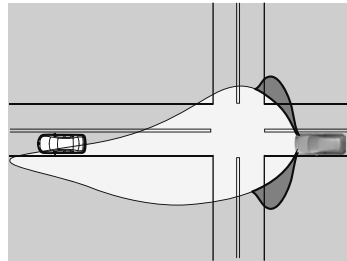

Highway Mode

This feature shifts the illumination angle of the light cast by the headlights upward while driving on highways.

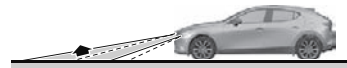

The distance in which the ALH can detect objects varies depending on the surrounding conditions.

CAUTION

- Do not modify the suspensions or headlight units, or remove the camera. Otherwise, the ALH may not operate normally.
- Do not rely excessively on the ALH and drive the vehicle while paying sufficient attention to safety. Switch the headlights between the high beams and low beams manually if necessary.

NOTE

Under the following conditions, the ALH may not operate normally. Manually switch between the high and low beams according to the visibility, and the road and traffic conditions.

- *When there are other sources of light in the area such as street lamps, illuminated signboards, and traffic signals.*
- *When there are reflective objects in the surrounding area such as reflective plates and signs.*
- *When visibility is reduced under rain, snow and foggy conditions.*
- *When driving on roads with sharp curves or undulations.*
- *When the headlights/rear lamps of vehicles ahead or in the opposite lane are dim or not illuminated.*
- *When there is insufficient darkness such as at dawn or dusk.*
- *When the luggage compartment is loaded with heavy objects or the rear passenger seats are occupied.*
- *When visibility is reduced due to a vehicle ahead spraying water from its tyres onto your windscreen.*

▼ **To Operate the System**

The ALH operates to control Glare-Free High Beam, Wide-Range Low Beam and Highway Mode automatically after the ignition is switched ON and the headlight switch is in the **AUTO** and low beam position.

The ALH determines that it is dark based on the brightness of the surrounding area. At the same time, the ALH indicator light (green) in the instrument cluster illuminates.



NOTE

Operation of the ALH function can be disabled. Refer to the Settings section in the MZD Connect Owner's Manual.

▼ Manual Switching

Switching to low beams

Switch the headlight switch to the  position, or press the Adaptive LED headlights switch.

The ALH indicator light (green) turns off.

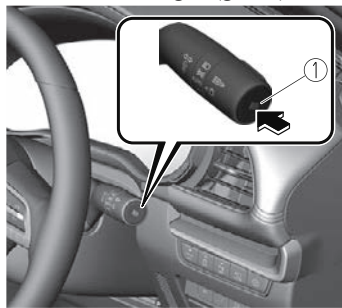

1. Adaptive LED headlights switch

If the ALH is turned off using the Adaptive LED headlights switch, press the Adaptive LED headlights switch again to turn the ALH back on.

Switching to high beams

Shift the lever to the high beam position. The ALH indicator light (green) turns off and the headlight high-beam indicator light is illuminated.

Lane Departure Warning System (LDWS)

▼ Lane Departure Warning System (LDWS)

The LDWS alerts the driver that the vehicle may be deviating from its lane. If the white (yellow) lines on the traffic lane are detected using the Forward Sensing Camera (FSC) and the system determines that the vehicle may be deviating from its lane, it notifies the driver by activating the LDWS warning beep and by the multi-information display.

Refer to Forward Sensing Camera (FSC) on page 4-206.

Use the LDWS when you drive the vehicle on roads with white (yellow) lines.

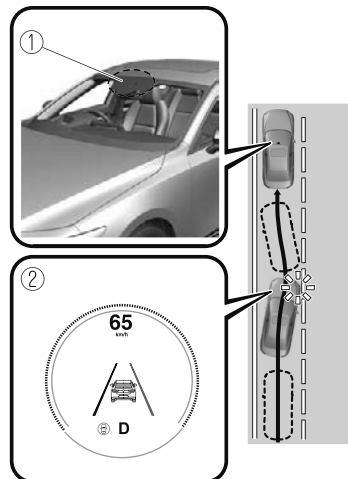

1. Forward sensing camera (FSC)
2. Multi-information display

! WARNING**Do not rely completely on the LDWS:**

- The LDWS system is not designed to compensate for a driver's lack of caution and relying too much on the system could lead to an accident.
- The functions of the LDWS have limitations. Always stay on course using the steering wheel and drive with care.
- Do not use the LDWS under the following circumstances, otherwise it may result in an accident.
 - The vehicle is driven on slippery roads such as icy or snow-covered roads, and unpaved roads.
 - Tyres of a different specified size are used, such as a temporary spare tyre.
 - Tyres with insufficient tread are used.
 - The tyre pressures are not adjusted to the specified pressure.
 - The vehicle is being used to tow a camper or boat trailer.
 - Tyre chains are used.
 - The vehicle is driven on roads with lane lines other than white (yellow) lines, such as an expressway.

! CAUTION

Heed the following cautions so that the LDWS can operate normally.

- Do not modify the vehicle's suspensions.
- Always use wheels of the specified type and size for the front and rear wheels. Consult an expert repairer, we recommend an Authorised Mazda Repairer for tyre replacement.

NOTE

The system may not operate normally under the following conditions.

- The white (yellow) lane lines are less visible because of dirt or paint flaking.
- White (yellow) lane lines are less visible because of bad weather (rain, fog, or snow).
- The vehicle is driven on a temporary lane or section with a closed lane resulting from construction where there might be multiple white (yellow) lane lines, or they are interrupted.
- The camera picks up an obscure line, such as a temporary line being used for construction, or because of shade, unmelted snow, or grooves filled with water.
- The surrounding brightness suddenly changes such as when entering or exiting a tunnel.
- Back-light is reflected off the road surface.
- The road surface is wet and shiny after rain, or there are puddles on the road.
- The width of a lane is excessively narrow.
- The vehicle is driven on roads with tight curves.
- Heavy luggage is loaded in the luggage compartment or on the rear seat causing the vehicle to tilt.
- The vehicle is driven through a fork in the road or a junction.
- The shade of a guardrail parallel to a white (yellow) lane line is cast on the road.
- The illumination of the headlights is weakened because of dirt or the optical axis is deviated at night.
- The road is excessively uneven.

i-ACTIVSENSE

- The vehicle is shaken after hitting a road bump.
- A vehicle in front of your vehicle is running near a white (yellow) lane line making it less visible.
- The windscreen is dirty or foggy.
- Strong light is directed from the front of the vehicle (such as sunlight, or headlights (high-beam) of on-coming vehicles).
- The vehicle is driven through an intersection or a roundabout.

▼ When the System Operates

When the ignition is switched ON, the i-ACTIVSENSE status symbol (warning/risk avoidance support system) (white) turns on and the system goes on standby.



NOTE

If the i-ACTIVSENSE status symbol (warning/risk avoidance support system) (white) does not turn on, the system is cancelled using the i-ACTIVSENSE switch or the personalisation feature.

Operation conditions

When all of the following conditions are met, the i-ACTIVSENSE status symbol (warning/risk avoidance support system) on the multi-information display changes from white to green and the system becomes operational.

- The ignition is switched ON.
- The vehicle speed is about 60 km/h (37 mph) or faster.

- The system detects white (yellow) lane lines.



NOTE

When the system does not detect a white (yellow) lane line on one side only, the system does not operate on the side that is not being detected.

When temporarily cancelling the system

The LDWS becomes operational in the following cases: The LDWS operation is automatically restored when the system's operation conditions are met.

- The system cannot detect white (yellow) lane lines.
- The vehicle speed is less than about 55 km/h (34 mph).
- The direction indicator lever is operated.
- The accelerator pedal is depressed.
- The TCS/DSC is operating.
- The steering wheel is operated.
- The brake pedal is operated.

The function is temporarily stopped.

The LDWS stops functioning in the following cases:

- The temperature in the forward sensing camera (FSC) is high or low.
- The windscreen around the forward sensing camera (FSC) is foggy.
- The windscreen around the forward sensing camera (FSC) is blocked by an obstruction, causing poor forward visibility.

- Strong light (such as sunlight, or headlights (high-beam) of on-coming vehicles) is directed at the forward sensing camera (FSC).

System malfunction

If there is a problem with the system, the i-ACTIVSENSE status symbol (warning/risk avoidance support system) (white) and the i-ACTIVSENSE warning indication/warning light on the multi-information display turns on and a message is indicated.

Refer to i-ACTIVSENSE Status Symbol (Warning/Risk Avoidance Support System) on page 4-84.

▼ Lane Departure Warning

If the system determines that the vehicle may deviate from its lane, a warning (beep sound, steering wheel vibration) is activated and the direction in which the system determines that the vehicle may deviate is indicated on the multi-information display.

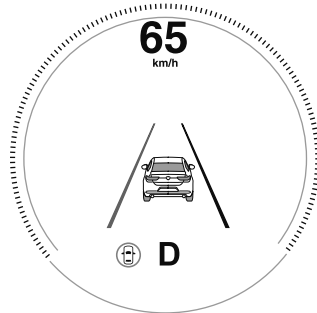

NOTE

- The LDWS settings can be changed. Refer to the Settings section in the MZD Connect Owner's Manual.

- You may not be able to hear the LDWS warning sound depending on the surrounding conditions such as outside noise.
- If you set the LDWS to vibrate the steering wheel, you may not feel the vibrations depending on the road surface conditions.

▼ Cancelling the System

The LDWS can be set to inoperable.

- **(If only the LDWS is turned off)**
Refer to the Settings section in the MZD Connect Owner's Manual.
- **(If the LDWS is turned off by operating the i-ACTIVSENSE switch)**
Refer to i-ACTIVSENSE Switch on page 4-85.

NOTE

When the ignition is switched OFF, the system status before it was turned off is maintained. For example, if the ignition is switched OFF with the LDWS operable, the LDWS remains operational the next time the ignition is switched ON.

Blind Spot Monitoring (BSM)

▼ Blind Spot Monitoring (BSM)

The BSM is designed to assist the driver in checking the area to the rear of the vehicle on both sides during lane changes by notifying the driver of the presence of vehicles approaching from the rear in an adjacent lane.

BSM operation

The BSM detects vehicles approaching from the rear while travelling in the forward direction at a speed of 10 km/h (6.3 mph) or faster and notifies the driver by turning on the BSM warning indicator light and displaying the vehicle detection screen.

If the direction indicator lever is operated to signal a turn in the direction in which the BSM warning indicator light is illuminated while the approaching vehicle is detected, the BSM notifies the driver of possible danger flashing on the BSM warning indicator light, and by activating the warning sound and the warning screen indicator display.

The detection area on this system covers the driving lanes on both sides of the vehicle and from the rear part of the front doors to about 50 m (164 ft) behind the vehicle.

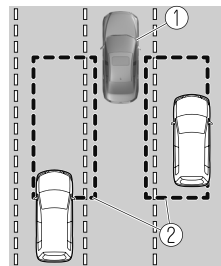

1. Your vehicle
2. Detection areas

⚠ WARNING

Always check the surrounding area visually before making an actual lane change:

The system is only designed to assist you in checking for vehicles at your rear when making a lane change. Due to certain limitations with the operation of this system, the BSM warning indicator light, the warning sound and the warning screen indicator display may not activate or they might be delayed even though a vehicle is in an adjacent driving lane. Always make it your responsibility as a driver to check the rear.

NOTE

- The BSM will operate when all of the following conditions are met:
 - The ignition is switched ON.
 - The i-ACTIVSENSE warning indication/warning light in the instrument cluster is turned off.
 - The vehicle speed is about 10 km/h (6.3 mph) or faster.
- The BSM will not operate under the following circumstances.
 - The vehicle speed falls below about 8 km/h (5 mph) even though the i-ACTIVSENSE warning indication/warning light is turned off.
 - The shift lever (manual transmission)/selector lever (automatic transmission) is shifted to reverse (R) and the vehicle is reversing.
 - The turning radius is small (making a sharp turn, turning at intersections).
- In the following cases, the i-ACTIVSENSE warning indication/warning light turns on and operation of the system is stopped. If the i-ACTIVSENSE warning indication/warning light remains illuminated, have the vehicle inspected at an expert repairer; we recommend an Authorised Mazda Repairer as soon as possible.
 - Some problem with the system including the BSM warning indicator lights is detected.
 - A large deviation in the installation position of a rear side radar sensor on the vehicle has occurred.
 - There is a large accumulation of snow or ice on the rear bumper near a rear side radar sensor. Remove any snow, ice or mud on the rear bumper.
- Driving on snow-covered roads for long periods.
- The temperature near the rear side radar sensor becomes extremely hot due to driving for long periods on slopes during the summer.
- The battery voltage has decreased.
- Under the following conditions, the rear side radar sensor cannot detect target objects or it may be difficult to detect them.
 - The rear bumper around the rear side radar sensor is deformed.
 - Radio wave interference from a radar sensor equipped on a nearby vehicle.
 - The approaching vehicle is any of the following shapes.
 - a) The size of the vehicle body is extremely small.
 - b) The vehicle height is extremely low or high.
 - c) A special type of vehicle with a complex shape.
 - A vehicle is in the detection area at the rear in an adjacent driving lane but it does not approach. The BSM determines the condition based on radar detection data.
 - A vehicle is travelling alongside your vehicle at nearly the same speed for an extended period of time.
 - Vehicles approaching in the opposite direction.
 - A vehicle in an adjacent driving lane is attempting to pass your vehicle.
 - A vehicle is in an adjacent lane on a road with extremely wide driving lanes. The detection area of the rear side radar sensor is set at the road width of expressways.

i-ACTIVSENSE

· In the following case, the flashing of the BSM warning indicator light, and the activation of the warning sound and the warning screen indicator display may not occur or they may be delayed.

- A vehicle makes a lane change from a driving lane two lanes over to an adjacent lane.
- Driving on steep slopes.
- Crossing the summit of a hill or mountain pass.
- When there is a difference in the height between your driving lane and the adjacent lane.
- Directly after the BSM system becomes operable by changing the setting.
- If the road width is extremely narrow, vehicles two lanes over may be detected. The detection area of the rear side radar sensor is set according to the road width of expressways.
- The BSM warning indicator light may turn on and the vehicle detection screen may be displayed in the display in reaction to stationary objects (guardrails, tunnels, sidewalls, and parked vehicles) on the road or the roadside.

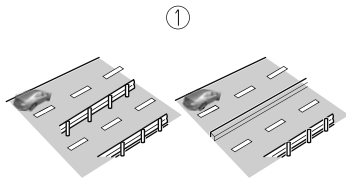

1. Objects such as guardrails and concrete walls running alongside the vehicle.

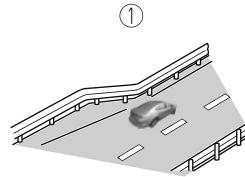

1. Places where the width between guardrails or walls on each side of the vehicle narrows.

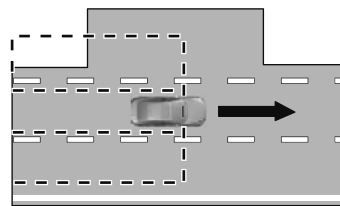
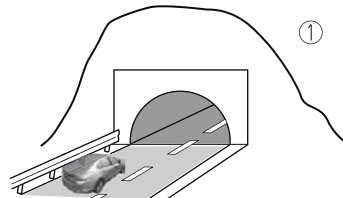

1. The walls at the entrance and exits of tunnels, turnouts.

· A BSM warning indicator light may flash or the warning beep may be activated several times when making a turn at a city intersection.

- Turn off the BSM while pulling a trailer or while an accessory such as a bicycle carrier is installed to the rear of the vehicle. Otherwise, the radar's radio waves will be blocked causing the system to not operate normally.
- If a Mazda genuine trailer hitch is used, the BSM is automatically turned off.
- In the following cases, it may be difficult to view the illumination/flashing of the BSM warning indicator lights equipped on the door mirrors.
 - Snow or ice is adhering to the door mirrors.
 - The front door glass is fogged or covered in snow, frost or dirt.
- The rear side radar sensor of the BSM may be regulated under the radio wave related laws of the country where the vehicle is driven. If this system is used abroad, it may be necessary to turn off the system.
Refer to Rear Side Radar Sensor on page 4-214.
- The system switches to the Rear Cross Traffic Alert (RCTA) function when the shift lever (manual transmission) or the selector lever (automatic transmission) is shifted to the reverse (R) position.
Refer to Rear Cross Traffic Alert (RCTA) on page 4-116.

▼ **Blind Spot Monitoring (BSM)
Warning Indicator Lights/Display
Indicator/Blind Spot Monitoring
(BSM) Warning Beep**

The BSM system notifies the driver of the presence of vehicles in adjacent lanes or at the rear of the vehicle using the BSM warning indicator light, the warning sound and the display indicator while the systems are operational.

BSM warning indicator lights

The BSM warning indicator lights are equipped on the left and right door mirrors. The warning indicator lights turn on when a vehicle approaching from the rear in an adjacent lane is detected.

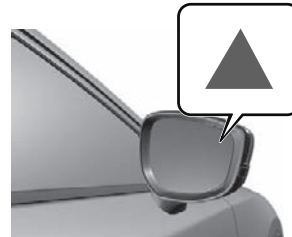

When the ignition is switched ON, the warning indicator light turns on momentarily and then turns off after a few seconds.

i-ACTIVSENSE

Function for cancelling illumination dimmer

If the BSM warning indicator lights turn on when the position lights are turned on, the brightness of the BSM warning indicator lights is dimmed.

If the BSM warning indicator lights are difficult to see due to glare from surrounding brightness when travelling on snow-covered roads or under foggy conditions, press the dimmer cancellation button to cancel the dimmer and increase the brightness of BSM warning indicator lights when they turn on.

Refer to Instrument Panel Illumination on page 4-25.

Display indicator

The detected approaching vehicle and warning are displayed in the multi-information display and active driving display (vehicles with active driving display).

Multi-information Display

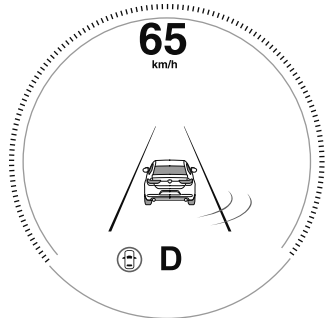

Active Driving Display (vehicles with active driving display)

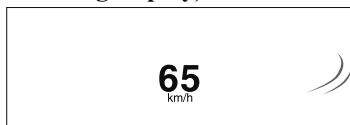

4-100

The detected direction is displayed with a detection indicator (white) when an approaching vehicle is detected. In addition, if the direction indicator lever is operated to signal a lane change while the vehicle is detected, the display changes the colour (amber) of the warning indicator.

BSM warning beep

The BSM warning beep is activated simultaneously with the flashing of a BSM warning indicator light.

▼ Cancelling Operation of Blind Spot Monitoring (BSM)

The BSM system can be set to inoperable.

- **(If only the BSM is turned off)**
Refer to the Settings section in the MZD Connect Owner's Manual.
- **(If the BSM is turned off by operating the i-ACTIVSENSE switch)**
Refer to i-ACTIVSENSE Switch on page 4-85.

NOTE

When the ignition is switched OFF, the system status before it was turned off is maintained. For example, if the ignition is switched OFF while the BSM systems are operational, the BSM systems remain operational the next time the ignition is switched ON.

Traffic Sign Recognition System (TSR)

▼ Traffic Sign Recognition System (TSR)

The TSR helps prevent the driver from overlooking traffic signs, and provides support for safer driving by displaying traffic signs on the active driving display/instrument cluster which are recognised by the Forward Sensing Camera (FSC) or recorded in the navigation system while the vehicle is driven.

The TSR displays the speed limit (including auxiliary signs), do not enter, and traffic stop signs.

If the vehicle speed exceeds the speed limit sign indicated in the active driving display/instrument cluster while the vehicle is driven, the system notifies the driver using the indication in the active driving display/instrument cluster and a warning sound.

Speed limit (including auxiliary signs) and do not enter signs

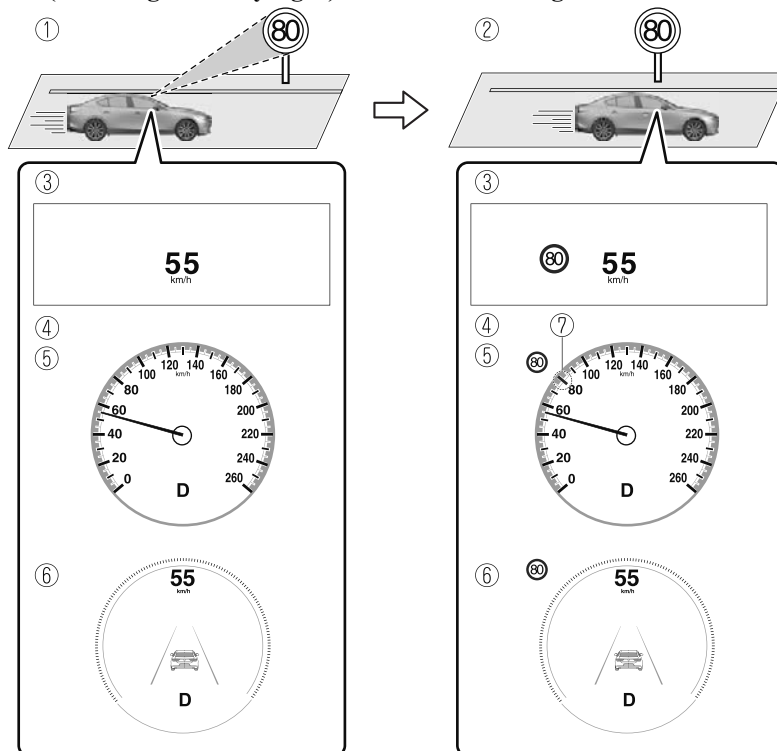

1. Sign recognised
2. Sign displayed
3. Active driving display indication

When Driving

i-ACTIVSENSE

4. Instrument cluster
5. Basic display
6. i-ACTIVSENSE display
7. Recognized speed limit indication colour changes.

Stop sign

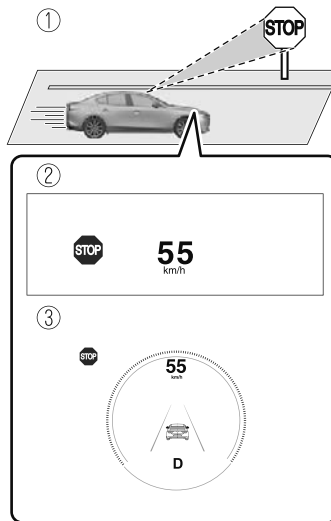

1. Sign recognised and displayed at same time
2. Active driving display indication
3. Instrument cluster

WARNING

Always check the traffic signs visually while driving.

The TSR helps prevent the driver from overlooking traffic signs and provides support for safer driving. Depending on the weather conditions or problems with traffic signs, a traffic sign may not be recognised or a traffic sign different from the actual traffic sign may be displayed. Always make it your responsibility as a driver to check the actual traffic signs. Otherwise, it could result in an accident.

NOTE

- The TSR is not supported in some countries or regions. For information concerning the supported countries or regions, consult an expert repairer, we recommend an Authorised Mazda Repairer.

4-102

- *The TSR operates only if the navigation system SD card (Mazda genuine) is inserted in the SD card slot. Consult an expert repairer, we recommend an Authorised Mazda Repairer for details.*
- *The TSR does not operate if there is a malfunction in the Forward Sensing Camera (FSC).*
- *Under the following conditions, the TSR may not operate normally.*
 - *An object placed on the instrument panel is reflected in the windscreen and picked up by the camera.*
 - *Heavy luggage is loaded in the luggage compartment or on the rear seat and the vehicle is tilted.*
 - *The tyre pressures are not adjusted to the specified pressure.*
 - *Tyres other than standard tyres are equipped.*
 - *The vehicle is driven on the ramp and surrounding area to or from a rest area or a tollgate on a highway.*
 - *When surrounding brightness suddenly changes such as when entering or exiting a tunnel.*
 - *The illumination of the headlights is weakened because of dirt or the optical axis is deviated.*
 - *The windscreen is dirty or foggy.*
 - *The windscreen and camera are fogged (water droplets).*
 - *Strong light is directed at the front of the vehicle (such as backlight or high-beam headlights of on-coming vehicles).*
 - *The vehicle is making a sharp turn.*
 - *Strong light reflects off the road.*
 - *A traffic sign is in a position which makes it difficult to reflect the light from the vehicle's headlights, such as when the vehicle is driven at night or in a tunnel.*
 - *The vehicle is driven under weather conditions such as rain, fog, or snow.*
 - *The stored map data for the navigation system is not current.*
 - *A traffic sign is obscured by mud or snow.*
 - *A traffic sign is concealed by trees or a vehicle.*
 - *A traffic sign is partially shaded.*
 - *A traffic sign is bent or warped.*
 - *A traffic sign is too low or too high.*
 - *A traffic sign is too bright or too dark (including electronic traffic signs).*
 - *A traffic sign is too big or too small.*
 - *There is an object similar to the traffic sign being read (such as another traffic sign or other signs resembling it).*
- *The TSR can be set to invisible on the active driving display.
Refer to the Settings section in the MZD Connect Owner's Manual.*

▼ **Traffic Sign Display Indication**

The following traffic signs are displayed on the active driving display/instrument cluster.

Speed limit signs (including auxiliary signs)

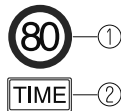

1. Speed limit signs
2. Auxiliary sign (example)

If the Forward Sensing Camera (FSC) cannot classify an auxiliary sign (such as time restrictions, turning restrictions, end of section) correctly, the following screen is displayed.



Do not enter signs



Stop signs



NOTE

Speed limit signs (including auxiliary signs)

- When the vehicle speed is about 1 km/h (0.6 mph) or faster, the speed limit sign is displayed when any one of the following conditions are met.
- The Forward Sensing Camera (FSC) recognises a speed limit sign as a sign targeted for your vehicle and the vehicle passes it.

- The speed limit sign stored in the navigation system is read.
- In the following cases, display of the speed limit sign stops.
 - Each sensor determines that the vehicle has changed direction of travel.
 - The Forward Sensing Camera (FSC) recognises a new speed limit sign which differs from the previous one (displays the new speed limit sign).
 - The speed limit sign stored in the navigation system is not read within a certain period of time (if the Forward Sensing Camera (FSC) does not recognise a speed limit sign, the speed limit sign stored in the navigation system is displayed).
 - The vehicle speed exceeds the displayed speed limit sign by 30 km/h (19 mph) or more after a certain period of time has elapsed since the speed limit sign was displayed. (Except when there is information for the speed limit sign in the navigation system)

Do not enter signs

- A do not enter sign is displayed when all of the following conditions are met.
 - The vehicle speed is about 80 km/h (50 mph) or slower.
 - The Forward Sensing Camera (FSC) recognises a do not enter sign as a sign targeted for your vehicle and the vehicle passes it.
- When the Forward Sensing Camera (FSC) recognises the do not enter sign and a certain period of time has elapsed since the vehicle passed the sign, display of the do not enter sign stops.

Stop sign

- *A stop sign is displayed when all of the following conditions are met:*
 - *The vehicle speed is about 40 km/h (25 mph) or slower.*
 - *The Forward Sensing Camera (FSC) recognises a stop sign as a sign targeted for your vehicle.*
 - *When a certain period of time has elapsed since the stop sign was displayed, display of the stop sign stops.*

▼ Excessive Speed Warning

If the vehicle speed exceeds the speed limit sign displayed in the active driving display/instrument cluster, the area around the speed limit sign flashes in amber and the warning sound is activated at the same time. If the vehicle speed continues to exceed the displayed speed limit sign, the indication stops flashing and remains on. Check the surrounding conditions and adjust the vehicle speed to the legal speed using the appropriate operation such as depressing the brake pedal.

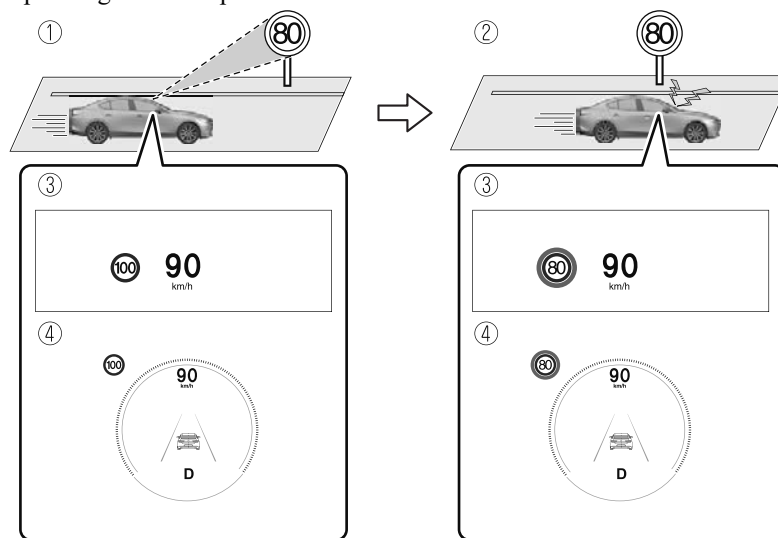

1. Vehicle is doing 90 km/h when 80 km/h speed limit sign is recognised.
2. Vehicle continues to do 90 km/h after 80 km/h speed limit sign is passed.
3. Active driving display indication
4. Instrument cluster

The excessive speed warning is initially set to visual only. If you want to activate the excessive speed warning, change the setting in the personalisation features. In addition, the warning pattern and the warning activation timing differ depending on the setting contents. Refer to the Settings section in the MZD Connect Owner's Manual.

Speed Limit Sign Alert setting

- Off: The excessive speed warning is not activated.
- Visual: The area around the speed limit sign displayed in the display flashes in amber, and if the vehicle speed continues to exceed the displayed speed limit sign, the indication stops flashing and remains on.

- **Visual + Audible:** The area around the speed limit sign displayed in the display flashes in amber and the warning sound is activated at the same time. If the vehicle speed continues to exceed the displayed speed limit sign, the indication stops flashing and remains on. The warning sound is activated continuously until the vehicle speed decreases below the speed limit sign.

Speed Limit Sign Threshold setting

- + 0: If the vehicle speed exceeds the speed limit sign displayed in the display, the excessive speed warning is activated.
- + 5: If the vehicle speed exceeds the speed limit sign displayed in the display by 5 km/h (3 mph), the excessive speed warning is activated.
- + 10: If the vehicle speed exceeds the speed limit sign displayed in the display by 10 km/h (5 mph), the excessive speed warning is activated.

NOTE

- *In the following cases, the excessive speed warning stops operating.*
 - *The vehicle speed is less than the speed of the displayed speed limit sign. (If the activation timing for the excessive speed warning is changed in the personalisation features, the excessive speed warning stops operating when the vehicle speed is less than the changed vehicle speed.*
 - *A speed limit sign indication has been updated and the vehicle speed is lower than the updated indication.*
 - *Display of the speed limit sign stops.*
- *The warning indication is displayed at the same time the excessive speed warning sound is activated if the vehicle speed exceeds the speed indicated on the speed limit sign. Refer to Excessive Speed Warning on page 7-41.*
- *If the Forward Sensing Camera (FSC) or data recorded in the navigation system incorrectly recognises the actual speed limit sign at a lower speed, the excessive speed alarm is activated even if the vehicle is driven at the legal speed.*

Distance & Speed Alert (DSA)

▼ Distance & Speed Alert (DSA)

The DSA is a system which provides advice for maintaining the appropriate distance between vehicles and notifies the driver of the recommended, safe distance to maintain with a vehicle ahead. The system measures the distance between your vehicle and a vehicle ahead while the vehicle speed is about 30 km/h (19 mph) or faster. If the distance between your vehicle and the vehicle ahead is continuously close, the system alerts the driver of a possible collision using an indication on the display and suppresses your vehicle speed to prevent it from approaching the vehicle ahead too closely.

WARNING

Do not rely completely on the DSA:

The ability of the system to detect a vehicle ahead is limited depending on the type of vehicle ahead, weather conditions, or traffic conditions. In addition, the system is not for maintaining the distance between your vehicle and a vehicle ahead. If you neglect to operate the accelerator and brake pedals correctly, it could lead to an accident. Always check the safety of the surrounding area and depress the brake pedal or accelerator pedal while keeping a safe distance from vehicles ahead or on-coming vehicles.

Operation conditions

The DSA operates when the following conditions are all met.

- The ignition is switched ON.
- The DSA is turned on.
- The shift lever (manual transmission vehicle) or the selector lever (automatic transmission vehicle) is in a position other than R.
- The vehicle speed is about 30 km/h (19 mph) or faster.
- i-ACTIVSENSE status symbol (warning/risk avoidance support system) (green) is displayed.

NOTE

- *The objects which activate the system are four-wheeled vehicles.*
- *The DSA may also operate in the presence of motorcycles and bicycles.*
- *The DSA may not operate normally when the speed of a vehicle ahead is too slow.*
- *The system does not operate with the following objects.*
 - *Vehicles approaching in the opposite direction.*
 - *Stationary objects (stopped vehicles, obstructions)*
- *The DSA can be set to inoperable.*
 - **(If only the DSA is turned off)**
Refer to the Settings section in the MZD Connect Owner's Manual.
 - **(If the DSA is turned off by operating the i-ACTIVSENSE switch)**
Refer to i-ACTIVSENSE Switch on page 4-85.
- *When the ignition is switched OFF, the system status before it was turned off is maintained. For example, if the ignition is switched OFF with the DSA operable, the system will be operable when the ignition is switched ON the next time.*

▼ **Vehicle Ahead Close Proximity Warning**

When the system determines that the distance between your vehicle and a vehicle ahead is close, the i-ACTIVSENSE status symbol (warning/risk avoidance support system) changes from green to amber and the warning indication is displayed on the multi-information display. While checking the safety of the surrounding area, depress the brake pedal while keeping a safe distance from the vehicle ahead.

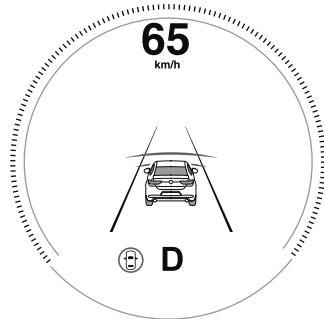

Driver Attention Alert (DAA)

▼ **Driver Attention Alert (DAA)**

The DAA is a system which detects driver fatigue and decreased attentiveness, and encourages the driver to take a rest.

When the vehicle is driven inside traffic lane lines at about 65 to 140 km/h (41 to 86 mph), the DAA estimates the amount of accumulated fatigue and decreased attentiveness of the driver based on the information from the Forward Sensing Camera (FSC) and other vehicle information, and encourages the driver to take a rest using an indication on the multi-information display and a warning sound.

Use the DAA on expressways or highways.

Refer to Forward Sensing Camera (FSC) on page 4-206.

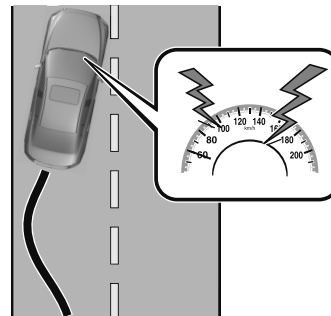

⚠ WARNING

Do not rely completely on DAA and always drive carefully:

The DAA detects driver fatigue and decreased attentiveness and encourages the driver to take a rest, however, it is not designed to prevent the vehicle from straying. If you rely too much on the DAA it could lead to an accident. Drive carefully and operate the steering wheel appropriately.

In addition, the system may not be able to detect driver fatigue and decreased attentiveness correctly depending on the traffic and driving conditions. The driver must take sufficient rest in order to drive safely.

NOTE

- The DAA operates when all of the following conditions are met.
 - The vehicle speed is about 65 to 140 km/h (41 to 86 mph).
 - The system detects white (yellow) lane lines.
 - The system has completed learning of the driver's driving data after 60 minutes have passed since the driver began driving vehicle.
- The DAA does not operate under the following conditions.
 - The vehicle speed is less than about 65 km/h (41 mph).
 - The vehicle speed exceeds about 140 km/h (86 mph)
 - The vehicle is making a sharp turn.
 - The vehicle is changing lanes.

- The system cannot detect white (yellow) lane lines.
- The DAA may not operate normally under the following conditions.
 - White (yellow) lane lines are less visible because of dirt or fading/patchiness.
 - The vehicle is jolted or swayed continuously by strong winds or rough roads.
 - The vehicle is driven aggressively.
 - When making frequent lane changes.
 - The vehicle is making a curve.
- The DAA detects driver fatigue and decreased attentiveness based on the driving data when the vehicle is driven at about 65 to 140 km/h (41 to 86 mph) for about 20 minutes. The driving data will be reset under the following conditions.
 - The vehicle is stopped for 15 minutes or longer.
 - The vehicle is driven at less than about 65 km/h (41 mph) for about 30 minutes.
 - The ignition is switched off.
- After the DAA has displayed the first message encouraging rest, it does not display the next one until 60 minutes have passed.

▼ **Driver Attention Alert (DAA) Display**

When the system detects driver fatigue or decreased attentiveness, it activates the warning sound and displays an alert in the multi-information display.

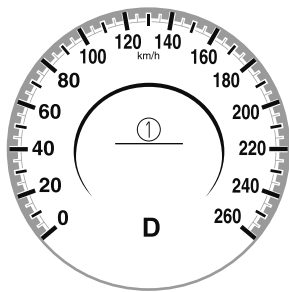

1. “Time for a Break” message is displayed

▼ **Cancelling Driver Attention Alert (DAA)**

The DAA can be set to not activate. Refer to the Settings section in the MZD Connect Owner's Manual.

Driver Monitoring (DM)*

▼ **Driver Monitoring (DM)**

The DM is a system which detects driver fatigue and sleepiness, and encourages the driver to take a rest.

While driving the vehicle at about 5 km/h (3 mph) or faster, the DM detects changes in the driver's facial features using the driver monitoring camera. The system then estimates the amount of accumulated fatigue and sleepiness of the driver and encourages the driver to take a rest using a warning indication in the instrument cluster and a warning sound.

Two types of warning indication patterns are set for notifying the driver based on the estimated amount of accumulated fatigue and sleepiness of the driver.

- Fatigue and sleepiness are detected: Warning pattern (caution)
- Much more fatigue and sleepiness are detected: Warning pattern (warning)

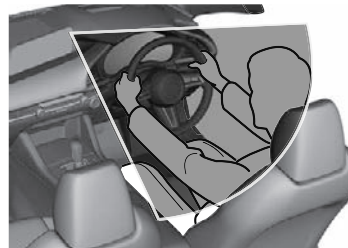

*Some models. **4-111**

! WARNING**Do not rely completely on the DM and always drive carefully:**

The DM is a system which detects driver fatigue and sleepiness, and encourages the driver to take a rest. This is not designed to prevent driver fatigue and sleepiness, and over-reliance on the system could lead to an accident. Drive carefully and turn the steering wheel appropriately. In addition, the system may not be able to detect driver fatigue and sleepiness correctly depending on the traffic and driving conditions. The driver must take sufficient rest in order to drive safely.

Operation conditions

The DM begins monitoring after 20 minutes have passed since the driver began driving the vehicle and when the vehicle speed is about 5 km/h (3 mph) or faster.

NOTE

- If the vehicle speed decreases to less than about 5 km/h (3 mph) while the DM is monitoring, the DM stops monitoring for 6 minutes even if the vehicle speed returns to about 5 km/h (3 mph) or faster.
- If the driver monitoring camera does not recognise the driver correctly, the DM may not monitor correctly.
Refer to Driver Monitoring Camera on page 4-217.
- After the DM has displayed the first message encouraging the driver to take a rest, it does not display it again during the following periods.

- After displaying the warning pattern (caution), the next warning pattern (caution) is not displayed until 45 minutes have passed.
- After displaying the warning pattern (warning), the next warning pattern (warning) is not displayed until 15 minutes have passed.
- After displaying the warning pattern (warning), the next warning pattern (caution) is not displayed until 45 minutes have passed.

▼ Driver Monitoring (DM) Display

When the Driver Monitoring (DM) detects driver fatigue or sleepiness, it activates the warning sound and displays an alert in the instrument cluster.

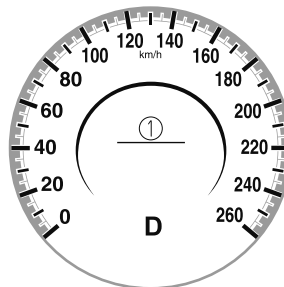
Warning pattern (caution) (white)

1. “Time for a Break” message is displayed

Warning pattern (warning) (amber)

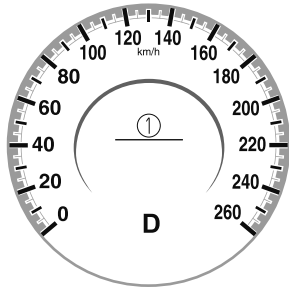

1. “Time for a Break” message is displayed

▼ Cancelling Driver Monitoring (DM)

The Driver Monitoring (DM) can be set to inoperable.

Refer to the Settings section in the MZD Connect Owner's Manual.

Front Cross Traffic Alert (FCTA)*

▼ Front Cross Traffic Alert (FCTA)

The FCTA is designed to assist the driver in checking both sides of the vehicle when the vehicle starts to drive at an intersection.

The FCTA detects vehicles approaching from the blind spots on the front left and right sides of the vehicle when the vehicle starts to drive at an intersection, and notifies the driver of possible danger using the warning indication on the display and the warning sound.

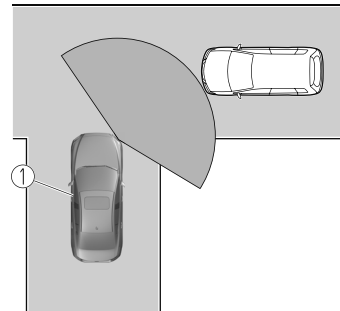

1. Your vehicle

⚠ WARNING

Always check the surrounding area visually when the vehicle starts to drive at an intersection:

Due to certain limitations with the operation of this system, the warning indication on the display or the warning sound might be delayed even though there is a vehicle approaching from a blind spot. Always make it your responsibility as a driver to check the left and right sides.

*Some models. **4-113**

i-ACTIVSENSE

Operation conditions

The system operates when all of the following conditions are met:

- When your vehicle is driven at less than about 10 km/h (6 mph).
- **(Automatic transmission)**
The selector lever is in the D position.
- **(Manual transmission)**
The shift lever is in a position other than N or R.
- When a vehicle approaches from the front side of your vehicle at a vehicle speed of about 5 km/h (3 mph) or faster.

FCTA operation

When your vehicle is stopped

When a vehicle is approaching, the system notifies the driver that a vehicle is approaching on the following display (white arrow).

Multi-information display

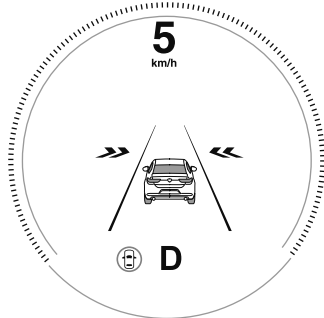

Active driving display (vehicles with active driving display)



360°view monitor (vehicles with 360°view monitor)



When your vehicle is being driven

If there is a possibility of a collision with an approaching vehicle, a warning indication is displayed on the following display (amber arrow) and the warning sound is activated at the same time.

Multi-information display

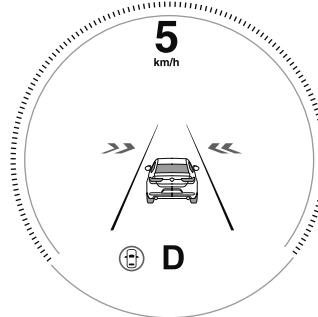

Active driving display (vehicles with active driving display)

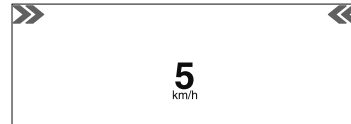

360°view monitor (vehicles with 360°view monitor)



NOTE

- The system may operate under the following conditions even if a vehicle is not approaching.
 - An object that reflects the radio waves of the radar such as a parked vehicle, guardrail, or wall is directly next to your vehicle.
 - Vehicles are stopped in the area around your vehicle such as during heavy traffic.
 - A vehicle approaching from the front or side of your vehicle slows down.
 - A vehicle approaching from the front or left side of your vehicle makes a right or left turn directly in front of your vehicle.
 - A vehicle or pedestrian moves in the parking lot or on the sidewalk in the area surrounding your vehicle.
 - After making a left or right turn, an on-coming vehicle is present.
 - When passing an on-coming vehicle.
 - A vehicle overtakes your vehicle while it is stopped.
 - Your vehicle is in an area where strong radio waves or electrical noise may occur such as near a television tower or power plant.
- Under the following conditions, the front side radar sensor cannot detect approaching vehicles or it might be difficult to detect them, and the system may not operate normally.
 - The front side radar sensor detection area is obstructed by a nearby wall or vehicle.
 - Directly after the system becomes operable.
 - Radio wave interference from a radar sensor equipped on a nearby vehicle.
 - The approaching vehicle has any of the following shapes.
 - a) The size of the vehicle body is extremely small.
 - b) The vehicle height is extremely low or high.
 - c) A special type of vehicle with a complex shape
 - A vehicle suddenly enters the detection area from the front or side of your vehicle.
 - A vehicle that has stopped suddenly starts to move.
 - Multiple objects move at the same time.
 - The vehicle is driven in bad weather conditions such as heavy rain, fog, snow, or sand storms.
 - The vehicle is driven on a sharp curve or on bumpy roads.
 - An object that reflects the radio waves of the radar such as a parked vehicle, guardrail, or wall is directly next to your vehicle.
 - A vehicle approaches while turning (Such as roundabout)
 - The vehicle is driven at an extremely slow speed.
- In the following cases, the system turns on the i-ACTIVSENSE warning indication/warning light and operation of the system is stopped. If the i-ACTIVSENSE warning indication/warning light remains on, have the vehicle inspected by an expert repairer, we recommend an Authorised Mazda Repairer as soon as possible.
 - Some problem with the system has occurred.

i-ACTIVSENSE

- The front side radar sensor installation position is greatly deviated.
- There is a large accumulation of snow or ice on the front bumper near a front side radar sensor.
- The temperature near the radar sensors becomes extremely hot due to driving for a long time on slopes during the summer.
- The battery voltage has decreased.
- The front side radar sensor of the FCTA may be regulated under the radio wave related laws of the country where the vehicle is driven. If this system is used abroad, it may be necessary to turn off the system. Refer to Front Side Radar Sensor on page 4-213.

▼ Cancelling Operation of Front Cross Traffic Alert (FCTA)

The FCTA can be set to inoperable.

- **(If only the FCTA is turned off)**
Refer to the Settings section in the MZD Connect Owner's Manual.
- **(If the FCTA is turned off by operating the i-ACTIVSENSE switch)**
Refer to i-ACTIVSENSE Switch on page 4-85.

NOTE

When the ignition is switched OFF, the system status before it was turned off is maintained. For example, if the ignition is switched OFF with the FCTA operable, the system will be operable when the ignition is switched ON the next time.

Rear Cross Traffic Alert (RCTA)

▼ Rear Cross Traffic Alert (RCTA)

The RCTA system is designed to assist the driver in checking the area to the rear left and right sides of your vehicle while your vehicle is reversing by alerting the driver to the presence of vehicles approaching the rear of your vehicle.

The RCTA system detects vehicles approaching from the rear left and right sides of your vehicle and the rear of your vehicle while your vehicle is being reversed out of a parking space, and notifies the driver of possible danger using the Blind Spot Monitoring (BSM) warning indicator lights and the warning buzzer.

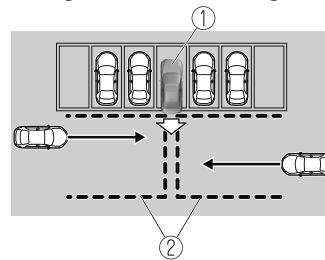

1. Your vehicle
2. Detection areas

⚠ WARNING

Always check the surrounding area visually before actually putting the vehicle in reverse:

The system is only designed to assist you in checking for vehicles at the rear when putting the vehicle in reverse. Due to certain limitations with the operation of this system, the Blind Spot Monitoring (BSM) warning indicator lights may not flash or it might be delayed even though a vehicle is behind your vehicle. Always make it your responsibility as a driver to check the rear.

RCTA operation

1. The RCTA system operates when the shift lever (manual transmission) or the selector lever (automatic transmission) is shifted to the reverse (R) position.
2. If there is the possibility of a collision with an approaching vehicle, the Blind Spot Monitoring (BSM) warning indicator lights flashes and the warning beep is activated simultaneously.

Rear view monitor (vehicles with Rear view monitor)

The RCTA warning indication in the rearview monitor also synchronizes with the Blind Spot Monitoring (BSM) warning indicator light on the door mirrors.

360°view monitor (vehicles with 360°view monitor)

The RCTA warning indication in the 360°view monitor also synchronizes with the Blind Spot Monitoring (BSM) warning indicator light on the door mirrors.

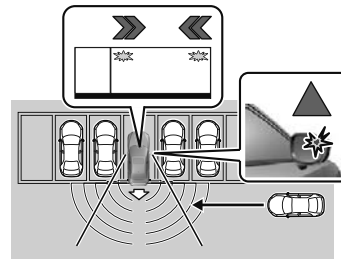

Function for cancelling illumination dimmer

If the BSM warning indicator lights turn on when the position lights are turned on, the brightness of the BSM warning indicator lights is dimmed.

If the BSM warning indicator lights are difficult to see due to glare from surrounding brightness when travelling on snow-covered roads or under foggy conditions, press the dimmer cancellation button to cancel the dimmer and increase the brightness of BSM warning indicator lights when they turn on.

Refer to Instrument Panel Illumination on page 4-25.

NOTE

- The system may operate under the following conditions even if a vehicle is not approaching.
 - An object that reflects the radio waves of the radar such as a parked vehicle, guardrail, or wall is directly next to your vehicle.

i-ACTIVSENSE

- A vehicle approaching from the rear left and right side of your vehicle slows down.
- A vehicle approaching from the rear left and right side of your vehicle makes a right or left turn directly in front of your vehicle.
- A vehicle overtakes your vehicle while it is stopped.
- Your vehicle is in an area where strong radio waves or electrical noise may occur such as near a television tower or power plant.
- In the following cases, the i-ACTIVSENSE warning indication/warning light turns on and operation of the system is stopped. If the i-ACTIVSENSE warning indication/warning light remains illuminated, have the vehicle inspected at an expert repairer; we recommend an Authorised Mazda Repairer as soon as possible.
 - Some problem with the system including the Blind Spot Monitoring (BSM) warning indicator lights has occurred.
 - A large deviation in the installation position of a rear side radar sensor on the vehicle has occurred.
 - There is a large accumulation of snow or ice on the rear bumper near a rear side radar sensor.
 - Driving on snow-covered roads for long periods.
 - The temperature near the radar sensors becomes extremely hot due to driving for long periods on slopes during the summer.
 - The battery voltage has decreased.

- Under the following conditions, the rear side radar sensor cannot detect approaching vehicles or it might be difficult to detect them, and the system may not operate normally.

- The vehicle speed when reversing is about 15 km/h (9 mph) or faster.
- The rear side radar sensor detection area is obstructed by a nearby wall or parked vehicle. (Reverse the vehicle to a position where the radar sensor detection area is no longer obstructed.)

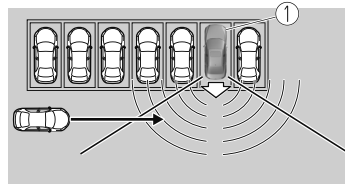

1. Your vehicle

- A vehicle is approaching directly from the rear of your vehicle.

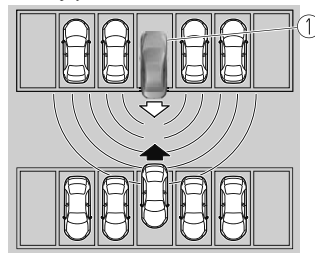

1. Your vehicle

- The vehicle is parked on a slant.

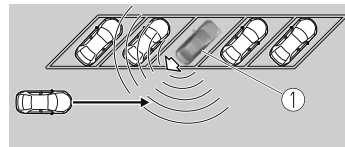

1. Your vehicle

- *Directly after the RCTA system becomes operable using the personalisation feature.*
- *Radio wave interference from a radar sensor equipped on a nearby parked vehicle.*
- *In the following cases, it may be difficult to view the illumination/flashing of the Blind Spot Monitoring (BSM) warning indicator lights equipped on the door mirrors.*
 - *Snow or ice adheres to the door mirrors.*
 - *The front door glass is fogged or covered in snow, frost or dirt.*
- *Turn off the RCTA system while pulling a trailer or while an accessory such as a bicycle carrier is installed to the rear of the vehicle. Otherwise, the radio waves emitted by the radar will be blocked causing the system to not operate normally.*
- *The rear side radar sensor of the RCTA may be regulated under the radio wave related laws of the country where the vehicle is driven. If this system is used abroad, it may be necessary to turn off the system.*

Refer to Rear Side Radar Sensor on page 4-214.
- *If a Mazda genuine trailer hitch is used, the RCTA is automatically turned off.*

▼ **Cancelling Operation of Rear Cross Traffic Alert (RCTA)**

The RCTA can be set to inoperable.

- **(If only the RCTA is turned off)**

Refer to the Settings section in the MZD Connect Owner's Manual.
- **(If the RCTA is turned off by operating the i-ACTIVSENSE switch)**

Refer to i-ACTIVSENSE Switch on page 4-85.

NOTE

When the ignition is switched OFF, the system status before it was turned off is maintained. For example, if the ignition is switched OFF with the RCTA operable, the system will be operable when the ignition is switched ON the next time.

Mazda Radar Cruise Control (MRCC) (Manual Transmission)

▼ Mazda Radar Cruise Control (MRCC)

The MRCC system is designed to maintain headway control*¹ with a vehicle ahead according to your vehicle's speed using a front radar sensor to detect the distance to the vehicle ahead and a preset vehicle speed without you having to use the accelerator or brake pedals.

*1 Headway Control: Control of the distance between your vehicle and the vehicle ahead detected by the MRCC system.

Additionally, if your vehicle starts closing in on the vehicle ahead such as if the vehicle ahead brakes suddenly, a warning sound and a warning indication in the display are activated simultaneously to alert you to maintain a sufficient distance between the vehicles.

Also refer to the following before using the MRCC.

- Front radar sensor (page 4-210)

WARNING

Do not rely completely on the MRCC:

The MRCC system has detection limitations depending on the type of vehicle ahead and its conditions, the weather conditions, and the road conditions. Additionally, the system may be unable to decelerate sufficiently to avoid hitting the vehicle ahead if the vehicle ahead applies the brakes suddenly or another vehicle cuts into the driving lane, which could result in an accident.

Always drive carefully and verify the surrounding conditions and depress the brake pedal or accelerator pedal while keeping a safe distance from vehicles ahead or on-coming vehicles.

Do not use the MRCC system in the following locations. Using the MRCC system at the following locations may result in an unexpected accident:

- *General roads other than highways (Driving under these conditions using the MRCC system is not possible.)*
- *Roads with sharp curves and where vehicle traffic is heavy and there is insufficient space between vehicles.*
- *Roads where frequent and repetitive acceleration and deceleration occur (Driving under these conditions using the MRCC system is not possible).*
- *When entering and exiting interchanges, service areas, and parking areas of highways (If you exit a highway while headway control is in use, the vehicle ahead will no longer be tracked and your vehicle may accelerate to the set speed).*

- *Slippery roads such as ice or snow-bound roads (Tyres could spin causing you to lose vehicle control, or the stop hold control may not operate.)*
- *Long, descending slopes (to maintain distance between vehicles, the system automatically and continuously applies the brakes which could result in the loss of brake power.)*
- *Two-wheeled vehicles such as motorcycles or bicycles are ahead.*
- *Slopes with a steep gradient (The vehicle ahead may not be detected correctly, your vehicle may slide while stopped by the stop hold control, and it may accelerate suddenly after it starts moving.)*

For safety purposes, switch the MRCC system off when it is not being used.



If your vehicle is towed or you are towing something, switch the MRCC system off to prevent an unexpected operation.

NOTE

- *The MRCC system does not detect the following as physical objects.*
 - *Vehicles approaching in the opposite direction*
 - *Pedestrians*
 - *Stationary objects (stopped vehicles, obstructions)*
 - *If a vehicle ahead is travelling at an extremely low speed, the system may not detect it correctly.*

- *If there is a structure on the road or an object (such as a monorail) at a low height off the ground in front of the vehicle, the system may operate. Therefore, do not use the MRCC.*
- *Do not use the MRCC system under conditions in which close proximity warnings are frequently activated.*
- *During headway control travel, the system accelerates and decelerates your vehicle in conjunction with the speed of the vehicle ahead. However, if it is necessary to accelerate for a lane change or if the vehicle ahead brakes suddenly causing you to close in on the vehicle rapidly, accelerate using the accelerator pedal or decelerate using the brake pedal depending on the conditions.*
- *While the MRCC system is in use, it does not cancel even if the shift lever is operated and any intended engine braking will not occur. If deceleration is required, lower the vehicle speed setting or depress the brake pedal.*
- *The sound of the automatic brakes operating may be heard, however, it does not indicate a problem.*
- *The brake lights turn on while the MRCC automatic braking is operating, however, they may not turn on while the vehicle is on a downslope at the set vehicle speed or travelling at a constant speed and following a vehicle ahead.*

▼ Mazda Radar Cruise Control (MRCC) Display Indication

The MRCC setting status and operation conditions are indicated on the multi-information display and the active driving display.

i-ACTIVSENSE

Multi-information display (Basic display)

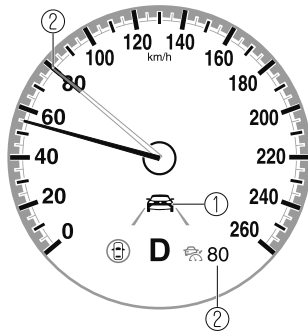

1. Vehicle ahead display
2. MRCC set vehicle speed

Multi-information display (i-ACTIVSENSE display)

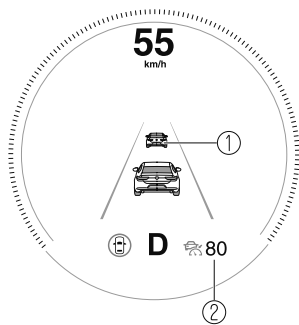

1. Vehicle ahead display
2. MRCC set vehicle speed

Active driving display

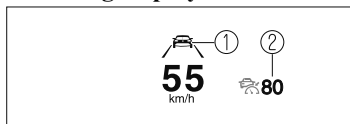

1. Vehicle ahead display
2. MRCC set vehicle speed

If there is a problem with the MRCC system, a message is displayed on the multi-information display. Check the centre display to verify the problem and then have your vehicle inspected by an expert repairer, we recommend an Authorised Mazda Repairer. Refer to If a Warning Light Turns On or Flashes on page 7-23.

▼ Close Proximity Warning

If your vehicle rapidly closes in on the vehicle ahead because the vehicle ahead applies the brakes suddenly while you are travelling in headway control, the warning sound activates and the brake warning is indicated in the display. Always verify the safety of the surrounding area and depress the brake pedal while keeping a safe distance from the vehicle ahead. Additionally, keep a safe distance from the vehicles behind you.

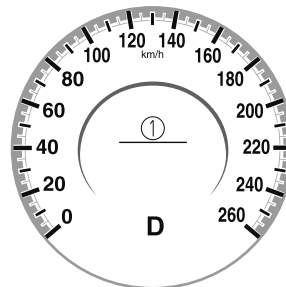

1. "Depress Brake Pedal" message is displayed

NOTE

In the following cases, the warnings and brakes may not operate even if your vehicle starts closing in on the vehicle ahead.

When Driving
i-ACTIVSENSE

- *You are driving your vehicle at the same speed as the vehicle ahead.*
- *Directly after the MRCC system has been set.*
- *Directly after the accelerator pedal is released.*
- *Another vehicle cuts into the driving lane.*

When Driving

i-ACTIVSENSE

▼ Setting the System

The MRCC system operates when all of the following conditions are met.

- Vehicle speed is 30 km/h (19 mph) to 145 km/h (90 mph)
- The MRCC is turned on.
- The brake pedal is not depressed.
- The parking brake is released (Electric Parking Brake (EPB) indicator light is turned off).
- There is no problem with the DSC.
- All the doors are closed.
- The driver's seat belt is fastened.
- The shift lever is in a position other than reverse (R) or neutral (N).
- The clutch pedal is not depressed.

NOTE

When the MRCC is operating, Distance & Speed Alert (DSA), and Smart Brake Support (SBS) also turns on automatically.

Turning on the system

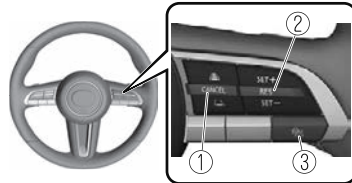

1. CANCEL switch
2. RES switch
3. MRCC switch

When the MRCC switch is pressed once, the MRCC system turns on, and the MRCC standby indication (white) turns on and the vehicle speed and the distance between the vehicles while in headway control can be set.



In addition, the MRCC system display indication is displayed on the multi-information display and the active driving display at the same time.

NOTE

- *If the ignition is switched off while the MRCC system is operating, the system will be operable when the ignition is switched ON the next time.*

4-124

- Stop the headway control function to switch the system to the cruise control function.
 Refer to the Settings section in the MZD Connect Owner's Manual.

How to set the speed

Adjust the vehicle speed to the desired setting using the accelerator pedal and press the RES switch up (SET+) or down (SET-) to start headway control.

The set speed is indicated on the display. At the same time, the MRCC standby indication (white) changes to the MRCC set indication (green).



Travel status	Indication on multi-information display	Indication on active driving display
During travel at constant speed		80 km/h
During travel under headway control		55 km/h

NOTE

- If a vehicle ahead is detected while travelling at a constant speed, the vehicle-ahead indication is displayed and headway control is performed. Additionally, when a vehicle ahead is no longer detected, the vehicle-ahead indication turns off and the system switches back to travel at constant speed.
- The lowest possible speed which can be set on the MRCC system is 30 km/h (19 mph).
- Headway control is not possible if the vehicle ahead is driving faster than your vehicle's set speed. Adjust the system to the desired vehicle speed using the accelerator pedal.



How to set the distance-between-vehicles during headway control

The distance-between-vehicles can be set to 4 levels; Long, medium, short, and extremely short distance.

When Driving

i-ACTIVSENSE

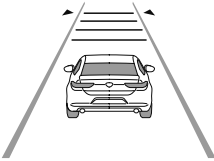
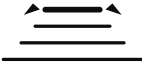
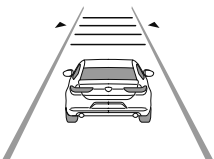
The distance-between-vehicles is set to a shorter distance by pressing the CANCEL switch down. The distance-between-vehicles is set to a longer distance by pressing the CANCEL switch up.

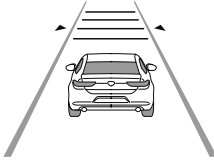
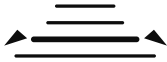
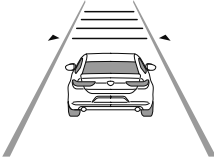
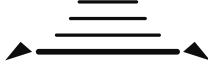
Distance-between-vehicles guideline (at 80 km/h (50 mph) vehicle speed)	Indication on multi-information display	Indication on active driving display*1
Long (about 50 m (164 ft))		
Medium (about 40 m (131 ft))		
Short (about 30 m (98 ft))		
Extremely short (about 25 m (82 ft))		

*1 Displays a pop-up image in the active driving display only when the driver operates the switch.

NOTE

- The distance-between-vehicles differs depending on the vehicle speed, and the slower the vehicle speed, the shorter the distance.
- When the ignition is switched to ACC or OFF and then the engine is started again, the system automatically sets the distance-between-vehicles to the previous setting.

Changing the Set Vehicle Speed

To accelerate/decelerate using the RES switch

When the RES switch is pressed up (SET+), the vehicle accelerates and when the RES switch is pressed down (SET-), it decelerates.

- Press and release immediately: 1 km/h (1 mph)
- Press and hold: 10 km/h (5 mph)

To increase speed using accelerator pedal

Depress the accelerator pedal and press the RES switch up (SET+) or down (SET-) at the desired speed. If the switch is not operated, the system returns to the set speed after you release your foot from the accelerator pedal.

NOTE

- The warnings and brake control do not operate while the accelerator pedal is depressed.

Cancelling the system

When the following operations are performed, the MRCC system is cancelled, and the MRCC set indication (green) switches to the MRCC standby indication (white) at the same time.

- The CANCEL switch is pressed.
- The brake pedal is depressed.

- The shift lever is in the reverse (R) position.

Under the following conditions, the MRCC cancel indication is displayed in the multi-information display and a single beep sound is heard.

- The DSC has operated.
- The Smart Brake Support (SBS) has operated.
- When travelling on a downslope for a long period of time.
- There is a problem with the system.
- The front radar sensor cannot detect target objects (during rain, fog, snow or other inclement weather conditions, or when the radiator grille is dirty).
- The vehicle speed decreases to less than 25 km (16 mph).
- The shift lever is shifted to neutral (N) for a certain period of time.
- The clutch is depressed for a certain period of time.
- The engine stalls.
- The parking brake is applied.
- Any of the doors is opened.
- The driver's seat belt is unfastened.

Resuming control

If the MRCC system is cancelled, you can resume control at the previously set speed by pressing the RES switch and after all of the operation conditions have been met.

NOTE

If the set speed is not indicated in the display, the control does not resume even if the RES switch is pressed.

Turning off the system

When the MRCC switch is pressed while the MRCC is operating, the MRCC turns off.

▼ Shift-up/Shift-down Request Display

The shift-up or shift-down request display might be displayed while the MRCC is operating. When this occurs, shift gears because the gear position is not appropriate.

Request	Indication on display
Shift up	Shift Up to a Higher Gear
Shift down	Shift Down to a Lower Gear

NOTE

- *If the gears are not shifted up even though the shift-up request indication is displayed, load will be applied to the engine and the MRCC might be automatically cancelled or engine damage could occur.*
- *If the gears are not shifted down even though the shift-down request indication is displayed, the MRCC might be automatically cancelled or engine stalling could occur.*

Mazda Radar Cruise Control with Stop & Go function (MRCC with Stop & Go function) (Automatic Transmission)

▼ Mazda Radar Cruise Control with Stop & Go function (MRCC with Stop & Go function)

The MRCC with Stop & Go function system is designed to maintain headway control*1 with a vehicle ahead according to your vehicle's speed using a front radar sensor to detect the distance to the vehicle ahead and a preset vehicle speed without you having to use the accelerator or brake pedals.

*1 Headway Control: Control of the distance between your vehicle and the vehicle ahead detected by the Mazda Radar Cruise Control (MRCC) system.

Additionally, if your vehicle starts closing in on the vehicle ahead such as if the vehicle ahead brakes suddenly, a warning sound and a warning indication in the display are activated simultaneously to alert you to maintain a sufficient distance between the vehicles.

If the vehicle ahead stops while you are following behind it, your vehicle will stop and be held stopped automatically (stop hold control), and headway control will resume when you resume driving the vehicle such as by pressing the RES switch.

Also refer to the following before using the MRCC with Stop & Go function.

- i-stop (page 4-11)
- AUTOHOLD (page 4-69)
- Forward Sensing Camera (FSC) (page 4-206)
- Front radar sensor (page 4-210)

WARNING

Do not rely completely on the MRCC with Stop & Go function:

The MRCC with Stop & Go function system has detection limitations depending on the type of vehicle ahead and its conditions, the weather conditions, and the road conditions. Additionally, the system may be unable to decelerate sufficiently to avoid hitting the vehicle ahead if the vehicle ahead applies the brakes suddenly or another vehicle cuts into the driving lane, which could result in an accident. Always drive carefully and verify the surrounding conditions and depress the brake pedal or accelerator pedal while keeping a safe distance from vehicles ahead or on-coming vehicles.

Do not use the MRCC with Stop & Go function system in the following locations. Using the MRCC with Stop & Go function system at the following locations may result in an unexpected accident:

- General roads other than highways (Driving under these conditions using the MRCC with Stop & Go function system is not possible.)
- Roads with sharp curves and where vehicle traffic is heavy and there is insufficient space between vehicles.

- Roads where frequent and repetitive acceleration and deceleration occur (Driving under these conditions using the MRCC with Stop & Go function system is not possible).
- When entering and exiting interchanges, service areas, and parking areas of highways (If you exit a highway while headway control is in use, the vehicle ahead will no longer be tracked and your vehicle may accelerate to the set speed).
- Slippery roads such as ice or snow-bound roads (Tyres could spin causing you to lose vehicle control, or the stop hold control may not operate.)
- Long, descending slopes (to maintain distance between vehicles, the system automatically and continuously applies the brakes which could result in the loss of brake power.)
- Two-wheeled vehicles such as motorcycles or bicycles are ahead.
- Slopes with a steep gradient (The vehicle ahead may not be detected correctly, your vehicle may slide while stopped by the stop hold control, and it may accelerate suddenly after it starts moving.)

For safety purposes, switch the MRCC with Stop & Go function system off when it is not being used.

Do not get out of the vehicle while the stop hold control is operating:

Getting out of the vehicle while the stop hold control is operating is dangerous as the vehicle may move unexpectedly and result in an accident. Before getting out of the vehicle, switch the MRCC with Stop & Go function system off, shift the selector lever to the P position, and apply the parking brake.

CAUTION

If your vehicle is towed or you are towing something, switch the MRCC with Stop & Go function system off to prevent an unexpected operation.

NOTE

- The MRCC with Stop & Go function system does not detect the following as physical objects.
 - Vehicles approaching in the opposite direction
 - Pedestrians
 - Stationary objects (stopped vehicles, obstructions)
 - If a vehicle ahead is travelling at an extremely low speed, the system may not detect it correctly.
- If there is a structure on the road or an object (such as a monorail) at a low height off the ground in front of the vehicle, the system may operate. Therefore, do not use the MRCC with Stop & Go function.

- Do not use the MRCC with Stop & Go function system under conditions in which close proximity warnings are frequently activated.
- During headway control travel, the system accelerates and decelerates your vehicle in conjunction with the speed of the vehicle ahead. However, if it is necessary to accelerate for a lane change or if the vehicle ahead brakes suddenly causing you to close in on the vehicle rapidly, accelerate using the accelerator pedal or decelerate using the brake pedal depending on the conditions.
- While the MRCC with Stop & Go function system is in use, it does not cancel even if the selector lever is operated and any intended engine braking does not occur. If deceleration is required, lower the set speed or depress the brake pedal.
- The sound of the automatic brakes operating may be heard, however, it does not indicate a problem.
- The brake lights turn on while the MRCC with Stop & Go function automatic braking is operating, however, they may not turn on while the vehicle is on a downslope at the set vehicle speed or travelling at a constant speed and following a vehicle ahead.

▼ Mazda Radar Cruise Control with Stop & Go function (MRCC with Stop & Go function) Display Indication

The MRCC with Stop & Go function setting status and operation conditions are indicated on the multi-information display and the active driving display.

Multi-information Display (Basic display)

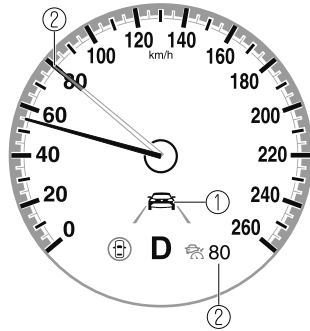

1. Vehicle ahead display
2. MRCC with Stop & Go function set vehicle speed

Multi-information Display (i-ACTIVSENSE display)

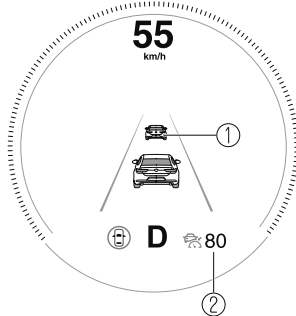

1. Vehicle ahead display
2. MRCC with Stop & Go function set vehicle speed

Active driving display

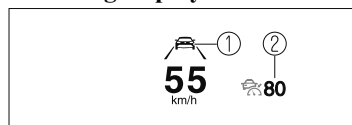

1. Vehicle ahead display

2. MRCC with Stop & Go function set vehicle speed

If there is a problem with the MRCC with Stop & Go function system, a message is displayed on the multi-information display. Check the centre display to verify the problem and then have your vehicle inspected by an expert repairer, we recommend an Authorised Mazda Repairer.

Refer to If a Warning Light Turns On or Flashes on page 7-23.

▼ Close Proximity Warning

If your vehicle rapidly closes in on the vehicle ahead because the vehicle ahead applies the brakes suddenly while you are travelling in headway control, the warning sound activates and the brake warning is indicated in the display. Always verify the safety of the surrounding area and depress the brake pedal while keeping a safe distance from the vehicle ahead.

Additionally, keep a safe distance from the vehicles behind you.

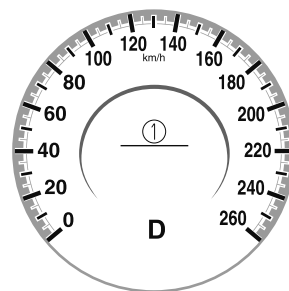

1. "Depress Brake Pedal" message is displayed

When Driving

i-ACTIVSENSE

NOTE

In the following cases, the warnings and brakes may not operate even if your vehicle starts closing in on the vehicle ahead.

- *You are driving your vehicle at the same speed as the vehicle ahead.*
- *Directly after the MRCC with Stop & Go function system has been set.*
- *Directly after the accelerator pedal is released.*
- *Another vehicle cuts into the driving lane.*

▼ Setting the System

The MRCC with Stop & Go function system operates when all of the following conditions are met.

- Vehicle speed is 0 km/h (0 mph) to 145 km/h (90 mph)
- The MRCC with Stop & Go function is turned on.
- The brake pedal is not depressed.
- The parking brake is released (Electric Parking Brake (EPB) indicator light is turned off).
- There is no problem with the DSC.
- All the doors are closed.
- The driver's seat belt is fastened.
- The selector lever is in the drive (D) position or manual (M) position (manual mode).

NOTE

- *In the following cases, the MRCC with Stop & Go function system is cancelled when the vehicle is travelling at 30 km/h (20 mph) or less and “Mazda Radar Cruise Control Disabled Under 30 km/h (20 mph)” is displayed in the multi-information display.*
 - *The Forward Sensing Camera (FSC) cannot detect target objects (There is problem with the Forward Sensing Camera (FSC) or windscreen is dirty).*
 - *There is a problem with the stop hold control function.*
 - *There is a problem with the Electric Parking Brake (EPB).*
- *When the MRCC with Stop & Go function system is operating, Distance & Speed Alert (DSA), and Smart Brake Support (SBS) also turns on automatically.*
- *It may not be possible to set the MRCC with Stop & Go function system directly after starting the engine, while the DSC operation is being checked.*

Turning on the system

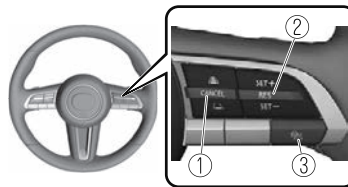

1. CANCEL switch
2. RES switch
3. MRCC switch

When Driving

i-ACTIVSENSE

When the MRCC switch is pressed once, the MRCC with Stop & Go function system turns on, and the MRCC with Stop & Go function standby indication (white) turns on and the vehicle speed and the distance between the vehicles while in headway control can be set.



In addition, the MRCC with Stop & Go function system display indication is displayed on the multi-information display and the active driving display at the same time.

NOTE





- If the ignition is switched off while the MRCC with Stop & Go function system is operating, the system will be operable when the ignition is switched ON the next time.
- Stop the headway control function to switch the system to the cruise control function. Refer to the Settings section in the MZD Connect Owner's Manual.

How to set the speed

Adjust the vehicle speed to the desired setting using the accelerator pedal and press the RES switch up (SET+) or down (SET-) to start headway control.

The set speed is indicated on the display. At the same time, the MRCC standby indication (white) changes to the MRCC set indication (green).

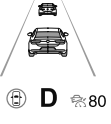

Travel status	Indication on multi-information display	Indication on active driving display
During travel at constant speed		
During travel under headway control		



NOTE

- If a vehicle ahead is detected while travelling at a constant speed, the vehicle-ahead indication is displayed and headway control is performed. Additionally, when a vehicle ahead is no longer detected, the vehicle-ahead indication turns off and the system switches back to travel at constant speed.
- The lowest possible speed which can be set on the MRCC with Stop & Go function system is 30 km/h (19 mph).
- Headway control is not possible if the vehicle ahead is driving faster than your vehicle's set speed. Adjust the system to the desired vehicle speed using the accelerator pedal.

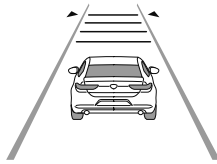
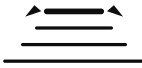
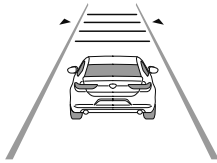

How to set the distance-between-vehicles during headway control

The distance-between-vehicles can be set to 4 levels; Long, medium, short, and extremely short distance.

The distance-between-vehicles is set to a shorter distance by pressing the CANCEL switch down. The distance-between-vehicles is set to a longer distance by pressing the CANCEL switch up.

Distance-between-vehicles guideline (at 80 km/h (50 mph) vehicle speed)	Indication on multi-information display	Indication on active driving display*1
Long (about 50 m (164 ft))		
Medium (about 40 m (131 ft))		

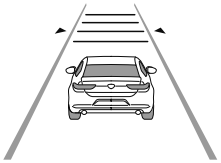
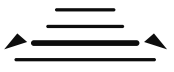
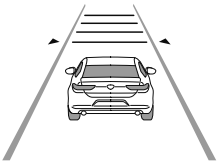
i-ACTIVSENSE

Distance-between-vehicles guideline (at 80 km/h (50 mph) vehicle speed)	Indication on multi-information display	Indication on active driving display*1
Short (about 30 m (98 ft))		
Extremely short (about 25 m (82 ft))		

*1 Displays a pop-up image in the active driving display only when the driver operates the switch.

NOTE

- The distance-between-vehicles differs depending on the vehicle speed, and the slower the vehicle speed, the shorter the distance.
- When the ignition is switched to ACC or OFF and then the engine is started again, the system automatically sets the distance-between-vehicles to the previous setting.

Changing the Set Vehicle Speed

To accelerate/decelerate using the RES switch

When the RES switch is pressed up (SET+), the vehicle accelerates and when the RES switch is pressed down (SET-), it decelerates.

- Press and release immediately: 1 km/h (1 mph)
- Press and hold: 10 km/h (5 mph)

To increase speed using accelerator pedal

Depress the accelerator pedal and press the RES switch up (SET+) or down (SET-) at the desired speed. If the switch is not operated, the system returns to the set speed after you release your foot from the accelerator pedal.

NOTE

- The warnings and brake control do not operate while the accelerator pedal is depressed.

Cancelling the system

When the following operations are performed, the MRCC with Stop & Go function system is cancelled, and the MRCC with Stop & Go function set indication (green) switches to the MRCC with Stop & Go function standby indication (white) at the same time.

- The CANCEL switch is pressed.
- The brake pedal is depressed.
- The selector lever is in the P (Park), N (Neutral), or R (Reverse) position.

Under the following conditions, the MRCC with Stop & Go function cancel indication is displayed in the multi-information display and a single beep sound is heard.

- The DSC has operated.
- The Smart Brake Support (SBS) has operated.
- When travelling on a downslope for a long period of time.
- There is a problem with the system.
- The parking brake is automatically applied during stop hold control.
- The front radar sensor cannot detect target objects (during rain, fog, snow or other inclement weather conditions, or when the radiator grille is dirty).
- The parking brake is applied.
- Any of the doors is opened.
- The driver's seat belt is unfastened.

Resuming control

If the MRCC with Stop & Go function system is cancelled, you can resume control at the previously set speed by pressing the RES switch and after all of the operation conditions have been met.

NOTE

If the set speed is not indicated in the display, the control does not resume even if the RES switch is pressed.

Turning off the system

When the MRCC switch is pressed while the MRCC is operating, the MRCC turns off.

▼ Stop Hold Control

While in headway control using the MRCC with Stop & Go function system, your vehicle will stop when a vehicle ahead stops. When the vehicle is stopped and the stop hold control operates, the MRCC with Stop & Go function indicator light turns on.

HOLD

NOTE

- *If the MRCC with Stop & Go function system is cancelled during stop hold control, the vehicle is held in its stopped position.*
- *The parking brake is automatically applied and the vehicle is held in its stopped position when 10 minutes have elapsed since the stop hold control operated. At this time, the MRCC with Stop & Go function system is cancelled.*
- *If the i-stop operation conditions are met during stop hold control, the engine stops even though the brake pedal is not depressed.*
Refer to i-stop on page 4-11.
- *The brake lights turn on during stop hold control.*

To resume driving

After the vehicle ahead starts moving while your vehicle is stopped under stop hold control, press the RES switch or depress the accelerator pedal to cancel the stop hold control and resume driving.

NOTE

- *When you resume driving by pressing the RES switch, your vehicle does not start moving until the distance between your vehicle and the vehicle ahead lengthens to the specified distance or farther.*
- *The engine restarts automatically when any of the actions to resume driving are performed while i-stop is operating.*
- *If the MRCC with Stop & Go function is temporarily cancelled during stop hold control, you cannot resume driving by pressing the RES switch when there are no vehicles in front of your vehicle. Depress the accelerator pedal and resume driving the vehicle.*
- *If the vehicle ahead starts moving within 3 seconds after your vehicle is stopped by the stop hold control, headway control will resume even if you do not resume driving your vehicle, such as by depressing the accelerator pedal.*

Resume driving information

If you do not resume driving within a few seconds after the vehicle ahead starts moving, the multi-information display vehicle-ahead indication flashes to urge the driver to resume driving. If you do not resume driving after the indicator light flashes, a sound is activated to urge you to resume driving.

4-138 *Some models.

Cruising & Traffic Support (CTS)*

▼ Cruising & Traffic Support (CTS)

The CTS is a system which consists of a headway control function and steering assist function for reducing driver fatigue when driving in a traffic jam on expressways or highways.

The system performs headway control to maintain a constant distance between your vehicle and a vehicle ahead at a preset vehicle speed without you having to use the accelerator or brake pedal. Even further, with the steering assist function, when vehicle lane lines are detected, the function assists the driver in keeping the vehicle within the lane lines. If lane lines are not detected, the function provides the driver driving assistance in keeping the vehicle along the motion path with the vehicle ahead.

WARNING

Do not rely completely on CTS:

- *The CTS is not an automated driving system. In addition, the functions have limitations. Do not rely completely on the system and always stay on course using the steering wheel.*
- *Set a vehicle speed within the speed limit according to the road conditions and the weather conditions.*

- *The CTS may not be able to detect a vehicle ahead depending on the type of vehicle ahead and its conditions, the weather conditions, and the road conditions. Additionally, the system might be unable to decelerate sufficiently if a vehicle ahead applies the brakes suddenly, another vehicle cuts into the driving lane, or the difference in vehicle speed between your vehicle and the vehicle ahead is larger, which could result in an accident. Check the surrounding conditions and always drive carefully while keeping a safe distance from vehicles ahead and on-coming vehicles.*
 - *While the CTS is in use, any intended engine braking does not occur even if you shift the shift lever (manual transmission) or the selector lever (automatic transmission). If deceleration is required, lower the vehicle speed setting or depress the brake pedal.*
- For the purposes of safety, switch the CTS off when it is not being used.**
- Do not use the CTS under the following conditions. Otherwise, it may result in an accident.**
- *General roads other than expressways or highways (Driving under these conditions using the CTS is not possible.)*
 - *Roads with sharp curves and where vehicle traffic is heavy with insufficient space between vehicles. Roads where frequent and repetitive acceleration and deceleration occur (Driving under these conditions using the CTS is not possible).*
 - *When entering and exiting interchanges, service areas, and parking areas of expressways (If you exit an expressway while headway control is in use, the vehicle ahead will no longer be tracked and your vehicle may accelerate to the set speed).*
 - *Long, descending slopes (to maintain distance between vehicles, the system automatically and continuously applies the brakes which could result in the loss of brake power.)*
 - *The vehicle ahead is travelling at an extremely slow speed.*
 - *Two-wheeled vehicles such as motorcycles or bicycles are ahead.*
 - **(Automatic transmission vehicle)**
Slopes with a steep gradient (The vehicle ahead may not be detected correctly, your vehicle may slip while stopped by the stop hold control, or it may accelerate suddenly after it starts moving.)
 - *Driving under bad weather conditions (rain, fog, and snow).*
 - *The CTS cannot detect lane lines.*
 - *Narrow roads resulting from road construction or lane closures.*
 - *The vehicle is driven on slippery roads such as icy or snow-covered roads and unpaved roads (Tyres could spin causing you to lose vehicle control, or the stop hold control may not operate.)*
 - *Tyres of a different specified size are used, such as a temporary spare tyre.*
 - *Tyres with insufficient tread are used.*
 - *The tyre pressures are not adjusted to the specified pressure.*
 - *The vehicle is being used to tow a camper or boat trailer.*
 - *Tyre chains are used.*

- The vehicle is driven on roads with lane lines other than white (yellow) lines, such as an expressway.

(Automatic transmission vehicle)

Do not get out of the vehicle while the stop hold control is operating.

Getting out of the vehicle while the stop hold control is operating is dangerous as the vehicle may move unexpectedly and result in an accident. Before getting out of the vehicle, switch the CTS off, apply the parking brake, and then shift the selector lever to the P position.



Turn the system off when the vehicle is running on a chassis roller.
Heed the following cautions so that the CTS can operate normally.

- Do not modify the vehicle's suspensions.
- Always use wheels of the specified type and size for the front and rear wheels. Consult an expert repairer, we recommend an Authorised Mazda Repairer for tyre replacement.

NOTE

- The headway control does not detect the following as physical objects.
 - Vehicles approaching in the opposite direction
 - Pedestrians
 - Stationary objects (stopped vehicles, obstructions)

4-140

- If a vehicle ahead is travelling at an extremely low speed, the system may not detect it correctly.
- If there is a structure on the road or an object (such as a monorail) at a low height off the ground in front of the vehicle, the system may operate. Therefore, do not use the CTS.
- Do not use the CTS under conditions in which close proximity warnings are frequently activated.
- If it is necessary to accelerate for a lane change or the vehicle ahead brakes suddenly causing you to close in on the vehicle rapidly, accelerate using the accelerator pedal or decelerate using the brake pedal depending on the conditions.
- While the CTS is in use, it does not cancel even if the selector lever is operated and any intended engine braking does not occur. If deceleration is required, lower the set speed or depress the brake pedal.
- You might hear the sound of the automatic brakes operating; however, it does not indicate a problem.
- The brake lights turn on while the CTS automatic braking is operating, however, they may not turn on while the vehicle is on a downslope at the set vehicle speed or travelling at a constant speed and following a vehicle ahead.
- Under the following conditions, the CTS may not be able to detect white (yellow) lines correctly and the CTS may not operate normally.
 - The forward sensing camera (FSC) cannot recognise the area in front of the vehicle due to soiling or fog.

- *The white (yellow) lane lines are less visible because of dirt or paint flaking.*
- *White (yellow) lane lines are less visible because of bad weather (rain, fog, or snow).*
- *The vehicle is driven on a temporary lane or section with a closed lane resulting from construction where there might be multiple white (yellow) lane lines, or they are interrupted.*
- *The camera picks up an obscure line, such as a temporary line being used for construction, or because of shade, unmelted snow, or grooves filled with water.*
- *The road surface is wet and shiny after rain, or there are puddles on the road.*
- *Heavy luggage is loaded in the luggage compartment or on the rear seat causing the vehicle to tilt.*
- *A vehicle in front of your vehicle is running near a white (yellow) lane line making it less visible.*
- *The windscreen is dirty or foggy.*
- *The tyre pressures are not adjusted to the specified pressure.*
- *Tyres other than standard tyres are equipped.*
- *The vehicle is driven through an intersection, a junction, or a fork in the road.*
- *While white (yellow) lane lines cannot be detected due to road or weather conditions.*
- *The surrounding brightness suddenly changes such as when entering or exiting a tunnel.*
- *The illumination of the headlights is weakened because of dirt or the optical axis is deviated at night.*
- *Back-light is reflected off the road surface or the road surface is wet and shiny after rain.*
- *The shade of a guardrail parallel to a white (yellow) lane line is cast on the road.*
- *The width of a lane is excessively narrow or wide.*
- *The road is excessively uneven.*
- *The vehicle is shaken after hitting a road bump.*
- *There are various road markings or division lines (lane markings) of various shapes near an intersection.*
- *An object that obstructs the field of view is installed to the vehicle.*
- *Exhaust gas from the vehicle in front, sand, snow, and water vapour rising from manholes and grating, and water splashed into the air.*
- *The surroundings are dark such as during the early evening or early morning.*
- *A vehicle ahead may be out of the recognition area on roads with tight curves, where the vehicle might not be able to follow the vehicle ahead.*

i-ACTIVSENSE

Headway control function

If a vehicle ahead is detected while travelling at a constant speed, the vehicle-ahead indication is displayed and headway control is performed.

Steering assist function

When lane lines are detected, the function assists the driver in keeping the vehicle within the lane lines. If lane lines are not detected, the function provides the driver driving assistance in keeping the vehicle along the motion path with the vehicle ahead.

NOTE

Steering assist limit warning

If the steering assist function cannot keep the vehicle within the lane lines while the steering assist function is operating, a warning sound is activated and a warning is displayed on the multi-information display to urge the driver to operate the steering wheel.

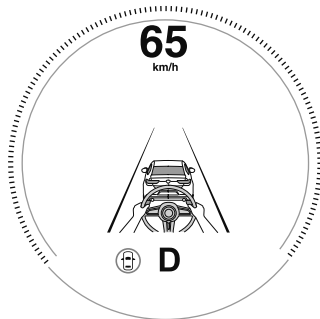

▼ Cruising & Traffic Support (CTS) Display Indication

The CTS setting status and operation conditions are indicated on the multi-information display or the active driving display.

Multi-information display (Basic display)

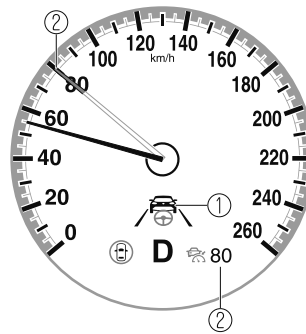

1. Vehicle ahead display
2. CTS set vehicle speed

Multi-information display (i-ACTIVSENSE display)

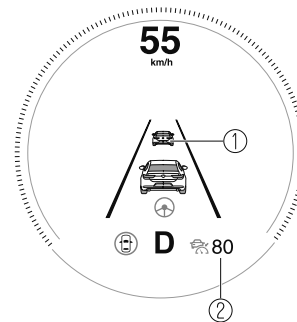

1. Vehicle ahead display
2. CTS set vehicle speed

Active driving display

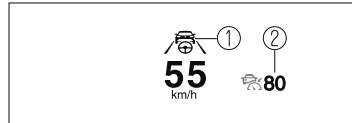

1. Vehicle ahead display
2. CTS set vehicle speed

Steering assist function display

When the steering assist function operates, the steering assist operation display on the display changes from white to green.

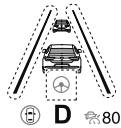

NOTE

You can view the multi-information display to check whether the steering assist is performing controls in conjunction with the traffic lane lines or a vehicle ahead.

Inactive

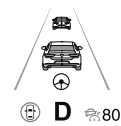

Active (vehicle ahead)

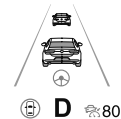

Active (lane line)



If there is a problem with the CTS, a message is displayed on the multi-information display. Check the details of the problem on the centre display and then have your vehicle inspected by an expert repairer, we recommend an Authorised Mazda Repairer.

Refer to If a Warning Light Turns On or Flashes on page 7-23.

▼ Close Proximity Warning

If your vehicle rapidly closes in on the vehicle ahead while you are travelling under headway control, the warning sound is activated and the brake warning is indicated on the display. Keep a safe distance between your vehicle and a vehicle ahead.

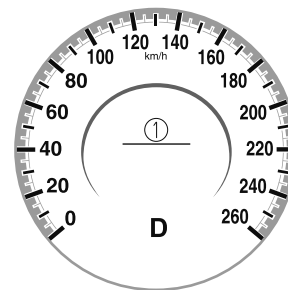

1. “Depress Brake Pedal” message is displayed

When Driving

i-ACTIVSENSE

NOTE

In the following cases, the warnings and brakes may not operate even if your vehicle starts closing in on the vehicle ahead.

- Directly after the CTS operates.*
- Directly after the accelerator pedal is released.*
- Another vehicle cuts into the driving lane.*

4-144

▼ Setting the System

Operation conditions

Headway control function

The headway control function operates when all of the following conditions are met.

- **(Automatic transmission vehicle)**
The vehicle speed is about 0 km/h (0 mph) to 145 km/h (90 mph).
- **(Manual transmission vehicle)**
The vehicle speed is about 30 km/h (19 mph) to 145 km/h (90 mph).
- The CTS is operating.
- The headway control function of the Mazda Radar Cruise Control (MRCC) or Mazda Radar Cruise Control with Stop & Go function (MRCC with Stop & Go function) is set to operable (if it was set to inoperable, set it to operable using the personalisation function).
- The brake pedal is not depressed.
- The parking brake is released (Electric Parking Brake (EPB) indicator light is turned off).
- All the doors are closed.
- The driver's seat belt is fastened.
- **(Automatic transmission vehicle)**
The selector lever is in the D or M position (manual mode).
- **(Manual transmission vehicle)**
 - The shift lever is in a position other than the R or N position.
 - The clutch pedal is not depressed.

NOTE

(Automatic transmission vehicle)

- *Under the following conditions, the CTS cannot be used when the vehicle speed is 30 km/h (20 mph) or slower. In addition, a message, "Mazda Radar Cruise Control Disabled Under 30 km/h (20 mph)" is displayed in the multi-information display.*
 - *The forward sensing camera (FSC) cannot detect target objects (windscreen is damaged or dirty).*
 - *There is a problem with the stop hold control function.*
 - *There is a problem with the Electric Parking Brake (EPB).*
- *The CTS may not launch directly after the engine starts.*

Steering assist function

The steering assist function operates under the following conditions.

When Driving

i-ACTIVSENSE

- Your vehicle is moving and less than about 55 km/h (34 mph).
- White (yellow) lane lines on both sides are detected and you are driving near the centre of the lane, or your vehicle detects a vehicle ahead.
- The steering wheel is not turned sharply.
- The direction indicator lever is not operated.
- The headway control function is operating.
- **(Manual transmission vehicle)**
The vehicle speed is about 30 km/h (19 mph) or faster.

NOTE

The steering assist function operates so that the vehicle remains near the centre of the driving lane, however, depending on conditions such as the road curvature, road slope and undulations, and vehicle speed, the function might not be able to keep the vehicle near the centre of the driving lane.

Setting method

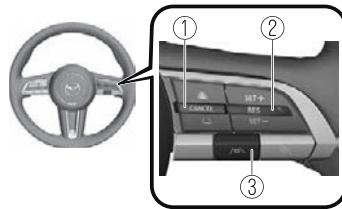

1. CANCEL switch
2. RES switch
3. CTS switch

1. Press the CTS switch.
The CTS standby indication (white) turns on. In addition, the CTS display indication is displayed on the multi-information display at the same time.

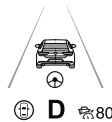

2. Adjust the vehicle speed to the desired setting using the accelerator pedal and press the RES switch up (SET+) or down (SET-) to start headway control.

4-146

The set speed is indicated on the display. At the same time, the CTS standby indication (white) changes to the CTS set indication (green).

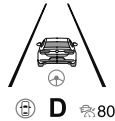

3. The headway control is operable when all of the conditions for it to operate are met, or the steering assist function is operable when all of the conditions for it to operate are met.

NOTE

- If a vehicle ahead is detected while travelling at a constant speed, the vehicle-ahead indication is displayed and headway control is performed. Additionally, when a vehicle ahead is no longer detected, the vehicle-ahead indication turns off and the system switches back to travel at constant speed.
- The lowest possible speed which can be set on the CTS is 30 km/h (19 mph).
- Headway control is not possible if the vehicle ahead is driving faster than your vehicle's set speed. Adjust the system to the desired vehicle speed using the accelerator pedal.
- When the ignition is switched OFF, the system status before it was turned off is maintained. For example, if the ignition is switched OFF with the CTS operable, the CTS remains operational the next time the ignition is switched ON.
- When the CTS switch is pressed until the system switches to the cruise standby indication (white) while the CTS is operating, the system switches to the cruise control function.
- When the CTS is operating, the Lane-keep Assist System (LAS), Distance & Speed Alert (DSA), and Smart Brake Support (SBS) also turns on automatically.
- When the CTS switch is pressed while the Mazda Radar Cruise Control (MRCC) or the Mazda Radar Cruise Control with Stop & Go function (MRCC with Stop & Go function) system is operating, the CTS operates. In addition, when the MRCC switch is pressed while the CTS is operating, the Mazda Radar Cruise Control (MRCC) or the Mazda Radar Cruise Control with Stop & Go function (MRCC with Stop & Go function) system operates.

Changing the set vehicle speed

(To accelerate/decelerate using the RES switch)

When the RES switch is pressed up (SET+), the vehicle accelerates and when the RES switch is pressed down (SET-), it decelerates.

- Press and release immediately: 1 km/h (1 mph)

When Driving

i-ACTIVSENSE

- Press and hold: 10 km/h (5 mph)

(To increase speed using accelerator pedal)

Depress the accelerator pedal and press the RES switch up (SET+) or down (SET-) at the desired speed. If the switch is not operated, the system returns to the set speed after you release your foot from the accelerator pedal.

NOTE

- The warnings and brake control do not operate while depressing the accelerator pedal.
- (Automatic transmission vehicle)
The vehicle speed setting can be changed by operating the RES switch during stop hold control.

Changing the distance between vehicles during headway control

The distance-between-vehicles can be set to 4 levels; Long, medium, short, and extremely short distance.

The distance-between-vehicles is set to a shorter distance by pressing the CANCEL switch down. The distance-between-vehicles is set to a longer distance by pressing the CANCEL switch up.

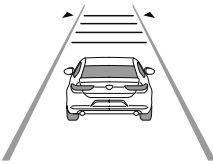
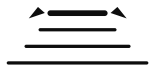
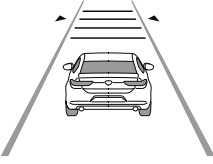
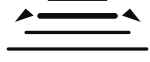
Distance-between-vehicles guideline (at 80 km/h (50 mph) vehicle speed)	Indication on display	
	Indication on multi-information display	Indication on active driving display*1
Long (about 50 m (164 ft))		
Medium (about 40 m (131 ft))		

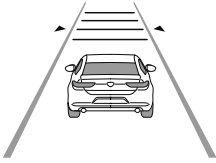
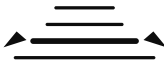
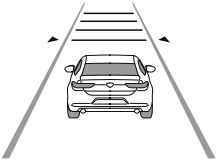
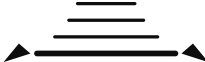
Distance-between-vehicles guideline (at 80 km/h (50 mph) vehicle speed)	Indication on display	
	Indication on multi-information display	Indication on active driving display*1
Short (about 30 m (98 ft))		
Extremely short (about 25 m (82 ft))		

*1 Displays a pop-up image when the CANCEL switch is operated.

NOTE

- The slower the vehicle speed, the shorter the distance between the vehicles.
- When the ignition is switched to ACC or OFF, the set distance-between-vehicles is taken over automatically even when the engine is started again.

The function is temporarily cancelled.

Headway control function

When the following operations are performed, the headway control function is temporarily cancelled and the CTS set indication (green) changes to the CTS standby indication (white) at the same time.

- The CANCEL switch is pressed one time.
- The brake pedal is depressed.
- **(Automatic transmission vehicle)**
The selector lever is in the P, N, or R position.

When Driving

i-ACTIVSENSE

- **(Manual transmission vehicle)**

The shift lever is in the R position.

In the following cases, the CTS cancel indication is displayed and a sound is activated one time.

- The DSC has operated.
- The Smart Brake Support (SBS) has operated.
- The vehicle is driven on a downslope for a long time.
- There is a problem with the system.
- The front radar sensor cannot detect target objects (during rain, fog, snow or other inclement weather conditions, or when the radiator grille is dirty).
- The parking brake is applied.
- Any of the doors is opened.
- The driver's seat belt is unfastened.
- **(Automatic transmission vehicle)**
The parking brake is automatically applied during stop hold control.
- **(Manual transmission vehicle)**

- The vehicle speed decreases below 25 km/h (15 mph).
- The shift lever is in the neutral position for a certain period of time.
- The clutch pedal is depressed for a certain period of time.
- The engine has stalled.

Steering assist function

If any of the following conditions occurs, the steering assist function is temporarily cancelled.

- White (yellow) lane lines cannot be detected or a vehicle ahead cannot be recognised.
- CANCEL switch is pressed.
- Your vehicle speed is more than about 60 km/h (37 mph).
- The brake pedal is depressed.
- The accelerator pedal is operated.
- The direction indicator lever is operated.
- The vehicle is making a sharp curve.
- The width of a lane is excessively narrow or wide.
- The vehicle crosses a lane line.
- **(Automatic transmission vehicle)**
The selector lever is in the P, N, or R position.

4-150

- **(Manual transmission vehicle)**
The shift lever is in the R position.

In the following cases, the CTS cancel indication is displayed and a sound is activated one time.

- The DSC has operated.
- The ABS/TCS/DSC is operating.
- The Smart Brake Support (SBS) has operated.
- The parking brake is applied.
- Any of the doors is opened.
- The driver's seat belt is unfastened.
- The driver takes his/her hands off the steering wheel.
- The vehicle is driven on a downslope for a long time.
- The steering wheel is operated abruptly.
- There is a problem with the system.
- The temperature in the Forward Sensing Camera (FSC) is high or low.
- The windscreen around the Forward Sensing Camera (FSC) is foggy.
- The windscreen around the Forward Sensing Camera (FSC) is blocked by an obstruction, causing poor forward visibility.
- The front radar sensor cannot detect target objects (during rain, fog, snow or other inclement weather conditions, or when the radiator grille is dirty).
- **(Automatic transmission vehicle)**
The parking brake is automatically applied during stop hold control.
- **(Manual transmission vehicle)**
The vehicle speed decreases below 25 km/h (15 mph).
- The shift lever is in the neutral position for a certain period of time.
- The clutch is depressed for a certain period of time.
- The engine has stalled.

NOTE

If you take your hands off the steering wheel (not holding the steering wheel), the warning sound is activated and an alert is indicated on the multi-information display and the active driving display.

When Driving

i-ACTIVSENSE

Multi-information display

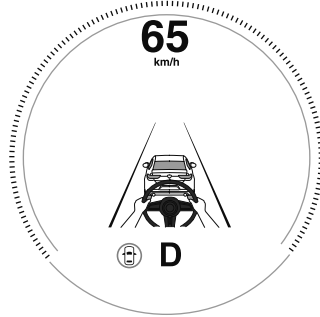

Active driving display



If the steering wheel is held lightly, or depending on the road conditions, the system determines that you have released the steering wheel (not holding the steering wheel) even if you are holding it, and an alert is indicated on the multi-information display and the active driving display.

To resume operation

If the CTS is temporarily cancelled, it will resume operation at the previously set speed by pressing the RES switch after all of the operation conditions have been met.

NOTE

- If the set speed is not indicated on the display, the system does not operate even if the RES switch is pressed.*
- After the operation, the steering assist operation may not operate for a period of 5 seconds at the most until the lane lines are detected or a vehicle ahead is recognised.*

Turning off

When the CTS switch is pressed while the CTS is operating, the CTS turns off.

4-152

▼ **Shift-up/Shift-down Request Display (Manual Transmission)**

The shift-up or shift-down request display might be displayed while the CTS is operating. When this occurs, shift gears because the gear position is not appropriate.

Request	Indication on display
Shift up	Shift Up to a Higher Gear
Shift down	Shift Down to a Lower Gear

NOTE

- If the gears are not shifted up even though the shift-up request indication is displayed, load will be applied to the engine and the CTS might be automatically cancelled or engine damage could occur.
- If the gears are not shifted down even though the shift-down request indication is displayed, the CTS might be automatically cancelled or engine stalling could occur.

▼ **Stop Hold Control (Automatic Transmission)**

While in headway control using the CTS, your vehicle will stop when a vehicle ahead stops. When the vehicle is stopped and the stop hold control operates, the CTS indicator light turns on.

HOLD

NOTE

- If the CTS is temporarily cancelled during stop hold control, the vehicle is held in its stopped position.

- The parking brake is automatically applied and the vehicle is held in its stopped position when 10 minutes or longer have passed since the stop hold control operated. When this occurs, the CTS is temporarily cancelled.
- If the i-stop operation conditions are met during stop hold control, the engine stops even though the brake pedal is not depressed.
Refer to i-stop on page 4-11.
- The brake lights turn on during stop hold control.

To resume driving

After the vehicle ahead starts moving while your vehicle is stopped under stop hold control, press the RES switch or depress the accelerator pedal to cancel the stop hold control and start driving.

NOTE

- When you resume driving by pressing the RES switch, your vehicle does not start moving until the distance between your vehicle and the vehicle ahead lengthens to the specified distance or farther.
- The engine restarts automatically when any of the actions to resume driving are performed while i-stop is operating.
- If the CTS is temporarily cancelled during stop hold control, you cannot resume driving by pressing the RES switch when there are no vehicles in front of your vehicle. Depress the accelerator pedal and resume driving the vehicle.

· If the vehicle ahead starts moving within 3 seconds after your vehicle is stopped by the stop hold control, headway control will continue even if you do not resume driving your vehicle, such as by depressing the accelerator pedal.

Vehicle departure information

If you do not resume driving within a few seconds after the vehicle ahead starts moving during stop hold control, the multi-information display vehicle-ahead indication flashes to urge the driver to resume driving. If you do not resume driving after the indicator light flashes, a sound is activated to urge you to resume driving.

Lane-keep Assist System (LAS)

▼ Lane-keep Assist System (LAS)

The LAS provides steering assistance to help the driver stay within the vehicle lane if the vehicle might be deviating.

The forward sensing camera (FSC) detects the white lines (yellow lines) of the vehicle lane in which the vehicle is travelling and if the system determines that the vehicle may deviate from its lane, it operates the electric power steering to assist the driver's steering operation. The system also alerts the driver by displaying an alert on the multi-information display.

Use the system when you drive the vehicle on roads with white (yellow) lines such as expressways and highways.

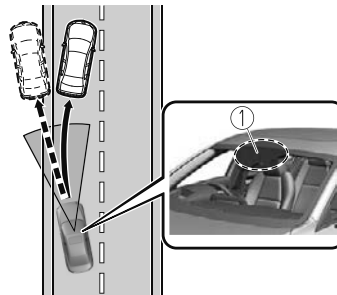

1. Forward sensing camera (FSC)

⚠ WARNING

Do not rely completely on the LAS:

➤ *The LAS is not an automated driving system. In addition, the system is not designed to compensate for a driver's lack of caution, and over-reliance on the system could lead to an accident.*

- *The functions of the LAS have limitations. Always stay on course using the steering wheel and drive with care.*
 - *Do not use the LAS under the following circumstances, otherwise it may result in an accident.*
 - *The vehicle is driven on slippery roads such as icy or snow-covered roads, and unpaved roads.*
 - *Tyres of a different specified size are used, such as a temporary spare tyre.*
 - *Tyres with insufficient tread are used.*
 - *The tyre pressures are not adjusted to the specified pressure.*
 - *The vehicle is being used to tow a camper or boat trailer.*
 - *Tyre chains are used.*
 - *The vehicle is driven on roads with lane lines other than white (yellow) lines, such as an expressway.*
- ⚠ CAUTION**
- Heed the following cautions so that the LAS can operate normally.*
- *Do not modify the vehicle's suspensions.*
 - *Always use wheels of the specified type and size for the front and rear wheels. Consult an expert repairer, we recommend an Authorised Mazda Repairer for tyre replacement.*
- NOTE**
- The system may not operate normally under the following conditions.*
- *The white (yellow) lane lines are less visible because of dirt or paint flaking.*
 - *White (yellow) lane lines are less visible because of bad weather (rain, fog, or snow).*
 - *The vehicle is driven on a temporary lane or section with a closed lane resulting from construction where there might be multiple white (yellow) lane lines, or they are interrupted.*
 - *The camera picks up an obscure line, such as a temporary line being used for construction, or because of shade, unmelted snow, or grooves filled with water.*
 - *The surrounding brightness suddenly changes such as when entering or exiting a tunnel.*
 - *Back-light is reflected off the road surface.*
 - *The road surface is wet and shiny after rain, or there are puddles on the road.*
 - *The width of a lane is excessively narrow.*
 - *The vehicle is driven on roads with tight curves.*
 - *Heavy luggage is loaded in the luggage compartment or on the rear seat causing the vehicle to tilt.*
 - *The vehicle is driven through a fork in the road or a junction.*
 - *The shade of a guardrail parallel to a white (yellow) lane line is cast on the road.*
 - *The illumination of the headlights is weakened because of dirt or the optical axis is deviated at night.*
 - *The road is excessively uneven.*
 - *The vehicle is shaken after hitting a road bump.*
 - *A vehicle in front of your vehicle is running near a white (yellow) lane line making it less visible.*
 - *The windscreen is dirty or foggy.*

i-ACTIVSENSE

- Strong light is directed from the front of the vehicle (such as sunlight, or headlights (high-beam) of on-coming vehicles).

▼ System Operation

When the ignition is switched ON, the i-ACTIVSENSE status symbol (warning/risk avoidance support system) (white) turns on and the system goes on standby.



NOTE

If the i-ACTIVSENSE status symbol (warning/risk avoidance support system) (white) does not turn on, the system is cancelled using the i-ACTIVSENSE switch or the personalisation feature.

Operation conditions

When all of the following conditions are met, the i-ACTIVSENSE status symbol (warning/risk avoidance support system) on the multi-information display changes from white to green and the system becomes operational.

- The ignition is switched ON.
- The vehicle speed is about 60 km/h (37 mph) or faster.
- The system detects white (yellow) lane lines.



NOTE

When the system does not detect a white (yellow) lane line on one side only, the system does not operate on the side that is not being detected.

When temporarily cancelling the system

The LAS goes on standby in the following cases: The LAS operation is automatically restored when the system's operation conditions are met.

- The system cannot detect white (yellow) lane lines.
- The vehicle speed is less than about 55 km/h (34 mph).
- The direction indicator lever is operated.
- The accelerator pedal is depressed abruptly.
- The TCS/DSC is operating.
- The DSC is turned off.
- The steering wheel is operated.
- The brake pedal is operated.

The function is temporarily stopped.

The LAS stops functioning in the following cases:

- The temperature in the forward sensing camera (FSC) is high or low.
- The windscreen around the forward sensing camera (FSC) is foggy.
- The windscreen around the forward sensing camera (FSC) is blocked by an obstruction, causing poor forward visibility.
- Strong light (such as sunlight, or headlights (high-beam) of on-coming vehicles) is directed at the forward sensing camera (FSC).

System malfunction

If there is a problem with the system, the i-ACTIVSENSE status symbol (warning/risk avoidance support system) (white) and the i-ACTIVSENSE warning indication/warning light on the multi-information display turns on and a message is indicated.

Refer to i-ACTIVSENSE Status Symbol (Warning/Risk Avoidance Support System) on page 4-84.

▼ Steering Wheel Operation Assist

When the system determines that the vehicle might be deviating from its lane, the steering wheel operation assist operates.

The system notifies the driver of the direction in which the system provided steering wheel operation assistance on the multi-information display.

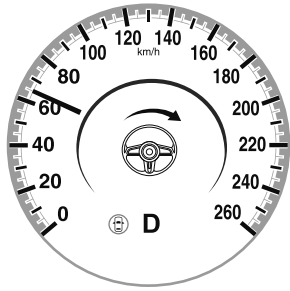

NOTE

When the driver operates the steering wheel while the steering wheel operation assist is operating, the steering wheel operation assistance is cancelled.

▼ System Cancellation

The LAS can be set to inoperable.

- **(If only the LAS is turned off)**
Refer to the Settings section in the MZD Connect Owner's Manual.
- **(If the LAS is turned off by operating the i-ACTIVSENSE switch)**
Refer to i-ACTIVSENSE Switch on page 4-85.

NOTE

When the ignition is switched OFF, the system status before it was turned off is maintained. For example, if the ignition is switched OFF with the LAS operable, the LAS remains operational the next time the ignition is switched ON.

Intelligent Speed Assistance (ISA)

▼ Intelligent Speed Assistance (ISA)

The ISA is a function which keeps the vehicle speed below the speed limit set from a speed limit sign or an optionally set speed limit. The speed limit can be set between 30 and 200 km/h (19-125 mph), and if the vehicle speed exceeds the set speed limit while driving on steep slopes, the system notifies the driver using the display and a warning sound.

The ISA recognises a speed limit sign based on the Traffic Sign Recognition System (TSR) or the navigation system information.

Refer to Traffic Sign Recognition System (TSR) on page 4-101.

! WARNING

Always turn off the system when changing drivers:

If the driver is changed and the new driver is unaware of the ISA function, the vehicle may not accelerate when the driver depresses the accelerator pedal, leading to an accident.

Depending on the weather conditions or problems with traffic signs, a traffic sign may not be recognised or a traffic sign different from the actual traffic sign may be displayed. Always make it your responsibility as a driver to check the actual traffic signs. Otherwise, it could result in an accident.

NOTE

The ISA operates only when the navigation system's SD card (Mazda genuine) is inserted.

The system consists of the ISA display and the speed limiter switch on the steering wheel.

Multi-information display (Basic display)

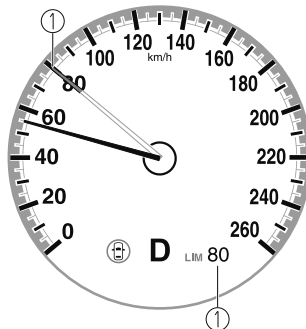

1. set vehicle speed

Multi-information display (i-ACTIVSENSE display)

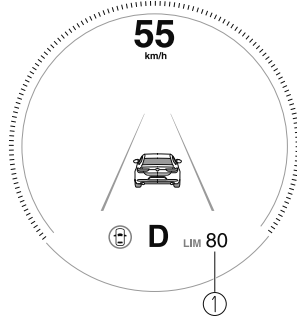

1. set vehicle speed

Active driving display

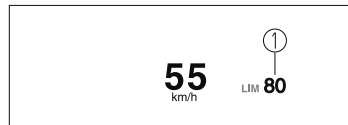

1. set vehicle speed

Speed limiter switch

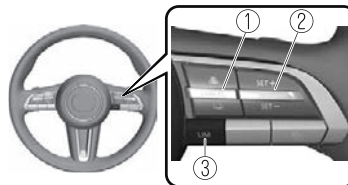

1. CANCEL switch
2. RES switch
3. LIM switch

When Driving

i-ACTIVSENSE

▼ **Intelligent Speed Assistance (ISA)
Standby Indication (White)/
Intelligent Speed Assistance (ISA)
Set Indication (Green)**

ISA standby indication (white)

The indication is displayed in white when the LIM switch is pressed and the ISA is activated.

LIM

ISA set indication (green)

The indication is displayed in green when a speed has been set.

LIM

▼ **Intelligent Speed Assistance (ISA) Display**

The setting status of the ISA is displayed in the active driving display or the display in the instrument cluster.

Status	Indication on multi-information display/ active driving display	Explanation
Stand-by display	LIM ----	Displays when the speed limiter switch is operated and the system is turned on. Turns off when the system is turned off.
Setting display	LIM 80	Displays when the SET- or SET+ switch is operated and the speed is set.
Cancel display	LIM 80	Displays when any of the following operations is done and the system is temporarily cancelled. <ul style="list-style-type: none"> • CANCEL switch is operated • Accelerator pedal is strongly depressed • Any door is opened • The driver's seat belt is unfastened
Warning display	LIM 80	If the vehicle speed exceeds the set speed by about 5 km/h (3 mph) or more, the ISA display flashes. The display flashes until the vehicle speed decreases to the set speed or less. A warning beep is activated at the same time as the warning display. Refer to Speed Limiter Warning Beep on page 7-41.

▼ **Activation/Deactivation**

NOTE

When the ignition is switched off, the system status before it was turned off is maintained.

For example, if the ignition is switched off while the ISA is operating, the system will be operable when the ignition is switched ON the next time.

Activation

Press the LIM switch to activation the system. The ISA screen is displayed, and the ISA standby indication displays in white.

Deactivation

Press the LIM switch again to deactivation the system. The ISA screen is no longer displayed and the ISA indication does not display.

▼ **Setting the System**



Always verify the safety of the surrounding area when setting the ISA:

If the speed is set lower than the current vehicle speed, the vehicle speed is decreased to the set speed. Verify the safety of the surrounding area and keep a safer distance between vehicles ahead and behind you.

NOTE

- *The system is temporarily cancelled when the vehicle is accelerated by depressing the accelerator pedal strongly, however, it resumes when the vehicle speed decreases to the set speed or less.*
 - *The vehicle speed may exceed the set speed on a down slope.*
 - *In the following cases, the system cannot be set.*
 - *Any door is open.*
 - *The driver's seat belt is unfastened.*
 - *The ISA setting can be changed to MANUAL, or OFF.*
- Refer to the Settings section in the MZD Connect Owner's Manual.*

How to set the speed limit using the SET switch

1. Press the LIM switch to turn the system on.
2. Press the RES switch up (SET+) or down (SET-) to set the speed. When the current vehicle speed is 30 km/h (19 mph) or more, the speed is set to the current vehicle speed. When the current vehicle speed is less than 30 km/h (19 mph), the speed is set to 30 km/h (19 mph).
3. To increase the set speed, press the RES switch up (SET+) continuously. The set speed can be adjusted in 10 km/h (5 mph) increments. The set speed can also be adjusted in about 1 km/h (1 mph) increments by pressing the RES switch up (SET+) momentary. For example, the set speed increases about 4 km/h (4 mph) by pressing the RES switch up (SET+) switch 4 times.
4. To decrease the set speed, press the RES switch up (SET-) continuously. The set speed can be adjusted in 10 km/h (5 mph) increments. The set speed can also be adjusted in about 1 km/h (1 mph) increments by pressing the RES switch up (SET-) momentary. For example, the set speed decreases about 4 km/h (4 mph) by pressing the RES switch up (SET-) 4 times.

NOTE

- *When the vehicle set speed is displayed in the active driving display/instrument cluster, press the RES switch to set the displayed vehicle speed. If speed limit sign is not displayed.*

Manually setting the vehicle speed limit from a speed limit sign

1. Press the LIM switch to turn the system on.
2. Press the RES switch while the ISA set indication is displayed on the active driving display/instrument cluster to set the vehicle speed limit to the speed of the displayed speed limit sign.

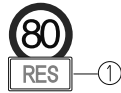

1. Speed limit sign setting indication

NOTE

- The speed limit cannot be set from the speed limit sign when the speed limit sign indication is displayed in gray.

Excessive speed range setting

The range of speed that can exceed the set speed can be changed.

Refer to the Settings section in the MZD Connect Owner's Manual.

- + 0: The vehicle speed is restricted at the set speed.
- + 5: If the vehicle speed exceeds the set speed by 5 km/h (3mph), the vehicle speed is restricted.
- + 10: If the vehicle speed exceeds the set speed by 10 km/h (5 mph), the vehicle speed is restricted.

▼ Temporarily Cancelling the System

The system is temporarily cancelled (stand-by status) when any of the following operations is done while the ISA is displayed.

- CANCEL switch is pressed
- Accelerator pedal is strongly depressed
- Any door is opened
- The driver's seat belt is unfastened

NOTE

- The set speed can be set by pressing the RES switch up (SET+) or down (SET-) while the system is in stand-by status.
- The ISA is not cancelled by depressing the brake pedal.

Smart Brake Support (SBS)

▼ Smart Brake Support (SBS)

The SBS alerts the driver of a possible collision using the warning indications in the display and a warning sound if the front radar sensor and Forward Sensing Camera (FSC) determine that there is the possibility of a collision with a vehicle ahead, pedestrian, or a bicycle.

Furthermore, if a collision is unavoidable, the automatic brake control is performed to reduce damage in the event of a collision. In addition, when the driver depresses the brake pedal, the brakes are applied firmly and quickly to assist.

(Vehicles with Driver Monitoring (DM))

When the SBS determines that the driver is not paying attention to the road using the driver monitoring camera and it determines that there is the possibility of a collision with an obstruction, the SBS activates the collision warning earlier than normal.

WARNING

Do not rely completely on the SBS:

The SBS is only designed to reduce damage in the event of a collision.

The ability to detect obstructions is limited depending on the obstructions, weather conditions, or traffic conditions. Over reliance on the system leading to the accelerator pedal or brake pedal being mistakenly operated could result in an accident.

4-164

CAUTION

In the following cases, turn the system off to prevent an unexpected operation.

- *The vehicle is being towed or when towing another vehicle.*
- *The vehicle is on a chassis roller.*
- *When driving on rough roads such as in areas of dense grass or off-road.*
See the next page on how to turn off the system.
Refer to Stopping the Smart Brake Support (SBS) System Operation on page 4-166.

Operation conditions

The SBS operates when all of the following conditions are met.

- The ignition is switched ON.
- The SBS is on.
- The i-ACTIVSENSE warning indication/warning light is not turned on.
- **(Object is vehicle ahead)**
The vehicle speed is about 4 km/h (2 mph) or higher.
- **(Object is a pedestrian or bicycle)**
The vehicle speed is between about 10 to 80 km/h (6.2 to 50 mph).
- The DSC does not operate.

NOTE

- *Under the following conditions, the SBS may not operate.*
 - *If there is the possibility of hitting only a part of a vehicle or obstruction ahead.*
 - *You are driving your vehicle at the same speed as the vehicle ahead.*

- When the driver deliberately performs driving operations (accelerator operation, steering wheel operation).
- The accelerator pedal is depressed abruptly.
- The brake pedal is being depressed.
- The steering wheel is being operated.
- The selector lever is being shifted.
- The direction indicator lever is being operated.
- When warnings and messages, such as a dirty windscreen, related to the Forward Sensing Camera (FSC) or front radar sensor are being displayed on the multi-information display.
- The SBS may operate under the following conditions.
 - There is an object in the road at the entrance to a curve (including guardrails and snow banks).
 - Passing an approaching vehicle while rounding a curve.
 - When crossing a narrow bridge, and passing through low gates, narrow gates, car washing machines, or tunnels.
 - When passing through a toll gate.
 - When entering an underground parking area.
 - There is a metal object, bump, or a protruding object on the road.
 - If you suddenly come close to a vehicle ahead.
 - There is an animal, wall, or tree.
- Notifies the driver with a warning indication on the multi-information display and the active driving display (vehicles with active driving display) while the system is operating.
- If a malfunction is detected or the system temporarily stops the function due to dirty sensors (such as radar sensor or Forward Sensing Camera (FSC)), the i-ACTIVSENSE warning indication/warning light turns on and a message is displayed on the multi-information display and active driving display.
- On a manual transmission vehicle, the engine stops if the clutch pedal is not depressed when the vehicle is stopped by the SBS brake operation.
- If the vehicle is stopped by the SBS brake operation and the brake pedal is not depressed, the SBS brake is automatically released after about 2 seconds.

▼ Collision Warning

When there is a possibility of a collision with a vehicle ahead, the collision warning sound is activated continuously and a warning is displayed on the multi-information display and the active driving display.

Multi-information display

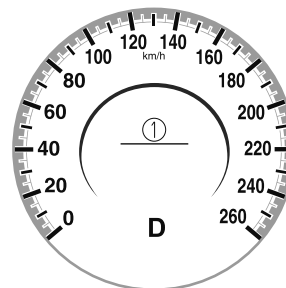

1. "BRAKE!" message is displayed

Active driving display

①

1. "BRAKE!" message is displayed

NOTE

- The collision warning sound is activated intermittently while the SBS brake or brake assist (SBS brake assist) is operating.
- The operation distance and volume of the collision warning can be changed. Refer to the Settings section in the MZD Connect Owner's Manual.

▼ Stopping the Smart Brake Support (SBS) System Operation

The SBS can be changed to inoperable.

- **(If only the SBS is turned off)**
Refer to the Settings section in the MZD Connect Owner's Manual.
- **(If the SBS is turned off by operating the i-ACTIVSENSE switch)**
Refer to i-ACTIVSENSE Switch on page 4-85.



When turning off the SBS, the SBS OFF indicator light turns on.

NOTE

If the engine is stopped with the SBS turned off, the SBS becomes operational when the engine is started the next time.

4-166 *Some models.

Smart Brake Support [Rear] (SBS-R)*

▼ Smart Brake Support [Rear] (SBS-R)

The SBS-R is a system which is designed to reduce damage in the event of a collision by operating the brake control (SBS brake) when the system's sensors detect an obstruction at the rear of the vehicle while driving at a speed of about 2 to 8 km/h (2 to 4 mph) and the system determines that a collision is unavoidable.

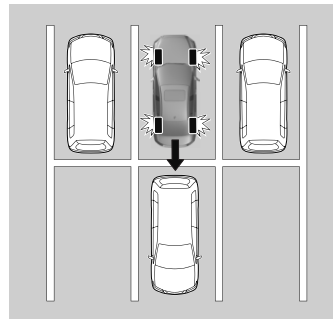

⚠ WARNING

Do not rely completely on the SBS-R system:

- The SBS-R system is only designed to reduce damage in the event of a collision. Over reliance on the system leading to the accelerator pedal or brake pedal being mistakenly operated could result in an accident.
- To assure the correct operation of the SBS-R, heed the following cautions.

- Do not apply a sticker to a rear ultrasonic sensor and rear camera. Otherwise, the rear ultrasonic sensor and rear camera may not be able to detect vehicles or obstructions which could result in an accident.
- Do not disassemble a rear ultrasonic sensor and rear camera.
- If cracks or damage caused by flying gravel or debris is visible around a rear ultrasonic sensor and rear camera, stop using the SBS-R system immediately and have your vehicle inspected by an expert repairer, we recommend an Authorised Mazda Repairer. If the vehicle continues to be driven with cracks or scratch marks left around an ultrasonic sensor, the system may operate unnecessarily and cause an unexpected accident. Refer to *Stopping the Smart Brake Support [Rear] (SBS-R) System Operation* on page 4-170.
- Consult an expert repairer, we recommend an Authorised Mazda Repairer for rear bumper replacement.

Do not modify the suspension:

If the vehicle height or inclination is changed, the SBS-R system may not operate correctly because it cannot detect obstructions correctly.

Do not apply a strong force to a rear ultrasonic sensor and rear camera:

When washing the vehicle, do not spray highly pressurised water against a rear ultrasonic sensor and rear camera, or rub it strongly. In addition, do not hit the rear bumper forcefully when loading and unloading cargo. Otherwise, the sensors may not detect obstructions correctly which could cause the SBS-R system to not operate normally, or it could operate unnecessarily.

CAUTION

- When driving off-road in areas where there is grass or foliage, it is recommended that the SBS-R system be turned off.
- Always use tyres of the specified size and the same manufacturer, brand, and tread pattern on all 4 wheels. In addition, do not use tyres with significantly different wear patterns on the same vehicle. Otherwise, the SBS-R system may not operate normally.
- If ice or snow is stuck on the rear ultrasonic sensor and rear camera they may not be able to detect obstructions correctly depending on the conditions. In such cases, the system may not be able to perform controls correctly. Always drive carefully and pay attention to the rear of the vehicle.

NOTE

- The vehicle posture changes depending on the accelerator pedal, brake pedal and steering wheel operations, which could make it difficult for the system to recognise an obstruction, or it could facilitate unnecessary detection. In such cases, the SBS-R may or may not operate.
- The SBS-R system will operate under the following conditions.
 - The engine is running.
 - The shift lever (manual transmission vehicle) or the selector lever (automatic transmission vehicle) is in the R (reverse) position.
 - The slope is less than 5 %.
 - i-ACTIVSENSE warning indication/warning light is not displayed in the multi-information display.
 - The vehicle speed is between about 2 to 8 km/h (2 to 4 mph).
 - The SBS-R is not turned off.
 - The DSC is not malfunctioning.
- In the following cases, the rear ultrasonic sensor and rear camera cannot detect obstructions and the SBS-R may not operate.
 - The height of the obstruction is low such as low walls or trucks with low loading platforms.
 - The height of the obstruction is high such as trucks with high loading platforms.
 - The obstruction is small.
 - The obstruction is thin such as a signpost.
 - The surface of the obstruction is not pointed vertically relative to the vehicle.
- The obstruction is soft such as a hanging curtain or snow stuck to a vehicle.
- The obstruction is shaped irregularly.
- The obstruction is extremely close.
- In the following cases, the rear ultrasonic sensor and rear camera cannot detect obstructions correctly and the SBS-R may not operate.
 - Something is stuck on the bumper near a rear ultrasonic sensor.
 - The brake or accelerator pedal is operated.
 - There is another obstruction near one obstruction.
 - During inclement weather such as rain, fog and snow.
 - High or low humidity.
 - High or low temperatures
 - Strong winds.
 - The path of travel is not flat.
 - Heavy luggage is loaded in the luggage compartment or on the rear seat.
 - Objects such as a wireless aerial, fog light, or illuminated number plate is installed near a rear ultrasonic sensor.
 - The orientation of a rear ultrasonic sensor has deviated for reasons such as a collision.
 - The vehicle is affected by other sound waves such as the horn, engine noise, ultrasonic sensor of another vehicle.
- In the following cases, a rear ultrasonic sensor and rear camera may detect something as a target obstruction which could cause the SBS-R system to operate.
 - Driving on a steep slope.
 - Wheel blocks.

- Hanging curtains, gate poles such as at toll gates and railroad crossing.
 - When travelling near objects such as foliage, barriers, vehicles, walls, and fences along a road.
 - When driving off-road in areas where there is grass and forage.
 - When passing through low gates, narrow gates, car washing machines, and tunnels.
 - A trailer is connected.
 - A bright light source such as sunlight hits the rear camera.
 - The surroundings are dark.
 - An exterior accessory such as a bicycle carrier is installed around the rear sonar.
- **(Manual transmission)**
If the vehicle is stopped by the SBS-R operation and the clutch pedal is not depressed, the engine stops.
- When the system operates, the user is notified by the multi-information display.
 - The collision warning beep sounds intermittently while the SBS-R brake is operating.
 - If the vehicle is stopped by the SBS-R operation and the brake pedal is not depressed, displaying in meter “Emergency Braking Activated. Depress Brake Pedal to Hold Stop”, after about 2 seconds and the SBS-R brake is automatically released.
 - If a Mazda genuine trailer hitch is used, the SBS-R is automatically turned off.

▼ Collision Warning

If there is a possibility of a collision, the collision warning sound is activated continuously and a warning is displayed on the active driving display and the multi-information display.

Multi-information display

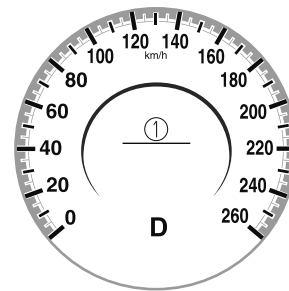

1. “BRAKE!” message is displayed

Active driving display

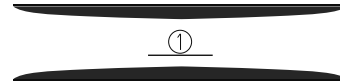

1. “BRAKE!” message is displayed

When Driving

i-ACTIVSENSE

▼ Stopping the Smart Brake Support [Rear] (SBS-R) System Operation

The SBS-R can be changed to inoperable.

- (If only the SBS-R is turned off)
Refer to the Settings section in the MZD Connect Owner's Manual.
- (If the SBS-R is turned off by operating the i-ACTIVSENSE switch)
Refer to i-ACTIVSENSE Switch on page 4-85.

When turning off the SBS-R, the SBS OFF indicator light turns on.



When the engine is restarted, the system becomes operational.

NOTE

When the SCB-R system is set to inoperable, Smart Brake Support [Rear Crossing] (SBS-RC) are also set to inoperable.

Smart Brake Support [Rear Crossing] (SBS-RC)*

▼ Smart Brake Support [Rear Crossing] (SBS-RC)

The SBS-RC is a system designed to assist the driver in avoiding collisions and to reduce damage in the event of a collision by applying the brakes if there is the possibility of collision with a vehicle approaching from the rear while you are reversing out of parking space.

The SBS-RC system detects vehicles approaching from the rear left and right sides of the vehicle, and the rear of the vehicle while the vehicle is being reversed out of a parking space, the system reduces damage in the event of a collision by operating the brake control when the system determines that a collision is unavoidable.

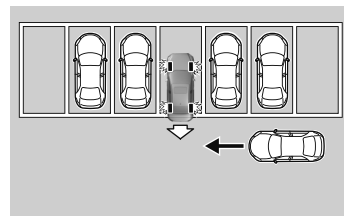

SBS-RC operation

1. The SBS-RC system operates when the shift lever (manual transmission) or the selector lever (automatic transmission) is shifted to the reverse (R) position.

4-170 *Some models.

2. If there is the possibility of a collision with an approaching vehicle, the SBS-RC system applies brake and displays “BRAKE!” on the active driving display and the multi-information display.

⚠ WARNING

Always check the surrounding area visually before actually putting the vehicle in reverse:

The system is only designed to assist you in backing out of the lot when putting the vehicle in reverse. Due to certain limitations with the operation of this system, the SBS-RC system may not operate brake or it might be delayed even though a vehicle is behind your vehicle. Always make it your responsibility as a driver to check the rear.

Do not rely completely on the SBS-RC system:

- The SBS-RC system is only designed to reduce damage in the event of a collision. Over reliance on the system leading to the accelerator pedal or brake pedal being mistakenly operated could result in an accident.
- The SBS-RC system operates in response to a vehicle. The system does not operate in response to obstructions such as a wall, pedestrians, 2-wheeled vehicles, or animals.

To assure the correct operation of the SBS-RC, heed the following cautions.

- Do not apply a sticker to a rear radar and rear camera. Otherwise, the rear radar and rear camera may not be able to detect vehicles or obstructions which could result in an accident.
- Do not disassemble a rear radar and rear camera.
- If cracks or damage caused by flying gravel or debris is visible around a rear radar and rear camera, stop using the SBS-RC system immediately and have your vehicle inspected by an expert repairer, we recommend an Authorised Mazda Repairer. If the vehicle continues to be driven with cracks or scratch marks left around an ultrasonic sensor, the system may operate unnecessarily and cause an unexpected accident. Refer to Stopping the Smart Brake Support [Rear Crossing] (SBS-RC) System Operation on page 4-174.
- Consult an expert repairer, we recommend an Authorised Mazda Repairer for rear bumper replacement.

Do not modify the suspension:

If the vehicle height or inclination is changed, the SBS-RC system may not operate correctly because it cannot detect obstructions correctly.

i-ACTIVSENSE

Do not apply a strong force to a rear radar and rear camera:

When washing the vehicle, do not spray highly pressurised water against a rear radar and rear camera, or rub it strongly. In addition, do not hit the rear bumper forcefully when loading and unloading cargo. Otherwise, the sensors may not detect obstructions correctly which could cause the SBS-RC system to not operate normally, or it could operate unnecessarily.

NOTE

- The SBS-RC system will operate under the following conditions.
 - The engine is running.
 - The shift lever (manual transmission vehicle) or the selector lever (automatic transmission vehicle) is in the R (reverse) position.
 - i-ACTIVSENSE warning indication/warning light is not displayed in the multi-information display.
 - The vehicle speed is under about 10 km/h (6 mph).
 - The vehicle speed of an approaching vehicle is about 3 km/h (2 mph) or faster.
 - The SBS-R is not turned off.
 - The DSC is not malfunctioning.
- In the following cases, the i-ACTIVSENSE warning indication/warning light turns on and operation of the system is stopped. If the i-ACTIVSENSE warning indication/warning light remains illuminated, have the vehicle inspected at an expert repairer, we recommend an Authorised Mazda Repairer as soon as possible.

- Some problem with the system including the SBS-RC system.
- A large deviation in the installation position of a rear side radar sensor on the vehicle has occurred.
- There is a large accumulation of snow or ice on the rear bumper near a rear side radar sensor.
- Driving on snow-covered roads for long periods.
- The temperature near the radar sensors becomes extremely hot due to driving for long periods on slopes during the summer.
- The battery voltage has decreased.
- Under the following conditions, the rear side radar sensor cannot detect target objects or it may be difficult to detect them.
 - The rear side radar sensor detection area is obstructed by a nearby wall or parked vehicle. (Reverse the vehicle to a position where the radar sensor detection area is no longer obstructed.)

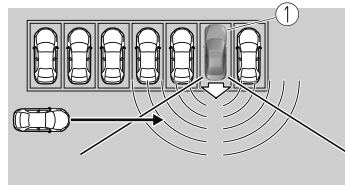

1. Your vehicle

- A vehicle is approaching directly from the rear of your vehicle.

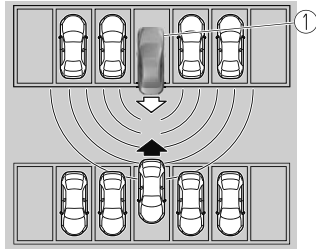

1. Your vehicle

- The vehicle is parked on a slant.

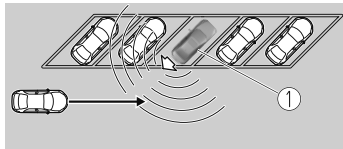

1. Your vehicle

- A vehicle is approaching from the opposite direction on a steep gradient.

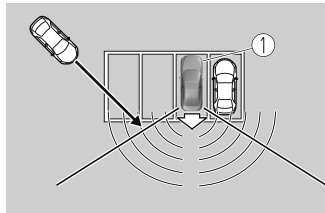

1. Your vehicle

- Directly after the SBS-RC system becomes operable using the personalisation feature.
- Radio wave interference from a radar sensor equipped on a nearby parked vehicle.

- Turn off the SBS-RC system while pulling a trailer or while an accessory such as a bicycle carrier is installed to the rear of the vehicle. Otherwise, the radio waves emitted by the radar will be blocked causing the system to not operate normally.
- In the following cases, a rear radar and rear camera may detect something as a target obstruction which could cause the SBS-RC system to operate.
 - Hanging curtains, gate poles such as at toll gates and railroad crossing.
 - When travelling near objects such as foliage, barriers, vehicles, walls, and fences along a road.
 - When driving off-road in areas where there is grass and forage.
 - When passing through low gates, narrow gates, car washing machines, and tunnels.
 - A trailer is connected.
 - A bright light source such as sunlight hits the rear camera.
 - The surroundings are dark.
- **(Manual transmission)**
If the vehicle is stopped by the SBS-RC operation and the clutch pedal is not depressed, the engine stops.
- When the system operates, the user is notified by the multi-information display.
- The collision warning beep sounds intermittently while the SBS-RC brake is operating.

i-ACTIVSENSE

- If the vehicle is stopped by the SBS-RC operation and the brake pedal is not depressed, displaying in meter “Emergency Braking Activated. Depress Brake Pedal to Hold Stop”, after about 2 seconds and the SBS-RC brake is automatically released.
- If a Mazda genuine trailer hitch is used, the SBS-RC is automatically turned off.

▼ Collision Warning

If there is a possibility of a collision, the collision warning sound is activated continuously and a warning is displayed on the active driving display and the multi-information display.

Multi-information display

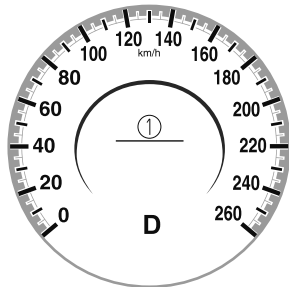

1. “BRAKE!” message is displayed

Active driving display

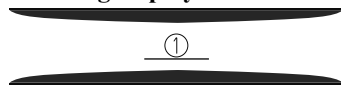

1. “BRAKE!” message is displayed

▼ Stopping the Smart Brake Support [Rear Crossing] (SBS-RC) System Operation

The SBS-RC can be changed to inoperable.

- **(If only the SBS-RC is turned off)**
Refer to the Settings section in the MZD Connect Owner's Manual.
- **(If the SBS-RC is turned off by operating the i-ACTIVSENSE switch)**
Refer to i-ACTIVSENSE Switch on page 4-85.

When turning off the SBS-RC, the SBS OFF indicator light turns on.



When the engine is restarted, the system becomes operational.

NOTE

When the SCB-RC system is set to inoperable, Smart Brake Support [Rear] (SBS-R) are also set to inoperable.

360° View Monitor*

▼ 360° View Monitor

The 360°View Monitor consists of the following functions which assist the driver in checking the area surrounding the vehicle using various indications in the centre display and a warning sound while the vehicle is being driven at low speeds or while parking.

- **Top view**

The top view displays an image of the vehicle from directly above on the centre display by combining the images taken from the 4 cameras set on all sides of the vehicle. The top view displays on the left side of the screen when the front view or rear view screen is being displayed. The top view assists the driver in checking the area surrounding the vehicle when the vehicle is moving forward or in reverse.

- **Front view/front wide view**

The image from the front of the vehicle is displayed on the centre display. The view from the front assists the driver in checking the front of the vehicle by displaying guide lines on the displayed image taken from the front of the vehicle.

- **Side view**

The images taken from the front left and right sides of the vehicle are displayed on the centre display.

The side view assists the driver in checking the front sides of the vehicle by displaying guide lines on the displayed image taken from the front left and right sides of the vehicle.

- **Rear view/rear wide view**

The image from the rear of the vehicle is displayed on the centre display.

The image from the rear assists the driver in checking the rear of the vehicle by displaying guide lines on the displayed image taken from the rear of the vehicle.

- **Parking sensor**

If there are any obstructions near the vehicle while the top view/side view is displayed, an obstruction detection indication turns on around the bumper in the centre display.

The parking sensors use ultrasonic sensors to detect obstructions around the vehicle when the vehicle is driven at low speeds, such as during garage or parallel parking, and notifies the driver of the approximate distance from the vehicle to the surrounding obstruction using sound and an obstruction detection indication. Refer to Parking Sensor System on page 4-236.

- **Front Cross Traffic Alert (FCTA)**

If there is the possibility of a collision with an approaching vehicle while the front view/front wide view/side view is displayed, a warning is displayed on the centre display.

The Front Cross Traffic Alert (FCTA) is designed to assist the driver in checking both sides of the vehicle when the vehicle starts to drive at an intersection. Refer to Front Cross Traffic Alert (FCTA) on page 4-113.

*Some models. **4-175**

· **Rear Cross Traffic Alert (RCTA)**

If there is the possibility of a collision with an approaching vehicle while the rear view/rear wide view is displayed, a warning is displayed on the centre display.

The Rear Cross Traffic Alert (RCTA) uses rear side radar sensor to detect vehicles approaching from the rear left and right sides of the vehicle, and it assists the driver in checking the rear of the vehicle while reversing by flashing the Blind Spot Monitoring (BSM) warning lights and activating the warning sound.

Refer to Rear Cross Traffic Alert (RCTA) on page 4-116.

360°View Monitor Range

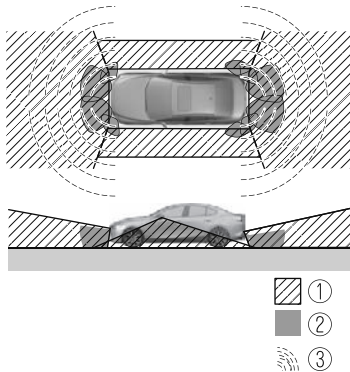

1. Cameras
2. Ultrasonic sensors
3. Front/Rear side radar sensors

WARNING

Always confirm the safety of the area around the vehicle with the mirrors and directly with your eyes when driving:

The 360°View Monitor is an auxiliary device which assists the driver in checking the safety of the area around the vehicle.

The shooting range of the cameras and detection range of the sensors are limited. For example, the areas in black at the front and rear of the vehicle image and the seams where each of the camera images merge are blind spots where an obstruction may not be visible. In addition, the extended vehicle width lines and projected vehicle path lines are only to be used as references, and the images on the screen may differ from the actual conditions.

CAUTION

- Do not use the 360°View Monitor under any of the following conditions.
 - Icy or snow-covered roads.
 - Tyre chains or a temporary spare tyre is installed.
 - The front doors or the rear doors is not fully closed.
 - The vehicle is on a road incline.
 - The door mirrors are retracted.
- Do not hit the front/rear camera, front/rear bumper, and door mirrors forcefully. The camera position or installation angle may shift.
- The cameras are of a waterproof structure. Do not disassemble, modify, or remove a camera.

- *The camera cover is made of hard plastic, therefore do not apply oil film remover, organic solvents, wax, or coating agents. If any such agent gets on the camera cover, wipe it off using a soft cloth immediately.*
- *Do not rub the camera lens forcefully, or clean it with an abrasive or hard brush. Otherwise, it could scratch the camera lens and negatively affect the images.*
- *Consult an Authorised Mazda Repairer for repair, painting, or replacement of the front/rear camera, front/rear bumper and door mirrors.*
- *Heed the following cautions to assure that the 360°View Monitor operates normally.*
 - *Do not modify the vehicle suspensions or lower/raise the vehicle body, or both.*
 - *Always use wheels of the specified type and size for the front and rear wheels. Consult an Authorised Mazda Repairer for tyre replacement.*
- *When the display is cold, images may leave trails or the screen might be darker than usual, making it difficult to check the vehicle surroundings. Always confirm the safety at the front and around the vehicle visually when driving.*
- *The method for parking/stopping the vehicle using the 360°View Monitor differs depending on the road circumstances/conditions and the vehicle conditions. When and how much you turn the steering wheel will differ depending on the situation, , therefore always check the vehicle surroundings directly with your eyes while using the system.*

Also, before using the system, always make sure that the vehicle can be parked/stopped in the parking/stopping space.

NOTE

- *If there are water droplets, snow, or mud on the camera lens, wipe it off using a soft cloth. If the camera lens is especially dirty, wash it off with mild detergent.*
- *If the camera lens is touched or there is any dirt on it, it could affect the screen image. Wipe the lens using a soft cloth.*
- *If the area where the camera is installed, such as the front/rear bumper or door mirrors, has been damaged in a vehicle accident, the camera (position, installation angle) may have shifted. Always consult an Authorised Mazda Repairer to have the vehicle inspected.*
- *If the camera is subjected to excessive changes in temperature such as by pouring hot water on the camera during cold weather, the 360°View Monitor may not operate normally.*
- *If the battery voltage is low, the screen might be temporarily difficult to view, however, this does not indicate a problem.*
- *The 360°View Monitor has limitations. Objects under the bumper or near both ends of the bumper cannot be displayed.*
- *Obstructions above the upper image range of the camera are not displayed.*
- *Under the following conditions, the screen might be difficult to view, however this does not indicate a problem.*
 - *The temperature near the lens is high/low.*

When Driving

i-ACTIVSENSE

- *Rainy conditions, water droplets on the camera, or high humidity.*
- *Mud or foreign matter near the camera.*
- *Extremely bright light such as sunlight or headlights hitting the camera lens directly.*
- *The surroundings are illuminated by vehicle lights, fluorescent lights, or LED lights (Display may flicker).*
- *Extremely small dark or white dots appear on the screen (dots may flicker).*
- *Because the 360°View Monitor camera uses a special lens, the distance displayed on the screen differs from the actual distance.*
- *Obstructions displayed on the screen may appear differently than in actuality. (Obstructions may appear fallen, larger, or longer than they actually are.)*
- *Do not apply stickers to a camera or the area around it. In addition, do not install accessories or an illuminated number/character number plate to the area around a camera. Otherwise, the camera may not correctly display the surrounding conditions.*
- ***Free/open source software information***
This product includes free/open sources. Information about the licensing and source code is available at the following URL.
<https://www.denso.com/global/en/opensource/svss/mazda/>

4-178

▼ **Types of Images Displayed on the Screen**

Top view/Front view

Displays the image of the area around the vehicle and the vehicle front.

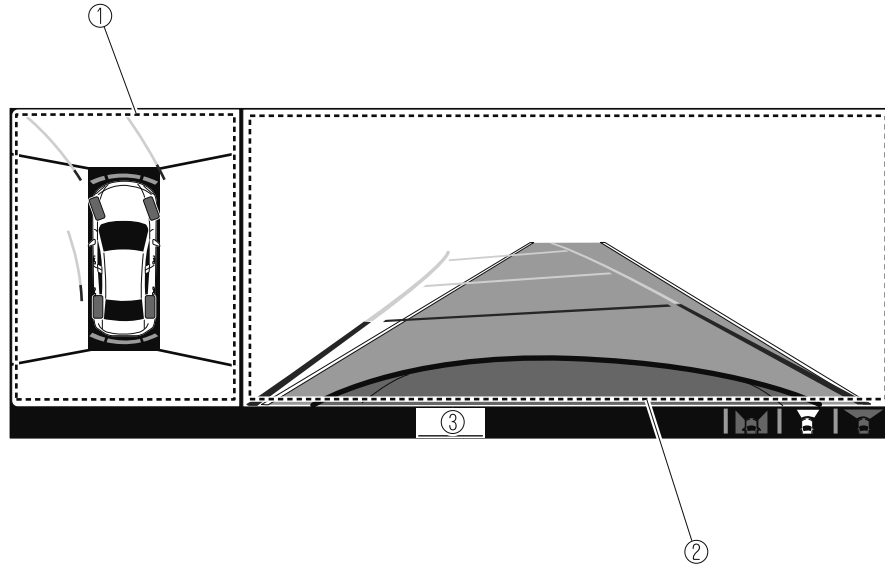

1. Top view screen
2. Front view screen
3. “Check surroundings for safety.” message is displayed

When Driving

i-ACTIVSENSE

Top view/Front wide view

Displays the image of the area around the vehicle and the front of the vehicle (wide-area).

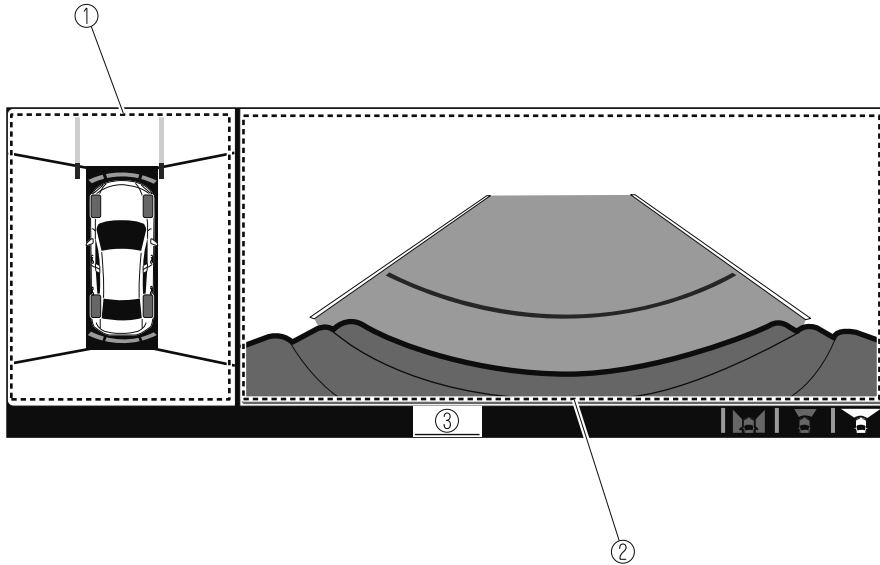

1. Top view screen
2. Front wide view screen
3. “Check surroundings for safety.” message is displayed

Side view

Displays the image of the left and right sides of the vehicle.

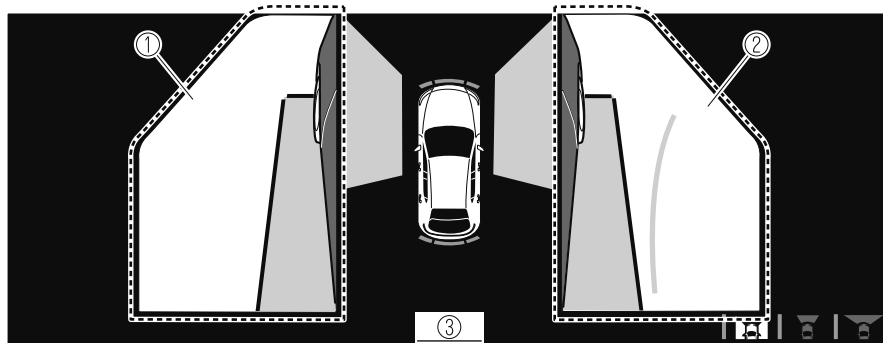

1. Left side view screen
2. Right side view screen
3. "Check surroundings for safety." message is displayed

Top view/Rear view

Displays the image of the area around the vehicle and the rear of the vehicle.

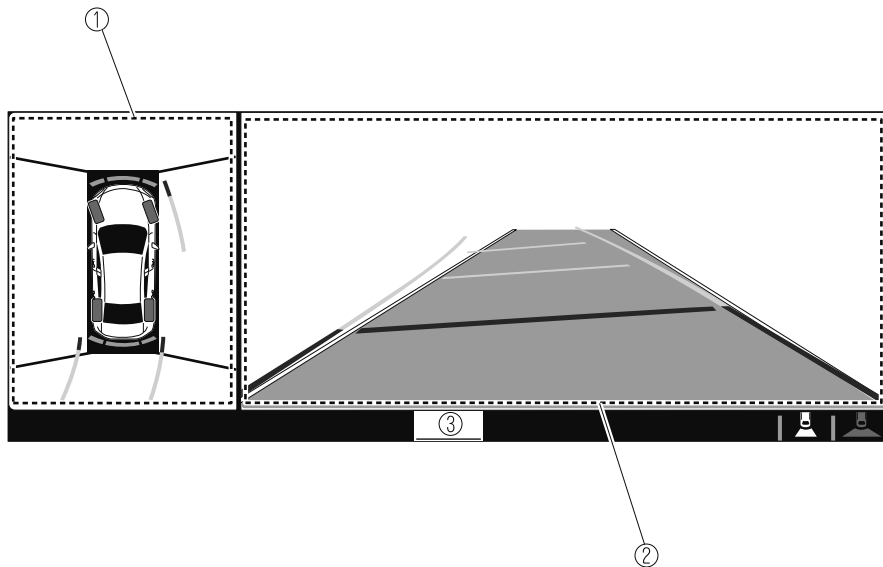

1. Top view screen
2. Rear view screen

When Driving

i-ACTIVSENSE

3. “Check surroundings for safety.” message is displayed

Top view/Rear wide view

Displays the image of the area around the vehicle and the rear of the vehicle (wide-area).

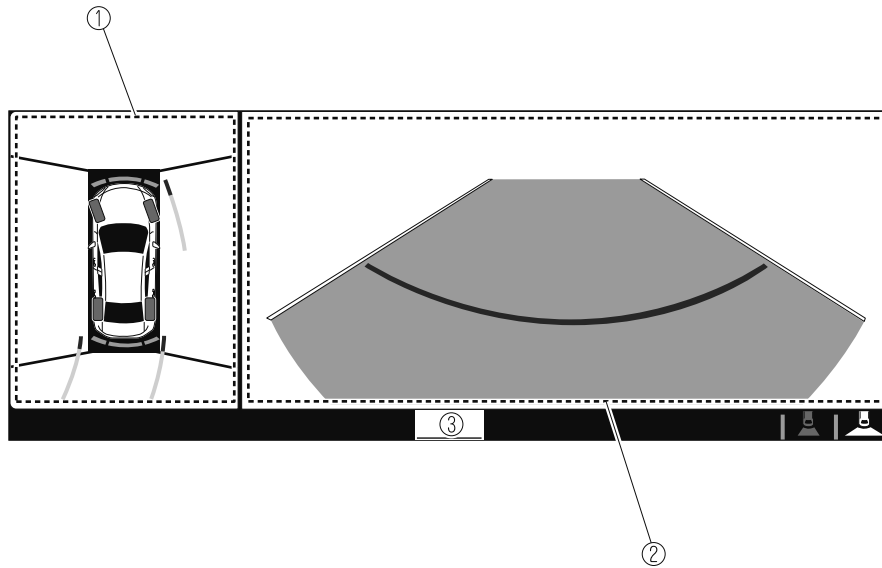

1. Top view screen
2. Rear wide view screen
3. “Check surroundings for safety.” message is displayed

▼ How to Use the System

Top view/Front view, Top view/Front wide view, Side view

Indication

Images are displayed on the screen when the 360°View Monitor switch is pressed with all of the following conditions met.

- The ignition is switched ON.

- The shift lever/selector lever is in a position other than R.

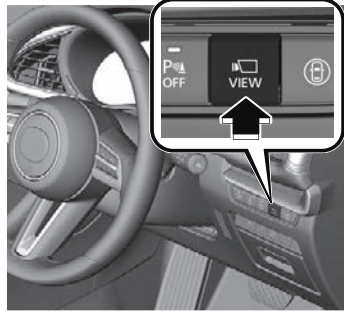

Display switching

The displayed screen can be changed each time the 360°view monitor switch is pressed.

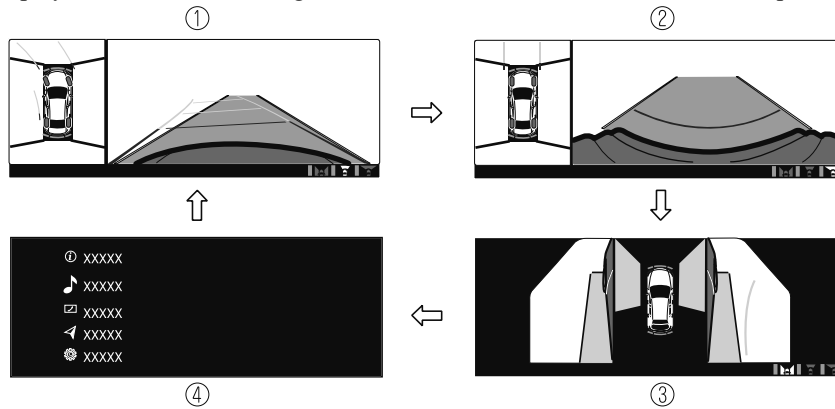

1. Top view/Front view
2. Top view/Front wide view
3. Side view
4. Home screen

NOTE

- When the shift lever/selector lever is in R position, the displayed screen does not switch to the top view/front view, top view/front wide view, or the side view.
- Display of the top view/front view, top view/front wide view, or the side view stops even with the display conditions met if any of the following conditions occurs.
 - When a switch around the commander knob is pressed.
 - **(Manual transmission)**
The parking brake is applied.

i-ACTIVSENSE

· **(Automatic transmission)**

The selector lever is shifted to P position (displayed when the selector lever is in a position other than P).

· **(Displayed when vehicle speed is less than 15 km/h (9.3 mph))**

- 4 minutes and 30 seconds have passed.
- The vehicle speed is about 15 km/h (9.3 mph) or faster.

· **(Displayed when the vehicle speed is about 15 km/h (9.3 mph) or faster)**

- The vehicle speed is about 15 km/h (9.3 mph) or faster after 8 seconds have passed since pressing the 360°View Monitor switch.
- Four minutes and 22 seconds have passed from the point when the vehicle speed was less than 15 km/h (9.3 mph) after 8 seconds have passed since pressing the 360°View Monitor switch.
- The 360°View Monitor settings can be changed as follows.
Refer to the Settings section in the MZD Connect Owner's Manual.
 - Automatic display of the 360°View Monitor when the ultrasonic sensor detects an obstruction.
 - Automatic display of the 360°View Monitor when the ignition is switched ON.
 - Screen priority level when the system launches

Top view/Rear view, Top view/Rear wide view

The top view/rear view, top view/rear wide view displays when all of the following conditions are met.

- The ignition is switched ON.
- Shift lever/selector lever is in R position.

Display switching

The displayed screen can be changed each time the 360°view monitor switch is pressed.

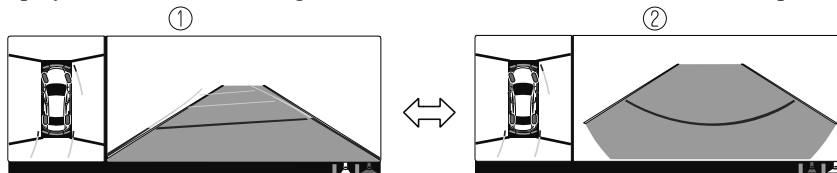

1. Top view/Rear view
2. Top view/Rear wide view

NOTE

- The top view/rear view and top view/rear wide view automatically display whether or not the 360°View Monitor switch is turned on or off when shifting the shift lever/selector lever to R position.

- The top view/rear view and top view/rear wide view displays the previously displayed screen.
- The setting can be changed to display the top view/front view when shifting from reverse to a forward gear without operating the 360°View Monitor switch to check the front of the vehicle while parallel parking.
 Refer to the Settings section in the MZD Connect Owner's Manual.

Screen operation/icon

⚠ WARNING

Always stop the vehicle when adjusting the 360°View Monitor image quality.

Do not adjust the 360°View Monitor image quality while driving. If you adjust the 360°View Monitor image quality (such as brightness, contrast, tone, and colour density) while driving, it could lead to an unexpected accident.

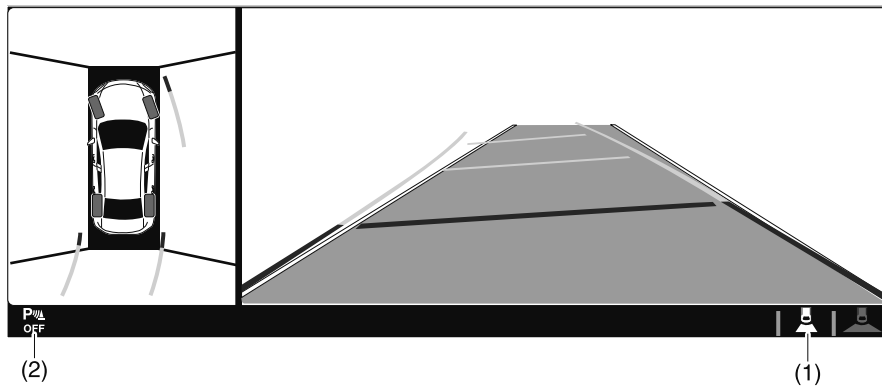

	Display/Icon	Content
(1)	View status icon	Indicates which image is displayed among the front view/front wide view/side view/rear view/rear wide view.
(2)	Parking sensor status icon	Indicates that the parking sensor has a problem or it is switched off.

When Driving

i-ACTIVSENSE

▼ Top View/Front View

Use the top view/front view to assist in checking the safety of the surrounding area when accelerating from a stop, parking, or stopping the vehicle.

Display range

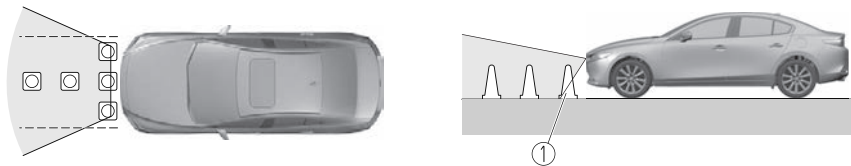
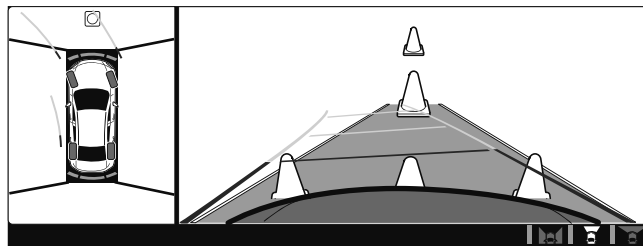

1. Target object

NOTE

- In the top view screen, the areas in black at the front and rear of the vehicle image and the seams where each of the camera images merge are blind spots.
- Because images displayed in the top view screen are processed from each camera, the top view screen may display in the following ways.
 - If an image containing an object with a conspicuous colour is picked up by any of the cameras, the screen area for each camera may be affected and it may display in that colour.
 - Obstructions displayed in the front view may not display on the top view screen.
 - If the position or angle of each camera changes due to tilting of the vehicle, the image may appear distorted.
 - Lines on the road may appear distorted at the seams where each of the camera images merge.
 - The screen area for each camera may appear bright/dark depending on the illumination level around any of the cameras.

Viewing the screen

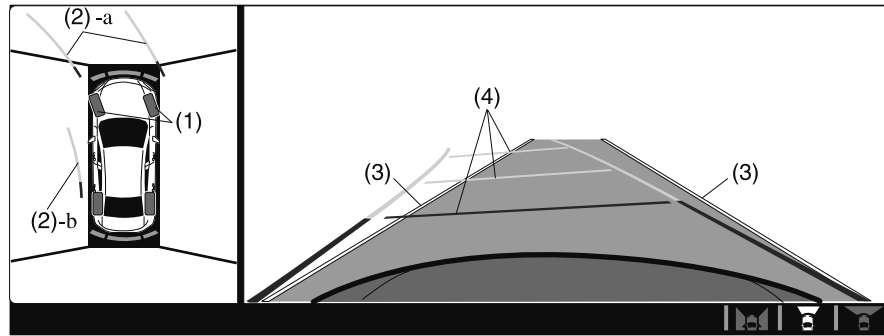

	Display/Icon	Content
(1)	Tyre icon	Indicates the tyre direction. Moves in conjunction with the steering wheel operation.
(2)	Projected vehicle path lines (yellow & red)	Indicates the approximate projected path of the vehicle. Moves in conjunction with the steering wheel operation. a) Indicates the path where the edge of the front bumper is expected to travel. b) Indicates the path where the inner side of the vehicle is expected to travel.
(3)	Extended vehicle width lines (blue)	Indicates the approximate width of the vehicle.
(4)	Projected vehicle path distance guide lines (yellow & red)	Indicates the distance (from front end of bumper) in front of the vehicle. <ul style="list-style-type: none"> • The red line indicates the point about 0.5 m (19 in) from the front end of the bumper. • The yellow lines indicate the points about 1.0 m (39 in) and 2.0 m (78 in) from the front end of the bumper.

CAUTION

The parking sensor detection range has limitations. For example, obstructions closing in from the side and objects short in height may not be detected. Always confirm the safety around the vehicle visually when driving.

For details, refer to the parking sensor obstruction detection indication and warning sound. Refer to Parking Sensor System on page 4-236.

NOTE

The setting can be changed so that the projected vehicle path lines are not displayed. Refer to the Settings section in the MZD Connect Owner's Manual.

When Driving

i-ACTIVSENSE

How to use the projected vehicle path line function

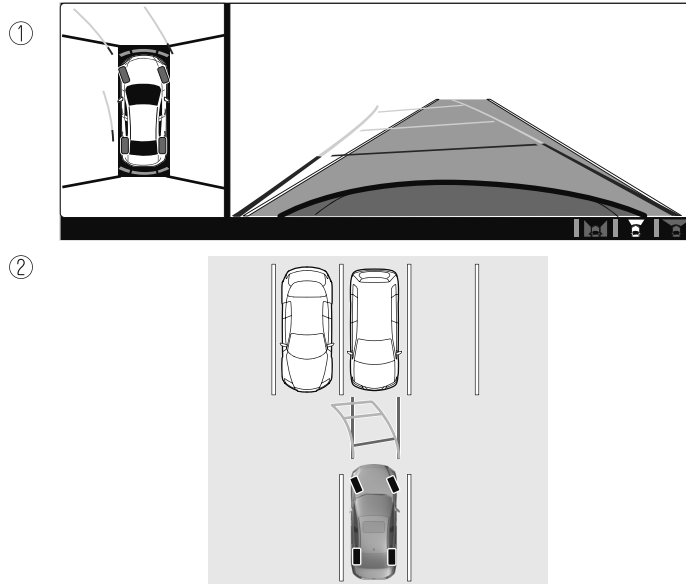

1. (Screen display)
2. (Actual condition)

Make sure that there are no obstructions within the projected vehicle path lines.
Drive the vehicle forward while turning the steering wheel so that no obstructions come within the projected vehicle path lines.

▼ **Top View/Front Wide View**

Use the top view/front wide view to assist in checking the safety of the surrounding area when accelerating from a stop or entering a T-shaped intersection and intersection.

Display range

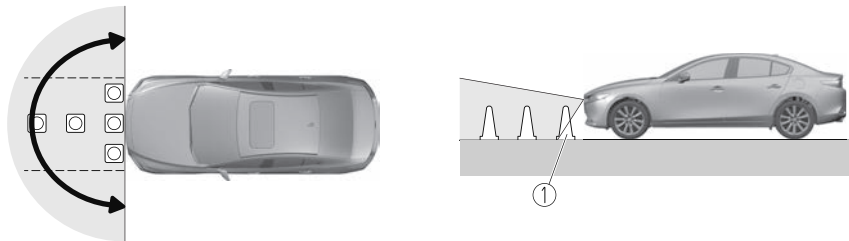
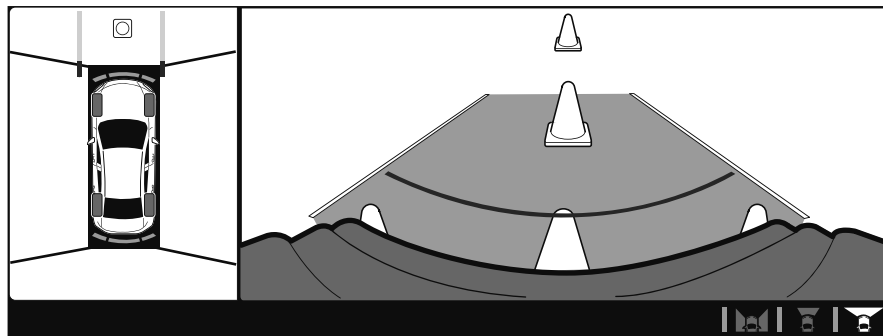

1. Target object

NOTE

- In the top view screen, the areas in black at the front and rear of the vehicle image and the seams where each of the camera images merge are blind spots.
- Because images displayed in the top view screen are processed from each camera, the top view screen may display in the following ways.
 - If an image containing an object with a conspicuous colour is picked up by any of the cameras, the screen area for each camera may be affected and it may display in that colour.
 - Obstructions displayed in the front view may not display on the top view screen.
 - If the position or angle of each camera changes due to tilting of the vehicle, the image may appear distorted.
 - Lines on the road may appear distorted at the seams where each of the camera images merge.

When Driving

i-ACTIVSENSE

- The screen area for each camera may appear bright/dark depending on the illumination level around any of the cameras.

Viewing the screen

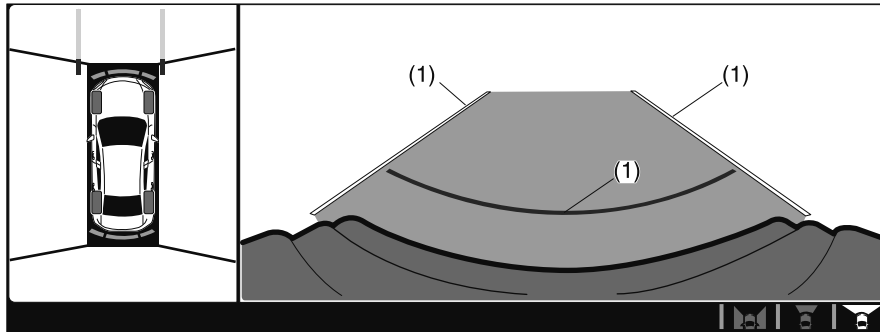

	Display/Icon	Content
(1)	Extended vehicle width lines and distance guide lines (blue & red)	Indicates the approximate width of the vehicle and the distance (from front end of bumper) in front of the vehicle. <ul style="list-style-type: none">• The red lines indicate the points up to about 0.5 m (19 in) from the front end of the bumper.

NOTE

The front wide view screen displays the image in front of the vehicle at a wide angle and corrects the image to help detect approaching obstructions from the side. Therefore, it differs from the actual view.

▼ Side View

Use the side view to assist in checking the safety of the surrounding area when accelerating from a stop, parking, or stopping the vehicle.

Display range

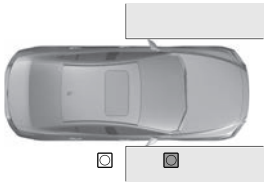
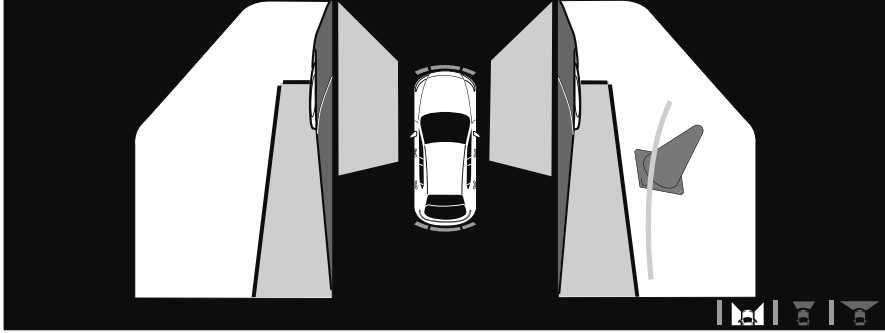

1. Target object

Viewing the screen

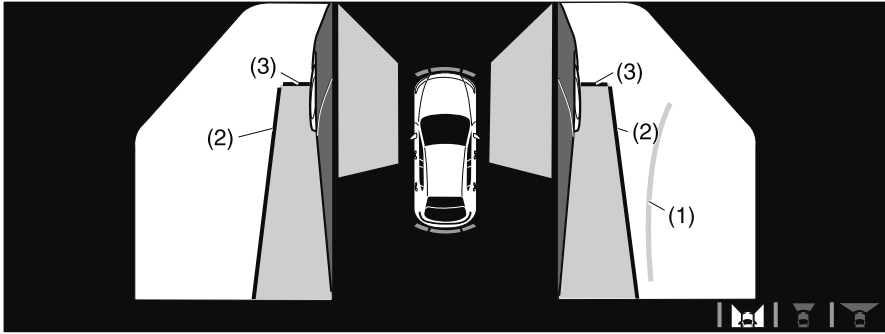

	Display/Icon	Content
(1)	Projected vehicle path lines (yellow)	Indicates the approximate projected path of the vehicle. Moves in conjunction with the steering wheel operation. The projected vehicle path lines (yellow) indicate the path the inner side of the vehicle is expected to travel.
(2)	Vehicle parallel guide lines (blue)	Indicates the approximate vehicle width including the door mirrors.

When Driving

i-ACTIVSENSE

	Display/Icon	Content
(3)	Vehicle front end guide lines (blue)	Indicates the point about 0.25 m (9.84 in) from the front edge of the vehicle (front edge of the bumper).

NOTE

The setting can be changed so that the projected vehicle path lines are not displayed. Refer to the Settings section in the MZD Connect Owner's Manual.

How to use the projected vehicle path line function

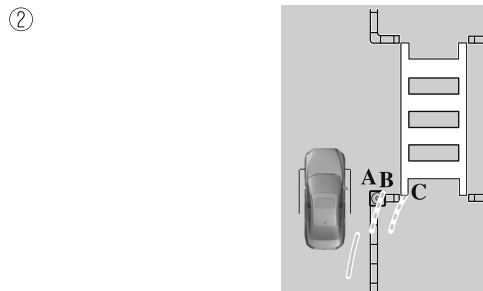
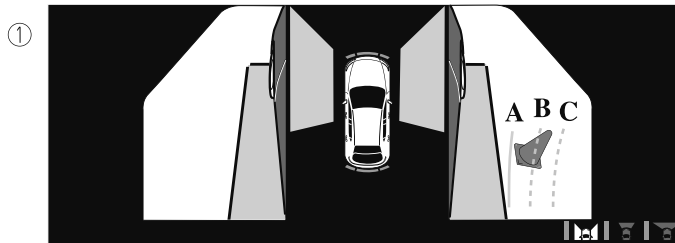

1. (Screen display)
2. (Actual condition)

Make sure that there are no obstructions within the projected vehicle path lines. Turn the steering wheel so that the projected vehicle path lines travel inside of the obstruction (A), and drive the vehicle forward until it passes the obstruction. If the projected vehicle path lines are on an obstruction (B) or outside of the obstruction (C), the vehicle may contact the obstruction when turning the vehicle sharply.



➤ The parking sensor detection range has limitations. For example, obstructions closing in from the side and objects short in height may not be detected. Always confirm the safety around the vehicle visually when driving.

4-192

For details, refer to the parking sensor obstruction detection indication and warning sound. Refer to Parking Sensor System on page 4-236.

- Do not turn the steering wheel any more until the vehicle has passed the obstruction, even if the obstruction is not visible on the side view image. If the steering wheel is turned even more, the vehicle may contact the obstruction if it is turned sharply.

NOTE

- Because there might be a difference between the image displayed on the screen and the actual conditions, always check the safety of the surrounding area using the mirrors and directly with your eyes when driving.
- Even though the object displayed on the screen, such as a road curb or a division line of a parking space, and the vehicle parallel guide lines appear parallel, they may not actually be parallel.

▼ Top View/Rear View

Use the top view/rear view to assist in checking the safety of the surrounding area when accelerating from a stop, parking, or stopping the vehicle.

Range of displayed screen image

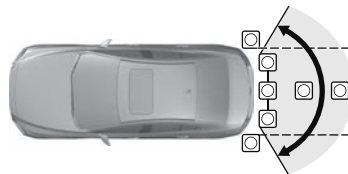
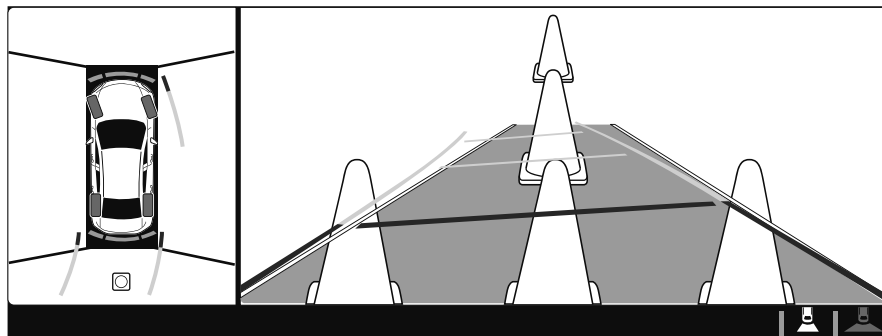

1. Target object

NOTE

- In the top view screen, the areas in black at the front and rear of the vehicle image and the seams where each of the camera images merge are blind spots.

When Driving

i-ACTIVSENSE

- Because images displayed in the top view screen are processed from each camera, the top view screen may display in the following ways.
- If an image containing an object with a conspicuous colour is picked up by any of the cameras, the screen area for each camera may be affected and it may display in that colour.
- Obstructions displayed in the rear view may not display on the top view screen.
- If the position or angle of each camera changes due to tilting of the vehicle, the image may appear distorted.
- Lines on the road may appear distorted at the seams where each of the camera images merge.
- The screen area for each camera may appear bright/dark depending on the illumination level around any of the cameras.

Viewing the screen

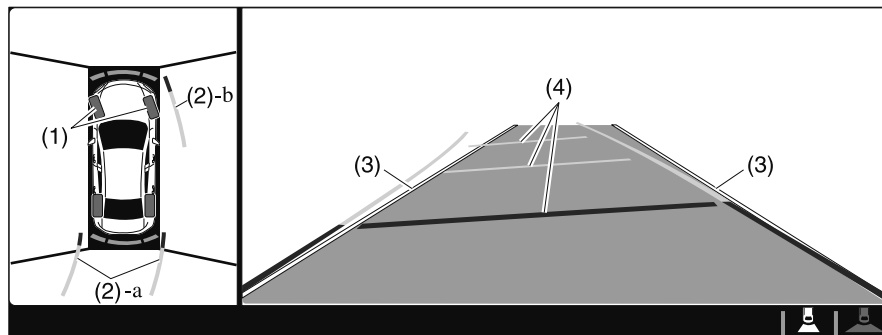

	Display/Icon	Content
(1)	Tyre icon	Indicates the tyre direction. Moves in conjunction with the steering wheel operation.
(2)	Projected vehicle path lines (yellow & red)	Indicates the approximate projected path of the vehicle. Moves in conjunction with the steering wheel operation. a) Indicates the path where the edge of the rear bumper is expected to travel. b) Indicates the path where the outer side of the vehicle is expected to travel.
(3)	Extended vehicle width lines (blue)	These guide lines indicate the approximate width of the vehicle.

4-194

	Display/Icon	Content
(4)	Projected vehicle path distance guide lines (yellow & red)	<p>These guide lines indicate the approximate distance to a point measured from the rear of the vehicle (from the end of the bumper).</p> <ul style="list-style-type: none"> • The red line indicates the point about 0.5 m (19 in) from the rear end of the bumper. • The yellow lines indicate the points about 1.0 m (39 in) and 2.0 m (78 in) from the rear end of the bumper.

NOTE

The setting can be changed so that the projected vehicle path lines are not displayed. Refer to the Settings section in the MZD Connect Owner's Manual.

How to use the projected vehicle path line function



- *The front of the vehicle swings out wide when turning the steering wheel while reversing. Maintain sufficient distance between the vehicle and an obstruction.*
- *The parking sensor detection range has limitations. For example, obstructions closing in from the side and objects short in height may not be detected. Always confirm the safety around the vehicle visually when driving. For details, refer to the parking sensor obstruction detection indication and warning sound. Refer to Parking Sensor System on page 4-236.*

NOTE

- *Because there might be a difference between the image displayed on the screen, such as indicated in the following, and the actual conditions when parking, always check the safety at the rear of the vehicle and the surrounding area directly with your eyes.*
 - *Even though the back end of the parking space (or garage) displayed on the screen and distance guide lines appear parallel, they may not actually be parallel.*
 - *When parking in a space with a division line on only one side of the parking space, even though the division line and the vehicle width guide line appear parallel, they may not actually be parallel.*
- *The following shows an example of vehicle parking with the steering wheel turned to the left while backing up the vehicle. When backing into a parking space from the opposite direction, the steering operation is reversed.*

When Driving

i-ACTIVSENSE

1. Back the vehicle into the parking space by turning the steering wheel so that the vehicle enters the centre of the parking space.

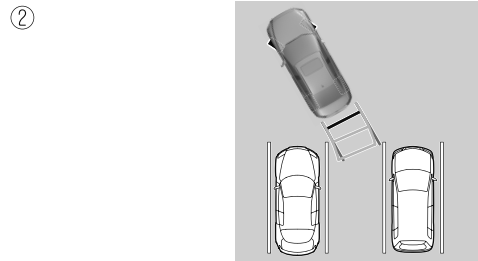
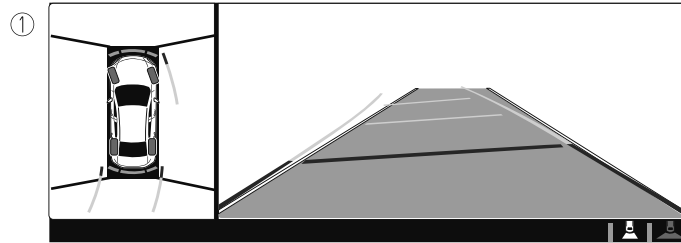

1. (Screen display)
 2. (Actual condition)
2. After the vehicle starts entering the parking space, stop and adjust the steering wheel so that the distance between the vehicle width lines and the sides of the parking space on the left and right are roughly equal, and then continue backing up slowly.

3. Once the vehicle width lines and the sides of the parking space on the left and right are parallel, straighten the wheels and back the vehicle slowly into the parking space. Continue checking the vehicle's surroundings and then stop the vehicle in the best possible position. (If the parking space has division lines, check whether the vehicle width guide lines are parallel to them.)

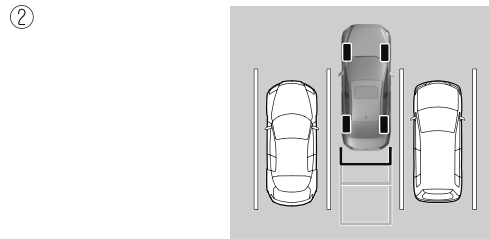
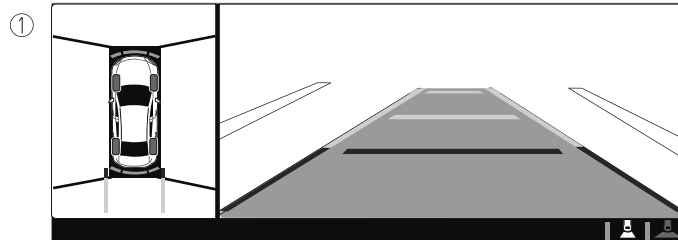

1. (Screen display)
2. (Actual condition)

When Driving

i-ACTIVSENSE

▼ Top View/Rear Wide View

Use the top view/rear wide view to assist in checking the safety of the surrounding area when accelerating from a stop, parking, or stopping the vehicle.

Range of displayed screen image

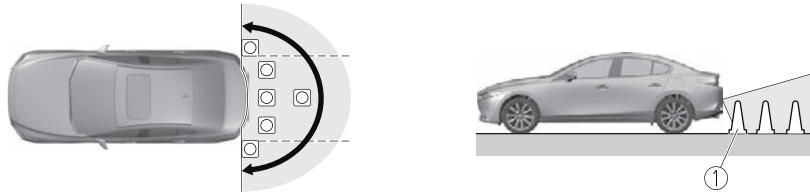
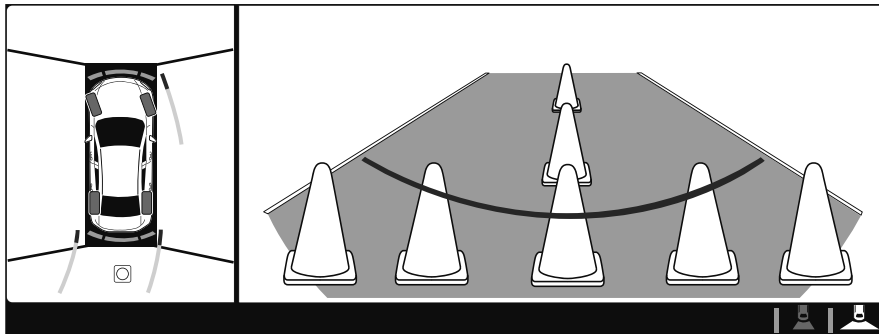

1. Target object

NOTE

- In the top view screen, the areas in black at the front and rear of the vehicle image and the seams where each of the camera images merge are blind spots.
- Because images displayed in the top view screen are processed from each camera, the top view screen may display in the following ways.
 - If an image containing an object with a conspicuous colour is picked up by any of the cameras, the screen area for each camera may be affected and it may display in that colour.
 - Obstructions displayed in the front view may not display on the top view screen.
 - If the position or angle of each camera changes due to tilting of the vehicle, the image may appear distorted.
 - Lines on the road may appear distorted at the seams where each of the camera images merge.
 - The screen area for each camera may appear bright/dark depending on the illumination level around any of the cameras.

4-198

Viewing the screen

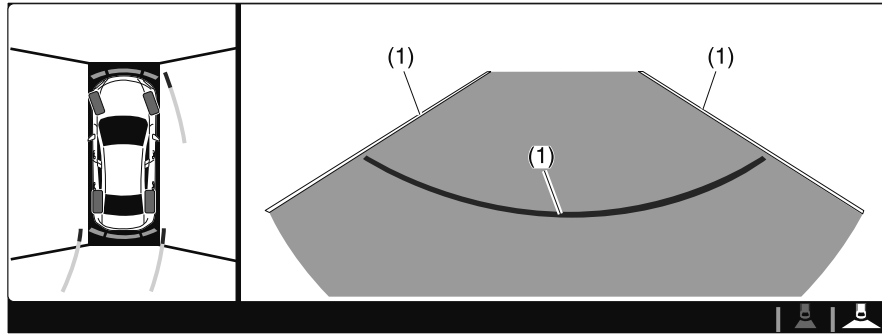

	Display/Icon	Content
(1)	Extended vehicle width lines and distance guide lines (blue & red)	<p>These guide lines indicate the approximate width of the vehicle and distance to a point measured from the rear of the vehicle (from the end of the bumper).</p> <ul style="list-style-type: none"> • The red lines indicate the points up to about 0.5 m (19 in) from the rear end of the bumper.

NOTE

The top view/rear wide view screen displays the image at the rear of the vehicle at a wide angle and corrects the image to help detect approaching obstructions from the side. Therefore, it differs from the actual view.

▼ Margin of Error Between Road Surface on Screen and Actual Road Surface

There might be some margin of error between the road surface appearing on the screen and the actual road surface. A margin of error in the perceived distance could lead to an accident, therefore be aware of the following conditions which can more easily produce errors in the perceived distance.

The vehicle tilts due to weight of passengers and cargo.

If the vehicle is tilted, obstructions picked up by a camera can appear farther or closer than the actual distance from the vehicle.

When Driving

i-ACTIVSENSE

Front camera

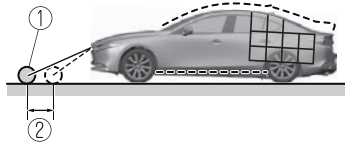

1. Obstruction
2. Margin of error

Side camera

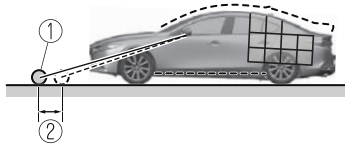

1. Obstruction
2. Margin of error

Rear camera

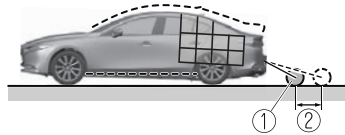

1. Obstruction
2. Margin of error

There is a steep up or down grade in the road at the front or rear of the vehicle

If there is a steep up or down grade in the road at the front or rear of the vehicle, obstructions picked up by the camera can appear farther or closer than the actual distance from the vehicle.

Front camera

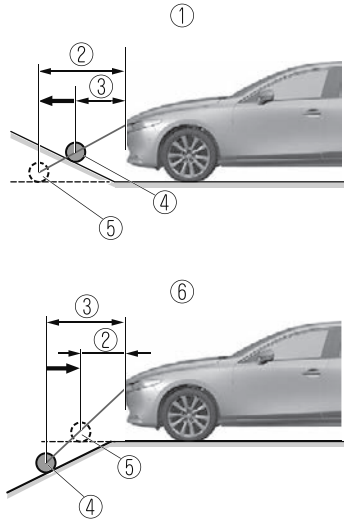

1. Appears further than actual distance
2. Distance of obstruction being viewed on screen
3. Actual distance of obstruction from vehicle
4. Actual obstruction
5. Obstruction appearing on screen
6. Appears closer than actual distance

When Driving
i-ACTIVSENSE

Side camera

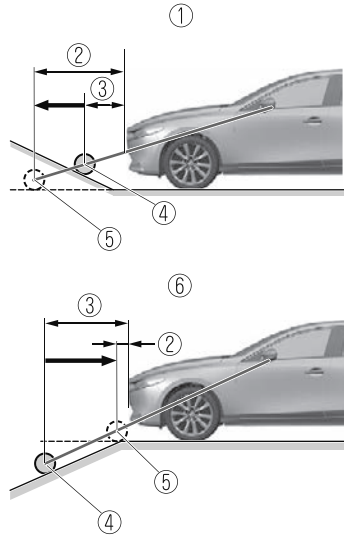

1. Appears further than actual distance
2. Distance of obstruction being viewed on screen
3. Actual distance of obstruction from vehicle
4. Actual obstruction
5. Obstruction appearing on screen
6. Appears closer than actual distance

Rear camera

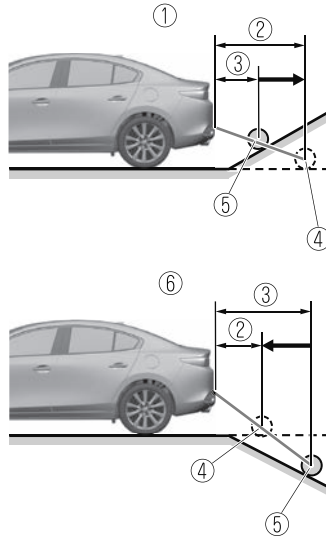

1. Appears further than actual distance
2. Distance of obstruction being viewed on screen
3. Actual distance of obstruction from vehicle
4. Obstruction appearing on screen
5. Actual obstruction
6. Appears closer than actual distance

NOTE

If the vehicle is on a slope, obstructions taken by the camera can appear farther or closer than the actual distance from the vehicle.

Three-dimensional object at vehicle front or rear

Because the vehicle front end guide lines (side camera) or the distance guide lines (rear camera) are displayed based on a flat surface, the distance to the three-dimensional object displayed on the screen is different from the actual distance.

When Driving
i-ACTIVSENSE

Side camera

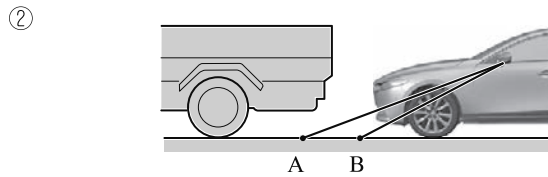
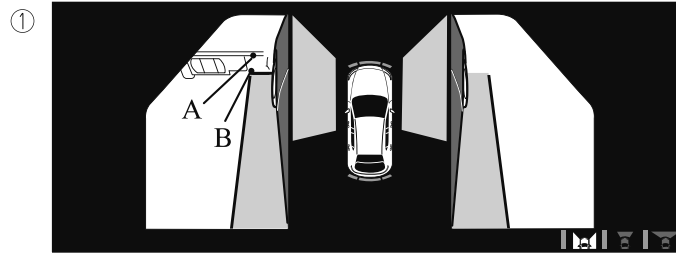

1. (Screen display)
2. (Actual condition)

Rear camera

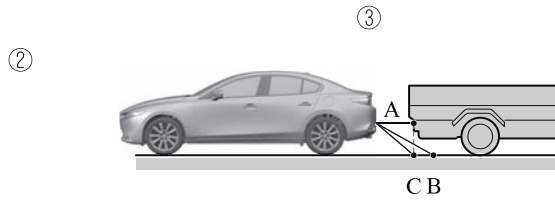
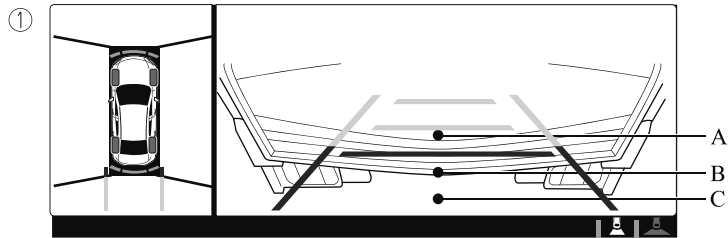

1. (Screen display)
2. (Actual condition)
3. Sensed distance on screen $A > B > C$
4. Actual distance $B > C = A$

4-204

▼ **System Problem Indication**

Centre display indication	Cause	Action to be taken
“No camera signal.” is displayed	The control unit might be damaged.	Have your vehicle inspected by an Authorised Mazda Repairer.
Screen is pitch-black and blank	The camera might be damaged.	

Forward Sensing Camera (FSC)

▼ Forward Sensing Camera (FSC)

Your vehicle is equipped with a Forward Sensing Camera (FSC). The Forward Sensing Camera (FSC) is positioned near the rearview mirror and used by the following systems.

- High Beam Control System (HBC)
- Adaptive LED Headlights (ALH)
- Traffic Sign Recognition System (TSR)
- Distance & Speed Alert (DSA)
- Driver Attention Alert (DAA)
- Driver Monitoring (DM)
- Mazda Radar Cruise Control (MRCC)
- Mazda Radar Cruise Control with Stop & Go function (MRCC with Stop & Go function)
- Lane-keep Assist System (LAS)
- Cruising & Traffic Support (CTS)
- Smart Brake Support (SBS)

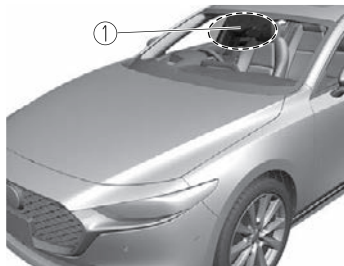

1. Forward Sensing Camera (FSC)

The Forward Sensing Camera (FSC) determines the conditions ahead of the vehicle while travelling at night and detects traffic lanes. The distance in which the Forward Sensing Camera (FSC) can detect objects varies depending on the surrounding conditions.

4-206

⚠ WARNING

Do not modify the suspension:

If the vehicle height or inclination is changed, the system will not be able to correctly detect vehicles ahead. This will result in the system not operating normally or mistakenly operating, which could cause a serious accident.

⚠ CAUTION

- *Do not apply accessories, stickers or film to the windscreen near the Forward Sensing Camera (FSC).
If the area in front of the Forward Sensing Camera (FSC) lens is obstructed, it will cause the system to not operate correctly. Consequently, each system may not operate normally which could lead to an unexpected accident.*
- *Do not disassemble or modify the Forward Sensing Camera (FSC).
Disassembly or modification of the Forward Sensing Camera (FSC) will cause a malfunction or mistaken operation. Consequently, each system may not operate normally which could lead to an unexpected accident.*
- *Heed the following cautions to assure the correct operation of the Forward Sensing Camera (FSC).*
 - *Be careful not to scratch the Forward Sensing Camera (FSC) lens or allow it to get dirty.*
 - *Do not remove the Forward Sensing Camera (FSC) cover.*
 - *Do not place objects on the instrument panel which reflect light.*

- *Always keep the windscreen glass around the camera clean by removing dirt or fogging. Use the windscreen defroster to remove fogging on the windscreen.*
 - *Consult an expert repairer, we recommend an Authorised Mazda Repairer regarding cleaning the interior side of the windscreen around the Forward Sensing Camera (FSC).*
 - *Consult an expert repairer, we recommend an Authorised Mazda Repairer before performing repairs around the Forward Sensing Camera (FSC).*
 - *The Forward Sensing Camera (FSC) is installed to the windscreen. Consult an expert repairer, we recommend an Authorised Mazda Repairer for windscreen repair and replacement.*
 - *When cleaning the windscreen, do not allow glass cleaners or similar cleaning fluids to get on the Forward Sensing Camera (FSC) lens. In addition, do not touch the Forward Sensing Camera (FSC) lens.*
 - *When performing repairs around the rearview mirror, consult an expert repairer, we recommend an Authorised Mazda Repairer.*
 - *Consult an expert repairer, we recommend an Authorised Mazda Repairer regarding cleaning of the camera lens.*
- *Do not hit or apply strong force to the Forward Sensing Camera (FSC) or the area around it. If the Forward Sensing Camera (FSC) is severely hit or if there are cracks or damage caused by flying gravel or debris in the area around it, stop using the following systems and consult an expert repairer, we recommend an Authorised Mazda Repairer.*
 - *High Beam Control System (HBC)*
 - *Adaptive LED Headlights (ALH)*
 - *Lane Departure Warning System (LDWS)*
 - *Traffic Sign Recognition System (TSR)*
 - *Distance & Speed Alert (DSA)*
 - *Driver Attention Alert (DAA)*
 - *Driver Monitoring (DM)*
 - *Mazda Radar Cruise Control (MRCC)*
 - *Mazda Radar Cruise Control with Stop & Go function (MRCC with Stop & Go function)*
 - *Lane-keep Assist System (LAS)*
 - *Cruising & Traffic Support (CTS)*
 - *Smart Brake Support (SBS)*
 - *The direction in which the Forward Sensing Camera (FSC) is pointed has been finely adjusted. Do not change the installation position of the Forward Sensing Camera (FSC) or remove it. Otherwise, it could result in damage or malfunction.*
 - *Always use tyres for all wheels that are of the specified size, and the same manufacturer, brand, and tread pattern. In addition, do not use tyres with significantly different wear patterns on the same vehicle as the system may not operate normally.*

➤ *The Forward Sensing Camera (FSC) includes a function for detecting a soiled windscreen and informing the driver, however, depending on the conditions, it may not detect plastic shopping bags, ice or snow on the windscreen. In such cases, the system cannot accurately determine a vehicle ahead and may not be able to operate normally. Always drive carefully and pay attention to the road ahead.*

NOTE

- *In the following cases, the Forward Sensing Camera (FSC) cannot detect target objects correctly, and each system may be unable to operate normally.*
 - *The height of the vehicle ahead is low.*
 - *You drive your vehicle at the same speed as the vehicle ahead.*
 - *Headlights are not turned on during the night or when going through a tunnel.*
- *In the following cases, the Forward Sensing Camera (FSC) may not be able to detect target objects correctly.*
 - *Under bad weather condition, such as rain, fog and snow.*
 - *The window washer is being used or the windscreen wipers are not used when it's raining.*
 - *Ice, fog, snow, frost, rainfall, dirt, or foreign matter such as a plastic bag is stuck on the windscreen.*
 - *Trucks with low loading platforms and vehicles with an extremely low or high profile.*
 - *When driving next to walls with no patterning (including fences and longitudinally striped walls).*

- *The tail lights of the vehicle ahead are turned off.*
- *A vehicle is outside the illumination range of the headlights.*
- *The vehicle is making a sharp turn, or ascending or descending a steep slope.*
- *Entering or exiting a tunnel.*
- *Heavy luggage is loaded causing the vehicle to tilt.*
- *Strong light is shone at the front of the vehicle (back light or high-beam light from on-coming vehicles).*
- *There are many light emitters on the vehicle ahead.*
- *When the vehicle ahead is not equipped with tail lights or the tail lights are turned off at nighttime.*
- *Elongated luggage or cargo is loaded onto installed roof rails and covers the Forward Sensing Camera (FSC).*
- *Exhaust gas from the vehicle in front, sand, snow, and water vapour rising from manholes and grating, and water splashed into the air.*
- *When towing a malfunctioning vehicle.*
- *The vehicle is driven with tyres having significantly different wear.*
- *The vehicle is driven on down slopes or bumpy roads.*
- *There are water puddles on the road.*
- *The surroundings are dark such as during the night, early evening, or early morning, or in a tunnel or indoor parking lot.*
- *The illumination brightness of the headlights is reduced or the headlight illumination is weakened due to dirt or a deviated optical axis.*

- *The target object enters the blind spot of the Forward Sensing Camera (FSC).*
- *A person or object bursts onto the road from the shoulder or cuts right in front of you.*
- *You change lanes and approach a vehicle ahead.*
- *When driving extremely close to the target object.*
- *Tyre chains or a temporary spare tyre is installed.*
- *The vehicle ahead has a special shape. For example, a vehicle towing a trailer house or a boat, or a vehicle carrier carrying a vehicle with its front pointed rearward.*
- *If the Forward Sensing Camera (FSC) cannot operate normally due to rain, backlight, or fog, the system functions related to the Forward Sensing Camera (FSC) are temporarily stopped and the following warning lights turn on. However, this does not indicate a malfunction.*
 - *High Beam Control System (HBC) warning indication/warning light (amber)*
 - *Adaptive LED Headlights (ALH) warning indication/warning light (amber)*
 - *i-ACTIVSENSE warning indication/warning light*
- *If the Forward Sensing Camera (FSC) cannot operate normally due to high temperatures, the system functions related to the Forward Sensing Camera (FSC) are temporarily stopped and the following warning lights turn on. However, this does not indicate a malfunction. Cool down the area around the Forward Sensing Camera (FSC) such as by turning on the air conditioner.*
 - *High Beam Control System (HBC) warning indication/warning light (amber)*
 - *Adaptive LED Headlights (ALH) warning indication/warning light (amber)*
 - *i-ACTIVSENSE warning indication/warning light*
- *If the Forward Sensing Camera (FSC) detects that the windscreen is dirty or foggy, the system functions related to the Forward Sensing Camera (FSC) are temporarily stopped and the following warning lights turn on. However, this does not indicate a problem. Remove the dirt from the windscreen or press the defroster switch and defog the windscreen.*
 - *High Beam Control System (HBC) warning indication/warning light (amber)*
 - *Adaptive LED Headlights (ALH) warning indication/warning light (amber)*
 - *i-ACTIVSENSE warning indication/warning light*

- If there are recognizable cracks or damage caused by flying gravel or debris on the windscreen, always have the windscreen replaced. Consult an Authorised Mazda Repairer for replacement.
- The Forward Sensing Camera (FSC) recognises pedestrians when all of the following conditions are met:
 - The height of a pedestrian is about 1 to 2 meters.
 - An outline such as the head, both shoulders, or the legs can be determined.
- In the following cases, the Forward Sensing Camera (FSC) may not be able to detect target objects correctly:
 - Multiple pedestrians are walking, or there are groups of people.
 - A pedestrian is close to a separate object.
 - A pedestrian is crouching, lying, or slouching.
 - A pedestrian suddenly jumps into the road right in front of the vehicle.
 - A pedestrian opens an umbrella, or is carrying large baggage or articles.
 - A pedestrian is in a dark location such as during the night, or blends into the background by wearing clothes matching the background colour.

Front Radar Sensor

▼ Front Radar Sensor

Your vehicle is equipped with a front radar sensor.

The following systems also use the front radar sensor.

- Distance & Speed Alert (DSA)
- Mazda Radar Cruise Control (MRCC)
- Mazda Radar Cruise Control with Stop & Go function (MRCC with Stop & Go function)
- Cruising & Traffic Support (CTS)
- Smart Brake Support (SBS)

The front radar sensor functions by detecting the radio waves reflected off a vehicle ahead or an obstruction sent from the radar sensor.

The front radar sensor is mounted behind the front emblem.

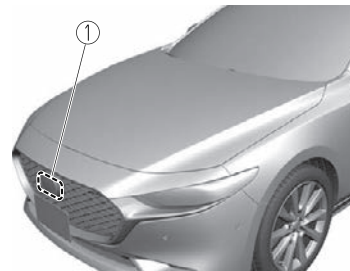

1. Front radar sensor

If “Safety and Driver Support Systems Temporarily Disabled. Front Radar Obscured. Drive Safely” is displayed on the multi-information display of the instrument cluster, clean the area around the front radar sensor.

CAUTION

Heed the following precautions to assure correct operation of each system.

- Do not adhere stickers (including transparent stickers) to the surface of the radiator grille and front emblem in and around the front radar sensor, and do not replace the radiator grille and front emblem with any product that is not a genuine product designed for use with the front radar sensor.
- The front radar sensor includes a function for detecting soiling of the radar sensor's front surface and informing the driver, however, depending on the conditions, it may require time to detect or it may not detect plastic shopping bags, ice or snow. If this occurs, the system may not operate correctly, therefore always keep the front radar sensor clean.
- Do not install a grille guard.
- If the front part of the vehicle has been damaged in a vehicle accident, the position of the front radar sensor may have moved. Stop the system immediately and always have the vehicle inspected at an expert repairer, we recommend an Authorised Mazda Repairer.
- Do not use the front bumper to push other vehicles or obstructions such as when pulling out of a parking space. Otherwise, the front radar sensor could be hit and its position deviated.
- Do not remove, disassemble, or modify the front radar sensor.

- For repairs, replacement or paint work around the front radar sensor, consult an expert repairer, we recommend an Authorised Mazda Repairer.
- Do not modify the suspension. If the suspension are modified, the vehicle's posture could change and the front radar sensor may not be able to correctly detect a vehicle ahead or an obstruction.

NOTE

- Under the following conditions, the front radar sensor may not be able to detect vehicles ahead or obstructions correctly and each system may not operate normally.
 - The rear surface of a vehicle ahead does not reflect radio waves effectively, such as an unloaded trailer or an automobile with a loading platform covered by a soft top, vehicles with a hard plastic tailgate, and round-shaped vehicles.
 - Vehicles ahead with low vehicle height and thus less area for reflecting radio waves.
 - Visibility is reduced due to a vehicle ahead casting off water, snow, or sand from its tyres and onto your windscreen.
 - The boot/luggage compartment is loaded with heavy objects or the rear passenger seats are occupied.
 - Ice, snow, or soiling is on the front surface of the front emblem.
 - During inclement weather such as rain, snow, or sand storms.
 - When driving near facilities or objects emitting strong radio waves.

i-ACTIVSENSE

- *Under the following conditions, the front radar sensor may not be able to detect vehicles ahead or obstructions.*
 - *The beginning and end of a curve.*
 - *Roads with continuous curves.*
 - *Narrow lane roads due to road construction or lane closures.*
 - *The vehicle ahead enters the radar sensor's blind spot.*
 - *The vehicle ahead is running abnormally due to accident or vehicle damage.*
 - *Roads with repeated up and down slopes*
 - *Driving on poor roads or unpaved roads.*
 - *The distance between your vehicle and the vehicle ahead is extremely short.*
 - *A vehicle suddenly comes close such as by cutting into the lane.*
- *To prevent incorrect operation of the system, use tyres of the same specified size, manufacturer, brand, and tread pattern on all four wheels. In addition, do not use tyres with significantly different wear patterns or tyre pressures on the same vehicle (Including the temporary spare tyre).*
- *If the battery power is weak, the system may not operate correctly.*
- *When driving on roads with little traffic and few vehicles ahead or obstructions for the front radar sensor to detect, "Safety and Driver Support Systems Temporarily Disabled. Front Radar Obscured. Drive Safely" may be temporarily displayed, however, this does not indicate a problem.*
- *The radar sensors are regulated by the relevant radio wave laws of the country in which the vehicle is driven. If the vehicle is driven abroad, authorization from the country in which the vehicle is driven may be required.*

4-212

Front Side Radar Sensor*

▼ Front Side Radar Sensor

Your vehicle is equipped with front side radar sensor. The following systems also use the front side radar sensor.

- Front Cross Traffic Alert (FCTA)

The front side radar sensor function by detecting the radio waves reflected off a vehicle approaching from the front or an obstruction sent from the radar sensor.



1. Front side radar sensor

The front side radar sensor are installed inside the front bumper, one each on the left and right sides.

Always keep the surface of the front bumper near the front side radar sensor clean so that the front side radar sensor operate normally. Also, do not apply items such as stickers.

Refer to Exterior Care on page 6-43.

⚠ CAUTION

If the front bumper receives a severe impact, the system may no longer operate normally. Stop the system immediately and have the vehicle inspected at an expert repairer, we recommend an Authorised Mazda Repairer.

NOTE

- *The detection ability of the front side radar sensor has limitations. In the following cases, the detection ability may lower and the system may not operate normally.*
 - *The front bumper near the front side radar sensor has become deformed.*
 - *Snow, ice or mud adheres to the front side radar sensor on the front bumper.*
 - *Under bad weather conditions such as rain, snow and fog.*
- *Under the following conditions, the front side radar sensor cannot detect target objects or it may be difficult to detect them.*
 - *Stationary objects on a road or a road side such as small, pedestrians, animals, and shopping carts.*
 - *Vehicle shapes which do not reflect radar waves well such as empty trailers with a low vehicle height and sports cars.*
- *Vehicles are shipped with the direction of the front side radar sensor adjusted for each vehicle to a loaded vehicle condition so that the front side radar sensor detect approaching vehicles correctly. If the direction of the front side radar sensor has deviated for some reason, have the vehicle inspected at an expert repairer, we recommend an Authorised Mazda Repairer.*
- *For repairs or replacement of the front side radar sensor, or bumper repairs, paintwork, and replacement near the radar sensors, consult an expert repairer, we recommend an Authorised Mazda Repairer.*

*Some models. **4-213**

- The radar sensors are regulated by the relevant radio wave laws of the country in which the vehicle is driven. If the vehicle is driven abroad, authorization from the country in which the vehicle is driven may be required.

Rear Side Radar Sensor

▼ Rear Side Radar Sensor

Your vehicle is equipped with rear side radar sensor. The following systems also use the rear side radar sensor.

- Blind Spot Monitoring (BSM)
- Rear Cross Traffic Alert (RCTA)
- Smart Brake Support [Rear Crossing] (SBS-RC)

The rear side radar sensor function by detecting the radio waves reflected off a vehicle approaching from the rear or an obstruction sent from the radar sensor.

Saloon



1. Rear side radar sensor

Hatchback



1. Rear side radar sensor

The rear side radar sensor are installed inside the rear bumper, one each on the left and right sides.

Always keep the surface of the rear bumper near the rear side radar sensor clean so that the rear side radar sensor operate normally. Also, do not apply items such as stickers.

Refer to Exterior Care on page 6-43.

 **CAUTION**

If the rear bumper receives a severe impact, the system may no longer operate normally. Stop the system immediately and have the vehicle inspected at an expert repairer, we recommend an Authorised Mazda Repairer.

NOTE

- The detection ability of the rear side radar sensor has limitations. In the following cases, the detection ability may lower and the system may not operate normally.*
 - The rear bumper near the rear side radar sensor has become deformed.*
 - Snow, ice or mud adheres to the rear side radar sensor on the rear bumper.*
 - Under bad weather conditions such as rain, snow and fog.*
- Under the following conditions, the rear side radar sensor cannot detect target objects or it may be difficult to detect them.*
 - Stationary objects on a road or a road side such as small, pedestrians, animals, and shopping carts.*
 - Vehicle shapes which do not reflect radar waves well such as empty trailers with a low vehicle height and sports cars.*

- Vehicles are shipped with the direction of the rear side radar sensor adjusted for each vehicle to a loaded vehicle condition so that the rear side radar sensor detect approaching vehicles correctly. If the direction of the rear side radar sensor has deviated for some reason, have the vehicle inspected at an expert repairer, we recommend an Authorised Mazda Repairer.*
- For repairs or replacement of the rear side radar sensor, or bumper repairs, paintwork, and replacement near the radar sensors, consult an expert repairer, we recommend an Authorised Mazda Repairer.*
- The radar sensors are regulated by the relevant radio wave laws of the country in which the vehicle is driven. If the vehicle is driven abroad, authorization from the country in which the vehicle is driven may be required.*

Rear/Rear corner/Rear Side Ultrasonic Sensor*

▼ Rear/Rear corner/Rear Side Ultrasonic Sensor

The ultrasonic sensors function by emitting ultrasonic waves which are reflected off obstructions at the rear and the returning ultrasonic waves are picked up by the ultrasonic sensors.

Saloon

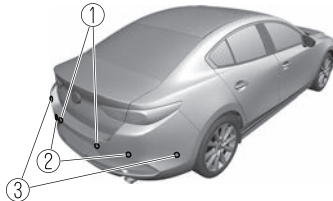

1. Rear ultrasonic sensor
2. Rear corner ultrasonic sensor
3. Rear side ultrasonic sensor

Hatchback

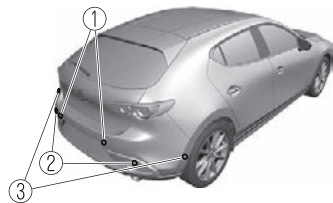

1. Rear ultrasonic sensor
2. Rear corner ultrasonic sensor
3. Rear side ultrasonic sensor

The ultrasonic sensors are mounted in the rear bumper.

Front Camera/Side Cameras/Rear Camera*

▼ Front Camera/Side Cameras/Rear Camera

Your vehicle is equipped with a front camera, side cameras, and a rear camera. The 360°View Monitor uses each camera. Refer to 360°View Monitor on page 4-175.

The front camera, side cameras, and rear camera shoot images of the area surrounding the vehicle.

Each camera is installed to the following positions.

Saloon

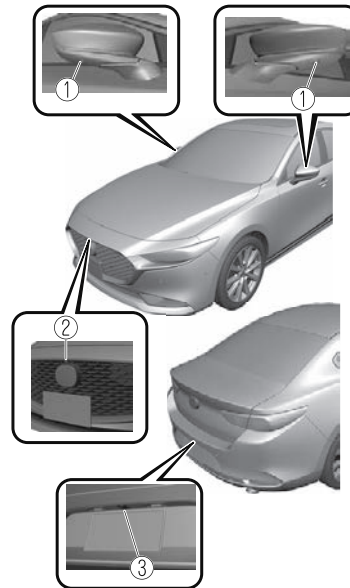

1. Side cameras
2. Front camera
3. Rear camera

Hatchback

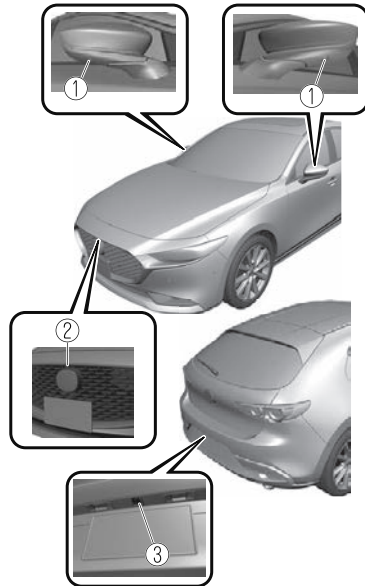

1. Side cameras
2. Front camera
3. Rear camera

Driver Monitoring Camera*

▼ Driver Monitoring Camera

The driver monitoring camera detects changes in the driver's facial features and estimates the amount of accumulated fatigue and sleepiness of the driver.

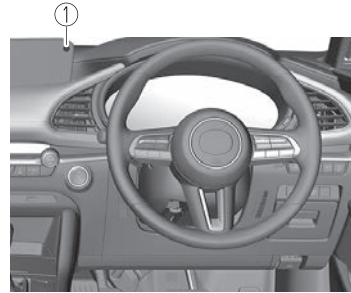

1. Driver monitoring camera

NOTE

- Driver Monitoring (DM) and the earlier collision warning may not operate normally under the following conditions.
 - The driver monitoring camera is covered with something.
 - You are driving the vehicle while leaning on the steering wheel.
 - You are wearing glasses or sunglasses.
 - A cap or hat you are wearing partially blocks the driver monitoring camera's view of your eyes, you have long bangs partially covering your eyes, or a part of your face is invisible due to a face mask.

*Some models. **4-217**

When Driving

i-ACTIVSENSE

- *The lighting conditions change significantly (such as backlight, light from the side, or direct light from the setting sun, and the headlights of on-coming vehicles).*
- *You are driving the vehicle with your face largely pointed to the side.*
- *You are moving around extensively.*
- *Your face or your eyes frequently turn in direction other than straight ahead (direction of travel).*
- *Your line of sight moves or directly after it has moved.*
- *There is a large difference between your line of sight and the direction your face is pointed.*
- *You are driving the vehicle with your head largely tilted to one side.*

4-218

Cruise Control

▼ Cruise Control

With cruise control, you can set and automatically maintain any speed of more than about 30 km/h (19 mph).

WARNING

Do not use the cruise control under the following conditions:

Using the cruise control under the following conditions is dangerous and could result in loss of vehicle control.

- Hilly terrain
- Steep inclines
- Heavy or unsteady traffic
- Slippery or winding roads
- Similar restrictions that require inconsistent speed

▼ Cruise Standby Indication (White)/ Cruise Set Indication (Green)

Cruise standby Indication (White)

The indication turns on (white) when the cruise control system is activated.



Cruise Set Indication (Green)

The indication turns on (green) when a cruising speed has been set.



▼ Activation/Deactivation

WARNING

Always turn off the cruise control system when it is not in use:

Leaving the cruise control system in an activation-ready state while the cruise control is not in use is dangerous as the cruise control could unexpectedly activate if the activation button is accidentally pressed, and result in loss of vehicle control and an accident.

NOTE

When the ignition is switched OFF, the system status before it was turned off is maintained. For example, if the ignition is switched OFF with the cruise control system operable, the system will be operable when the ignition is switched ON the next time.

Activation

To activate the system, press the cruise switch. The cruise standby indication (white) turns on.

Deactivation

To deactivate the system, press the MRCC switch again. The cruise standby indication (white) turns off.

▼ To Set Speed

1. Activate the cruise control system by pressing the cruise switch. The cruise standby indication (white) turns on.
2. Accelerate to the desired speed, which must be more than 25 km/h (16 mph).

Cruise Control

- Adjust the system to the desired vehicle speed using the accelerator pedal. Press the RES switch up (SET+) or down (SET-) to start cruise control. The cruise control indication (green) in the instrument cluster turns on at the same time. Quickly release the switch when the cruise control indication (green) turns on.

NOTE

- If the RES switch is operated up (SET+) or down (SET-) while the vehicle speed is between 25 km/h (16 mph) and 30 km/h (19 mph), the set speed is set to 30 km/h (19 mph).
- The cruise control speed setting cannot be performed under the following conditions:
 - Any of the doors is opened.
 - The driver's seat belt is unfastened.
 - The brake pedal is depressed.
 - The parking brake is applied.
 - (Automatic transmission)**
The selector lever is in the P or N position.
 - (Manual transmission)**
The shift lever is in the neutral position.
- On a steep grade, the vehicle may momentarily slow down while ascending or speed up while descending.
- The cruise control will cancel if the vehicle speed decreases below 20 km/h (12 mph) when the cruise control is activated, such as when climbing a steep grade.

The vehicle speed preset using the cruise control is displayed in the instrument cluster and the active driving display (vehicles with active driving display).

4-220

Instrument cluster (Basic display)



Instrument cluster (i-ACTIVSENSE display)

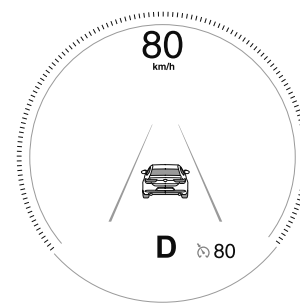

Active driving display

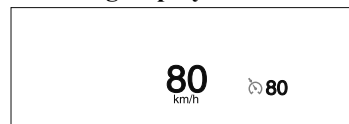

▼ Changing the Set Vehicle Speed

Follow either of these procedures.

To increase/decrease speed using cruise control switch

When the RES switch is pressed up (SET+), the vehicle accelerates and when the RES switch is pressed down (SET-), it decelerates.

- Press and release immediately: 1 km/h (1 mph)

- Press and hold: 10 km/h (5 mph)

NOTE

Even after releasing the RES switch, the cruise control accelerates/decelerates continuously until the set speed displayed in the instrument cluster and on the active driving display is reached. If you want to stop accelerating/decelerating, change the set speed or cancel the system (such as by depressing the brake pedal).

To increase speed using accelerator pedal

Depress the accelerator pedal and press the RES switch up (SET+) or down (SET-) at the desired speed. If the switch is not operated, the system returns to the set speed after you release your foot from the accelerator pedal.

NOTE

Accelerate if you want to speed up temporarily when the cruise control is on. Greater speed will not interfere with or change the set speed. Take your foot off the accelerator to return to the set speed.

▼ To Resume Cruising Speed at More Than 30 km/h (19 mph)

If the cruise control system is temporarily cancelled (such as by applying the brake pedal) and the system is still activated, the most recent set speed will automatically resume when the RES switch is pressed. If vehicle speed is below 30 km/h (19 mph), increase the vehicle speed up to 30 km/h (19 mph) or more and press the RES switch.

▼ To Temporarily Cancel

To temporarily cancel the system, use one of these methods:

- Slightly depress the brake pedal.
- Press the CANCEL switch.
- **(Manual transmission)**
Depress the clutch pedal.

If the RES switch is pressed when the vehicle speed is 30 km/h (19 mph) or higher, the system reverts to the previously set speed.

NOTE

- *If any of the following conditions occur, the cruise control system is temporarily cancelled.*
 - *Even when the brake pedal is slightly depressed.*
 - *The DSC is operating.*
 - *There is a problem in the system.*
 - *Any of the doors is opened.*
 - *The driver's seat belt is unfastened.*
 - *The parking brake is applied.*
- **(Automatic transmission)**
The selector lever is in the P or N position.
- **(Manual transmission)**
The shift lever is in the neutral position.
- *When the cruise control system is temporarily cancelled by even one of the applicable cancel conditions, the speed cannot be re-set.*

When Driving

Cruise Control

· ***(Automatic transmission)***

The cruise control cannot be cancelled while driving in manual mode (selector lever shifted from D to M position).

Therefore, engine braking will not be applied even if the transmission is shifted down to a lower gear. If deceleration is required, lower the set speed or depress the brake pedal.

▼ **To Deactivate**

Press the MRCC switch again.

Tyre Pressure Monitoring System

Tyre Pressure Monitoring System

▼ Tyre Pressure Monitoring System

The TPMS monitors the air pressure of each tyre and if it decreases below the specified value, the system notifies the driver by turning on the TPMS warning light in the instrument cluster and indicating a message on the multi-information display.

For the TPMS, the air pressure data sent from the tyre pressure sensors installed on each wheel via radio signal is received by the receiver unit in the vehicle to monitor the tyre pressures.

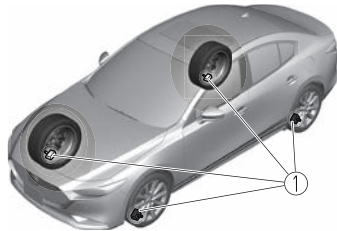

1. Tyre pressure sensors

In addition, the current tyre pressures can be checked using the centre display. Refer to the Vehicle Status Monitor section in the MZD Connect Owner's Manual.

NOTE

· When the ambient temperature is low, the tyre temperatures also decrease. If the tyre temperatures decrease, the air pressure in the tyres will also decrease which could turn on the TPMS warning light.

· Before driving, visually inspect the tyres for abnormalities. Additionally, inspect the tyre pressures monthly. A digital type air pressure gauge is recommended for inspecting the tyre pressures.

The TPMS is not a substitute for your own periodic inspection of the tyres. Always inspect the tyres yourself periodically.

⚠ CAUTION

➤ Each tyre, including the spare (if provided), should be checked monthly when cold and inflated to the inflation pressure recommended by the vehicle manufacturer on the vehicle placard or tyre inflation pressure label. (If your vehicle has tyres of a different size than the size indicated on the vehicle placard or tyre inflation pressure label, you should determine the proper tyre inflation pressure for those tyres.) As an added safety feature, your vehicle has been equipped with a tyre pressure monitoring system (TPMS) that illuminates a low tyre pressure telltale when one or more of your tyres is significantly under-inflated. Accordingly, when the low tyre pressure telltale illuminates, you should stop and check your tyres as soon as possible, and inflate them to the proper pressure. Driving on a significantly under-inflated tyre causes the tyre to overheat and can lead to tyre failure. Under-inflation also reduces fuel efficiency and tyre tread life, and may affect the vehicle's handling and stopping ability.

Tyre Pressure Monitoring System

Please note that the TPMS is not a substitute for proper tyre maintenance, and it is the driver's responsibility to maintain correct tyre pressure, even if under-inflation has not reached the level to trigger illumination of the TPMS low tyre pressure telltale.

Your vehicle has also been equipped with a TPMS malfunction indicator to indicate when the system is not operating properly.

The TPMS malfunction indicator is combined with the low tyre pressure telltale. When the system detects a malfunction, the telltale will flash for approximately one minute and then remain continuously illuminated. This sequence will continue upon subsequent vehicle start-ups as long as the malfunction exists. When the malfunction indicator is illuminated, the system may not be able to detect or signal low tyre pressure as intended. TPMS malfunctions may occur for a variety of reasons, including the installation of replacement or alternate tyres or wheels on the vehicle that prevent the TPMS from functioning properly. Always check the TPMS malfunction telltale after replacing one or more tyres or wheels on your vehicle to ensure that the replacement or alternate tyres and wheels allow the TPMS to continue to function properly.

- *To avoid false readings, the system samples for a little while before indicating a problem. As a result it will not instantaneously register a rapid tyre deflation or blow out.*

▼ If there is a problem with the tyre pressure monitoring system

If the TPMS warning light flashes, there may be a problem with the system.

Consult an Authorised Mazda Dealer to have the system inspected.

Refer to Tyre Pressure Monitoring System (TPMS) Warning Indication/Warning Light (Flashing) on page 7-29.

In the following cases, the system cannot recognise the tyre pressures correctly and the TPMS warning light may flash.

- There is equipment or a device nearby emitting radio signals the same as a tyre pressure sensor.
- A metallic object such as a non-genuine electronic device is installed near the centre of the instrument panel (obstructs the radio signals from the tyre pressure sensors to the receiver).
- A device such as one of the following is used in the cabin.
 - Electronic devices such as a computer.
 - Converter devices such as a DC-AC converter.
- There is a large accumulation of snow or ice around the vehicle tyres.
- The battery in a tyre pressure sensor is dead.
- A wheel not equipped with a tyre pressure sensor is used.
- Tyres employing steel in the sidewall of the tyre are installed.
- Tyre chains are used.

▼ When a tyre pressure decreases

If the TPMS warning light turns on, a tyre pressure may be low. Inspect the tyre pressures and adjust them to the correct inflation pressure.

Tyre Pressure Monitoring System

Refer to Tyre Pressure Monitoring System (TPMS) Warning Indication/Warning Light (Turns on) on page 7-32.

▼ Tyres and Wheels



When inspecting/adjusting the tyre pressures, do not apply excessive force to the air valve of the tyre pressure sensor. Otherwise, the tyre pressure sensor could be damaged.

When changing tyres and wheels

When changing the tyres or wheels (such as installing winter tyres), it will be necessary to register the ID signal code of the tyre pressure sensor to the TPMS. Have an Authorised Mazda Dealer do the registration or register the ID signal codes of the tyre pressure sensors using the following procedure.

NOTE

The tyre pressure sensors on each wheel have a unique ID signal code. For the TPMS to operate correctly, the ID signal codes of the tyre pressure sensors need to be registered to the system.

1. Wait about 15 minutes after changing a tyre or wheel.
2. After 15 minutes have passed, drive the vehicle at a speed of about 25 km/h (16 mph) or faster for 3 minutes or longer. While driving, the ID signal codes of the tyre pressure sensors are automatically registered.

NOTE

If you drive the vehicle within 15 minutes of changing a tyre or wheel, the TPMS warning light will flash because the ID signal codes for the tyre pressure sensors were not registered. In this case, stop the vehicle and register the ID signal codes of the tyre pressure sensors following the procedure.

When replacing tyres and wheels



- *When replacing the tyres and wheels, consult an Authorised Mazda Dealer. Otherwise, the tyre pressure sensors could be damaged when replacing them.*
- *Do not install non-genuine wheels. If wheels other than genuine ones are installed, it may not be possible to install the tyre pressure sensors.*

When replacing a tyre or wheel, always install the tyre pressure sensor. The following combinations of tyres, wheels, or tyres and wheels are possible.

- The tyre pressure sensor from the old wheel is removed and it is installed to the new wheel.
- Only a tyre is replaced without replacing the tyre pressure sensor and wheel.
- A new tyre pressure sensor is installed to a new wheel.

When Driving

Tyre Pressure Monitoring System

NOTE

When installing a new tyre pressure sensor, the ID signal code for the tyre pressure sensor needs to be registered. For details on purchasing a tyre pressure sensor and registering the ID signal of the tyre pressure sensor, consult an Authorised Mazda Dealer.

4-226

Rear View Monitor

Rear View Monitor*

▼ Rear View Monitor

The rear view monitor provides visual images of the rear of the vehicle when reversing.

WARNING

Always drive carefully confirming the safety of the rear and the surrounding conditions by looking directly with your eyes:

Reversing the vehicle by only looking at the screen is dangerous as it may cause an accident or a collision with an object. The rear view monitor is only a visual assist device when reversing the vehicle. The images on the screen may be different from the actual conditions.

CAUTION

➤ Do not use the rear view monitor under the following conditions: Using the rear view monitor under the following conditions is dangerous and could result in injury or vehicle damage or both.

- Icy or snow-covered roads.
- Tyre chains or a temporary spare tyre is installed.
- The vehicle is on a road incline.

➤ When the display is cold, images may course across the monitor or the screen and may be dimmer than usual, which could cause difficulty in confirming the surrounding conditions of the vehicle. Always drive carefully confirming the safety of the rear and the surrounding conditions by looking directly with your eyes.

- Do not apply excessive force to the camera. The camera position and angle may deviate.
- Do not disassemble, modify, or remove it as it may no longer be waterproof.
- The camera cover is made of plastic. Do not apply degreasing agents, organic solvents, wax, or glass coating agents to the camera cover. If any are spilled on the cover, wipe off with a soft cloth immediately.
- Do not rub the camera cover forcefully with an abrasive or hard brush. The camera cover or lens may be scratched which might affect the images.

NOTE

- If water, snow, or mud is stuck on the camera lens, wipe it off using a soft cloth. If it cannot be wiped off, use a mild detergent.
- If the camera temperature changes rapidly (Hot to cold, cold to hot), the rear view monitor may not operate correctly.
- When replacing the tyres, consult an expert repairer, we recommend an Authorised Mazda Repairer. Replacing the tyres could result in deviation of the guide lines which appear on the display.

*Some models. **4-227**

Rear View Monitor

- If the vehicle's front, side, or rear has been involved in a collision, the alignment of the rear view parking camera (location, installation angle) may have deviated. Always consult an expert repairer, we recommend an Authorised Mazda Repairer to have the vehicle inspected.
- If "No camera signal." is indicated in the display, there could be a problem with the camera. Have your vehicle inspected at an expert repairer, we recommend an Authorised Mazda Repairer.

▼ Rear View Parking Camera Location

Saloon



1. Rear view parking camera

Hatchback



1. Rear view parking camera

▼ Switching to the Rear View Monitor Display

Shift the shift lever (manual transmission) or the selector lever (automatic transmission) to reverse (R) position with the ignition switched ON to switch the display to the rear view monitor display.

NOTE

When the shift lever (manual transmission) or the selector lever (automatic transmission) is shifted from reverse (R) position to another shift lever (manual transmission) or the selector lever (automatic transmission) position, the screen returns to the previous display.

▼ **Displayable Range on the Screen**

The images on the screen may be different from the actual conditions.

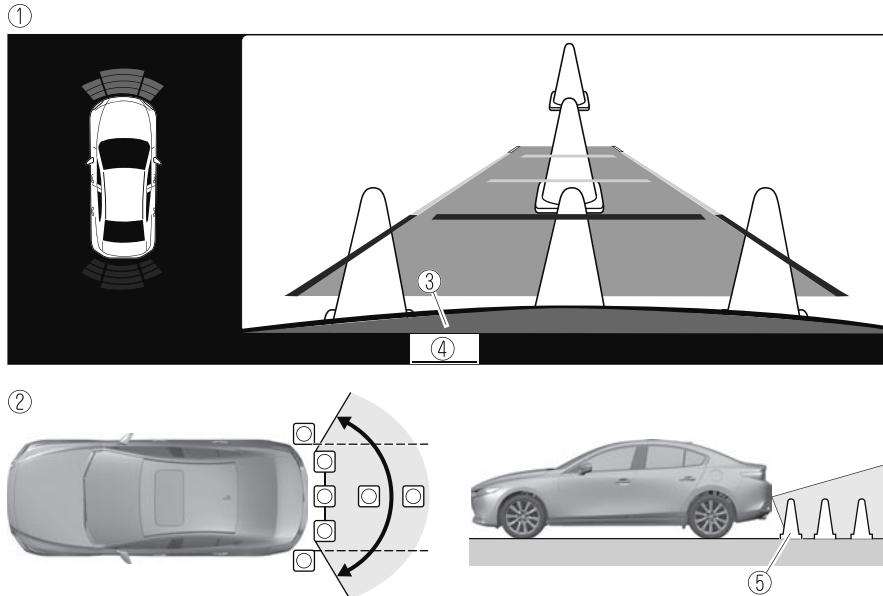

1. (Screen display)
2. (Actual view)
3. Bumper
4. "Check surroundings for safety." message is displayed
5. Object

NOTE

- The displayable range varies depending on the vehicle and road conditions.
- If the camera lens is touched or there is any dirt on it, it could affect the screen image. Wipe the lens using a soft cloth.
- The displayable range is limited. Objects under the bumper or around the bumper ends cannot be displayed.
- The distance appearing in the displayed image is different from the actual distance because the rear view parking camera is equipped with a specific lens.
- Images displayed on the monitor from the rear view parking camera are reversed images (mirror images).
- Some optionally installed vehicle accessories may be picked up by the camera. Do not install any optional parts that can interfere with the camera view, such as illuminating parts or parts made of reflective material.

When Driving

Rear View Monitor

· It may be difficult to see the display under the following conditions, however, it does not indicate a malfunction.

- In darkened areas.
- When the temperature around the lens is high/low.
- When the camera is wet such as on a rainy day or during periods of high humidity.
- When foreign material such as mud is stuck around the camera.
- When the camera lens reflects sunlight or headlight beams.
- The surroundings are illuminated by vehicle lights, fluorescent lights, or LED lights (Display may flicker).
- Extremely small dark or white dots appear on the screen (dots may flicker).
- Image display may be delayed if the temperature around the camera is low.

▼ Viewing the Display

Guide lines which indicate the width of the vehicle (yellow) are displayed on the screen as a reference to the approximate width of the vehicle in comparison to the width of the parking space you are about to back into.

Use this display view for parking your vehicle in a parking space or garage.

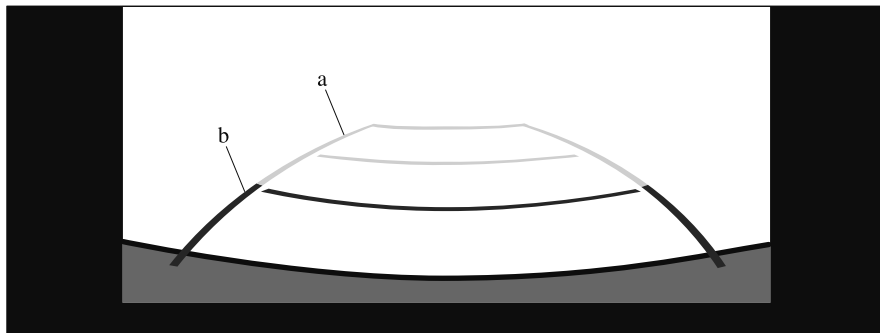

a) Vehicle width guide lines (yellow)

Guide lines serve as a reference to the approximate width of the vehicle.

b) Distance guide lines

These guide lines indicate the approximate distance to a point measured from the vehicle's rear (from the end of the bumper).

The red and yellow lines indicate the points about 50 cm (19 in) for the red line and 100 cm (39.3 in) for the yellow lines from the rear bumper (at the centre point of each of the lines).

4-230

When Driving
Rear View Monitor

 **CAUTION**

The guide lines on the screen are fixed lines. They are not synced to the driver's turning of the steering wheel. Always be careful and check the area to the vehicle's rear and the surrounding area directly with your eyes while backing up.

▼ Rear View Monitor Operation

The operation of the rear view monitor when reversing the vehicle varies depending on the traffic, road, and vehicle conditions. The amount of steering and the timing also varies depending on conditions, so confirm the surrounding conditions directly with your eyes and steer the vehicle in accordance with the conditions.

Be well aware of the above cautions prior to using the rear view monitor.

NOTE

Images displayed on the monitor from the rear view parking camera are reversed images (mirror images).

When Driving

Rear View Monitor

1. Shift the shift lever (manual transmission) or the selector lever (automatic transmission) to reverse (R) position to switch the display to the rear view monitor display.
2. Confirming the surrounding conditions, reverse the vehicle.

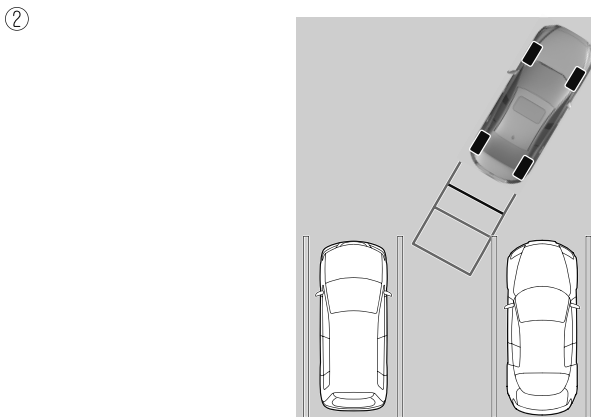
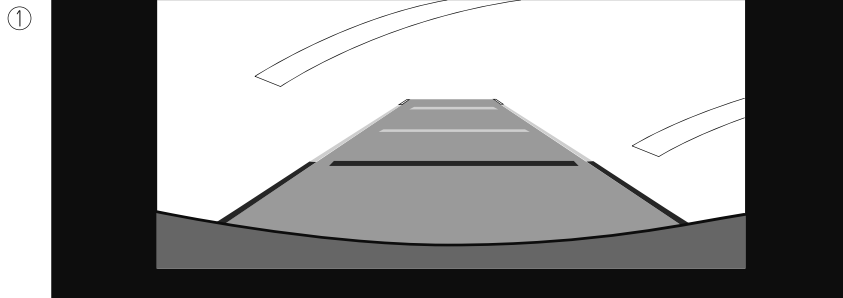

1. (Display condition)
2. (Vehicle condition)
3. After your vehicle begins entering the parking space, continue backing up slowly so that the distance between the vehicle width lines and the sides of the parking space on the left and right are roughly equal.
4. Continue to adjust the steering wheel until the vehicle width guide lines are parallel to the left and right sides of the parking space.

4-232

When Driving
Rear View Monitor

5. Once they are parallel, straighten the wheels and back your vehicle slowly into the parking space. Continue checking the vehicle's surroundings and then stop the vehicle in the best possible position. (If the parking space has division lines, check whether the vehicle width guide lines are parallel to them.)

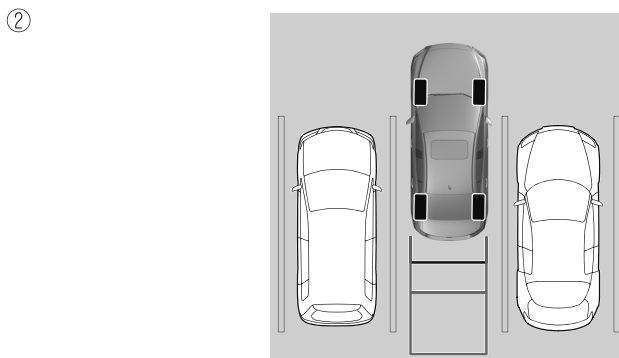
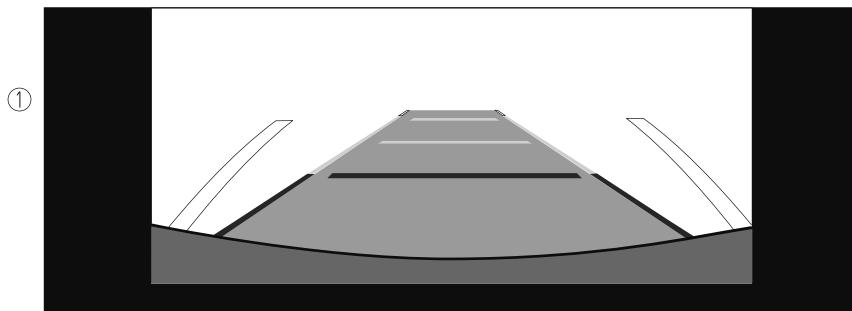

1. (Display condition)
 2. (Vehicle condition)
6. When the shift lever (manual transmission) or the selector lever (automatic transmission) is shifted from reverse (R) position to another shift lever (manual transmission) or the selector lever (automatic transmission) position, the screen returns to the previous display.

NOTE

Because there may be a difference between the displayed image, such as indicated below, and the actual conditions when parking, always verify the safety at the rear of the vehicle and the surrounding area directly with your eyes.

- *In the image of the parking space (or garage) displayed on the screen, the back end and distance guide lines may appear aligned in the monitor, but they may not actually be aligned on the ground.*

When Driving

Rear View Monitor

- When parking in a space with a division line on only one side of the parking space, the division line and the vehicle width guide line appear aligned in the monitor, but they may not actually be aligned on the ground.

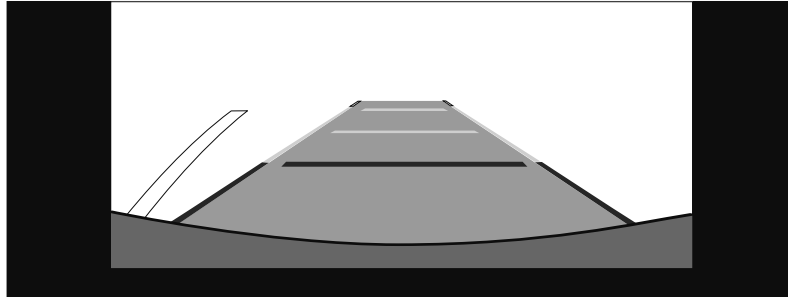

▼ Variance Between Actual Road Conditions and Displayed Image

Some variance occurs between the actual road and the displayed road. Such variance in distance perspective could lead to an accident. Note the following conditions that may cause a variance in distance perspective.

When the vehicle is tilted due to the weight of passengers and load

When the vehicle rear is lowered, the object displayed on the screen appears farther than the actual distance.

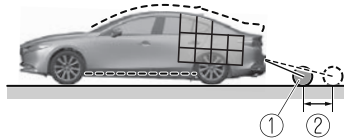

1. Object
2. Variance

When there is a steep grade behind the vehicle

When there is a steep upgrade (downgrade) behind the vehicle, the object displayed on the screen appears farther (downgrade: closer) than the actual distance.

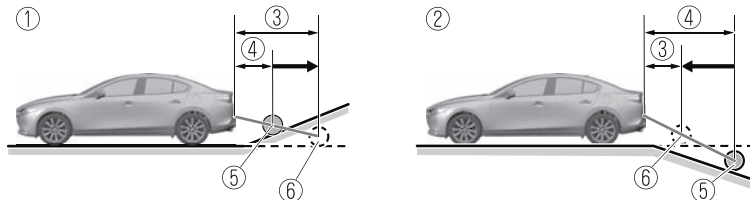

1. Appears farther than actual distance
2. Appears closer than actual distance

4-234

When Driving
Rear View Monitor

3. Distance between the vehicle and object displayed on the screen.
4. Actual distance between the vehicle and object.
5. Object at actual position
6. Object on screen

Three-dimensional object on vehicle rear

Because the distance guide lines are displayed based on a flat surface, the distance to the three-dimensional object displayed on the screen is different from the actual distance.

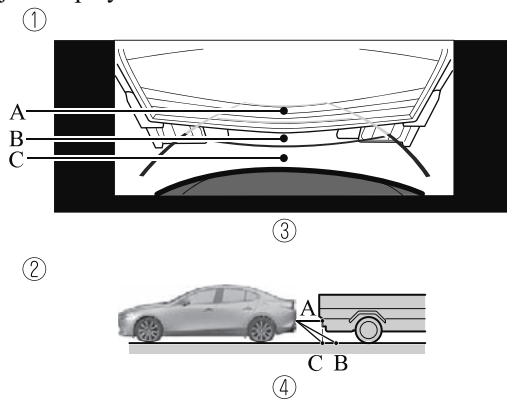

1. (Screen display)
2. (Actual condition)
3. Sensed distance on screen $A > B > C$
4. Actual distance $B > C = A$

When Driving

Parking Sensor System

Parking Sensor System*

▼ Parking Sensor System

The parking sensors use ultrasonic sensors which detect obstructions around the vehicle when the vehicle is driven at low speeds, such as during garage or parallel parking, and a buzzer sound and detection indicator notify the driver of the approximate distance from the vehicle to the surrounding obstruction.

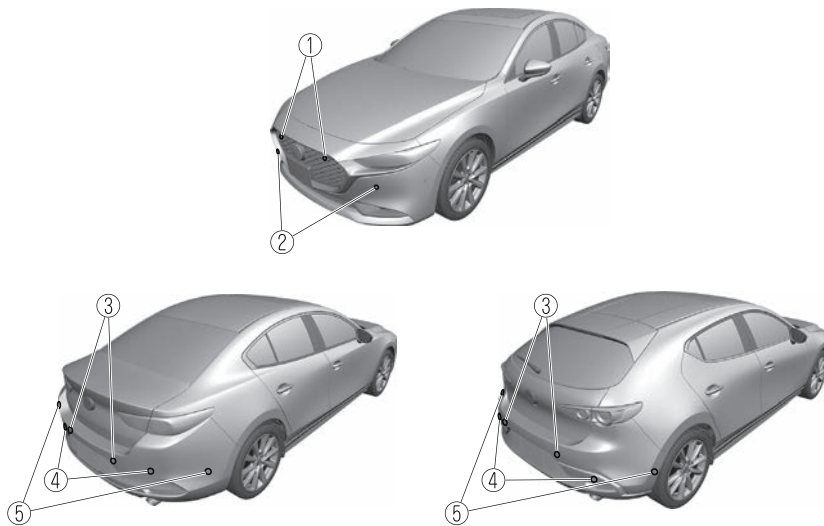

1. Front ultrasonic sensor*
2. Front corner ultrasonic sensor*
3. Rear ultrasonic sensor
4. Rear corner ultrasonic sensor
5. Rear side ultrasonic sensor*

⚠ WARNING

Do not rely completely on the parking sensor system and be sure to confirm the safety around your vehicle visually when driving:

This system can assist the driver in operating the vehicle in the forward and backward directions while parking. The detection ranges of the sensors are limited, therefore, driving the vehicle while relying only on the system may cause an accident. Always confirm the safety around your vehicle visually when driving.

4-236 *Some models.

Parking Sensor System

CAUTION

- Do not install any accessories within the detection ranges of the sensors. It may affect the system operation.
- Depending on the type of obstruction and the surrounding conditions, the detection range of a sensor may narrow, or the sensors may not be able to detect obstructions.

NOTE

- The system may not operate normally under the following conditions:
 - Mud, ice, or snow is adhering to the sensor area (Returns to normal operation when removed).
 - The sensor area is frozen (Returns to normal operation when the ice is thawed).
 - The sensor is covered by a hand.
 - The sensor is excessively shocked.
 - The vehicle is excessively tilted.
 - Under extremely hot or cold weather conditions.
 - The vehicle is driven on bumps, inclines, gravel, grating, or grass covered roads.
 - Anything which generates ultrasonic waves such as another vehicle's horn, the engine sound of a motorcycle, the air brake sound of a large-sized vehicle, or another vehicle's sensors approaches the vehicle.
 - The vehicle is driven in heavy rain or in road conditions causing water-splash.
 - A commercially-available wing pole or an aerial for a radio transmitter is installed to the vehicle.
 - The vehicle is moving towards a tall or square curbstone, or a steep grade.
 - An obstruction is too close to the sensor.
 - The vehicle is moving towards an uneven wall or stairs.
 - There are multiple obstructions.
 - The vehicle is driven in a place with low ceilings.
- Obstructions under the bumper cannot be detected. Obstructions which are lower than the sensor or thin may not be detected even though they were detected once.
- The following types of obstructions may not be detected:
 - Thin objects such as wire, rope or poles
 - Things which absorb sonic waves easily such as cotton or snow
 - Angular shaped objects
 - Very tall objects, and those which are wide at the top
 - Small, short objects
- Always have the system inspected at an expert repairer, we recommend an Authorised Mazda Repairer if any shock is applied to the bumpers, even in a minor accident. If the sensors are deviated, they cannot detect obstructions.

When Driving

Parking Sensor System

- The system may have a malfunction if the indicator light does not turn on even when the parking sensor switch is turned on. Have your vehicle inspected by an expert repairer, we recommend an Authorised Mazda Repairer.
- The system may have a malfunction if a message indicating a system malfunction is displayed. Have your vehicle inspected by an expert repairer, we recommend an Authorised Mazda Repairer.
- A message may be displayed even when the ambient temperature is extremely cold, or mud, ice, or snow adheres to the sensor area. Remove any foreign matter from the sensor area.
- When installing a trailer hitch, consult an expert repairer, we recommend an Authorised Mazda Repairer.
- If a Mazda genuine trailer hitch is used, the rear side of the parking sensor system is automatically turned off.

▼ Sensor Detection Range

The sensors detect obstructions within the following range.

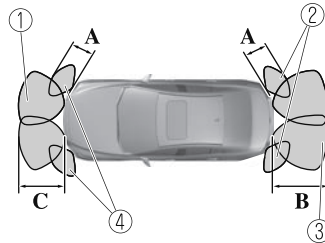







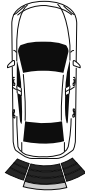
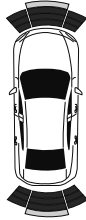

1. Front ultrasonic sensor detection range
 2. Rear corner/Rear side ultrasonic sensor detection range
 3. Rear ultrasonic sensor detection range
 4. Front corner ultrasonic sensor detection range
- A: About 55.0 cm (About 21.6 in)
B: About 150 cm (About 59.0 in)
C: About 100 cm (About 39.3 in)

Viewing distance display

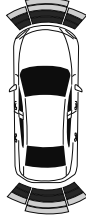
4-238

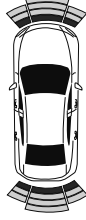
When Driving
Parking Sensor System

Display			Distance between vehicle and obstruction	
Without 360° view monitor		With 360° view monitor	Front ultrasonic sensor*/Front corner ultrasonic sensor*	Rear ultrasonic sensor/Rear corner ultrasonic sensor/Rear side ultrasonic sensor*
Without front ultrasonic sensor and front corner ultrasonic sensor	With front ultrasonic sensor and front corner ultrasonic sensor			
		Green 	Front ultrasonic sensor: Approx. 100—60.0 cm (39.3—23.6 in)	Rear ultrasonic sensor: Approx. 150—60.0 cm (59.0—23.6 in)
		Yellow 	Front ultrasonic sensor: Approx. 60.0—45.0 cm (23.6—17.7 in) Front corner ultrasonic sensor: Approx. 55.0—38.0 cm (21.6—14.9 in)	Rear ultrasonic sensor: Approx. 60.0—45.0 cm (23.6—17.7 in) Rear corner ultrasonic sensor/Rear side ultrasonic sensor: Approx. 55.0—38.0 cm (21.6—14.9 in)
		Amber 	Front ultrasonic sensor: Approx. 45.0—35.0 cm (17.7—13.7 in) Front corner ultrasonic sensor: Approx. 38.0—25 cm (14.9—9.8 in)	Rear ultrasonic sensor: Approx. 45.0—35.0 cm (17.7—13.7 in) Rear corner ultrasonic sensor/Rear side ultrasonic sensor: Approx. 38.0—25 cm (14.9—9.8 in)
		Red 	Front ultrasonic sensor: Within approx. 35.0 cm (13.7 in) Front corner ultrasonic sensor: Within approx. 25 cm (9.8 in)	Rear ultrasonic sensor: Within approx. 35.0 cm (13.7 in) Rear corner ultrasonic sensor/Rear side ultrasonic sensor: Within approx. 25 cm (9.8 in)

*Some models. **4-239**

Parking Sensor System

▼ Park Assist Sensor System Operation

When the parking sensor switch is pressed with the ignition switched ON, the buzzer sounds and the indicator light turns on. When the ignition is switched ON with the parking sensor activated, the indicator light turns on.

Press the switch again to stop the operation.



1. Indicator light

NOTE

When the ignition is switched OFF, the system status before it was turned off is maintained. For example, if the ignition is switched OFF while the parking sensor is activated, the system will be activated when the ignition is switched ON the next time.

Operation conditions

The parking sensor system can be used when all of the following conditions are met:

- The ignition is switched ON.
- The parking sensor switch is turned on.

NOTE

· (Automatic vehicle)

The detection indicator and buzzer of the front sensors/front corner sensors do not operate when the selector lever is in the P position.

- The detection indicator and buzzer sound do not activate when the parking brake is applied.

▼ Obstruction Detection Indication

The position of a sensor which has detected an obstruction is indicated. The gauge illuminates in different areas depending on the distance to an obstruction detected by the sensor. As the vehicle approaches closer to an obstruction, the zone in the gauge closer to the vehicle illuminates.

Without 360°view monitor

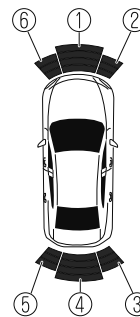

1. Front ultrasonic sensor gauge*
2. Right front corner ultrasonic sensor gauge*
3. Right rear corner ultrasonic sensor gauge/Right rear side ultrasonic sensor gauge*
4. Rear ultrasonic sensor gauge
5. Left rear corner ultrasonic sensor gauge/Left rear side ultrasonic sensor gauge*

Parking Sensor System

6. Left front corner ultrasonic sensor gauge*

With 360°view monitor

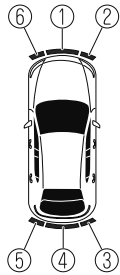

1. Front ultrasonic sensor gauge
2. Right front corner ultrasonic sensor gauge
3. Right rear corner ultrasonic sensor gauge/Right rear side ultrasonic sensor gauge*
4. Rear ultrasonic sensor gauge
5. Left rear corner ultrasonic sensor gauge/Left rear side ultrasonic sensor gauge*
6. Left front corner ultrasonic sensor gauge

NOTE

The detection indicator can switch between display and non-display. Refer to the Settings section in the MZD Connect Owner's Manual.

System problem notification

The indication displays if the system has a malfunction.

Without 360°view monitor



With 360°view monitor



Check the reason for the indication displaying on the centre display or multi-information display. Refer to If a Warning Light Turns On or Flashes on page 7-23.

*Some models. **4-241**

Parking Sensor System

▼ Parking Sensor Warning Beep

Informs the driver of the approximate distance from the vehicle to the obstruction using warning beeps depending on the distance. If multiple obstructions are detected at the same time, warning beeps are activated according to the distance to the nearest obstruction. The warning beeps are activated as follows while the system is operating. However, the warning beeps are not activated while the seat belt reminder is operating.

Front ultrasonic sensor*, Rear ultrasonic sensor

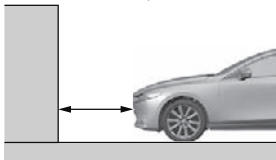
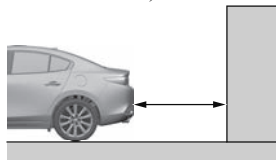
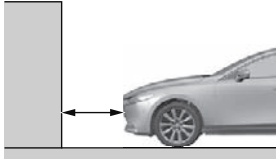
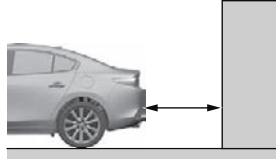
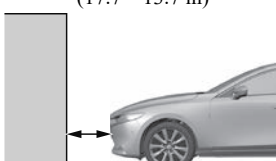
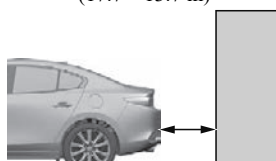
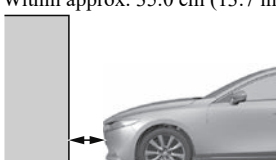
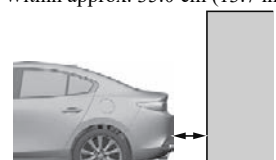
Distance Detection area	Distance between vehicle and obstruction		Beeper sound* ¹
	Front ultrasonic sensor	Rear ultrasonic sensor	
Farthest distance	Approx. 100—60.0 cm (39.3—23.6 in) 	Approx. 150—60.0 cm (59.0—23.6 in) 	Slow intermittent sound
Far distance	Approx. 60.0—45.0 cm (23.6—17.7 in) 	Approx. 60.0—45.0 cm (23.6—17.7 in) 	Medium intermittent sound
Middle distance	Approx. 45.0—35.0 cm (17.7—13.7 in) 	Approx. 45.0—35.0 cm (17.7—13.7 in) 	Fast intermittent sound
Close distance	Within approx. 35.0 cm (13.7 in) 	Within approx. 35.0 cm (13.7 in) 	Continuous sound

4-242 *Some models.

When Driving

Parking Sensor System

*1 The rate at which the intermittent sound beeps increases as the vehicle approaches the obstruction.

Front corner ultrasonic sensor*, Rear corner/Rear side* ultrasonic sensor

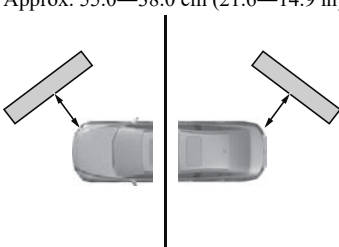
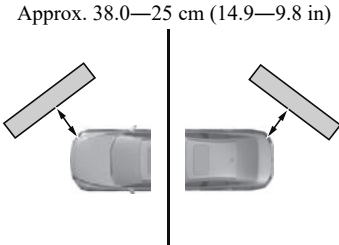
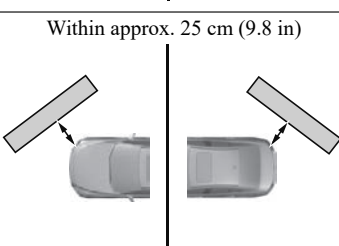
Distance Detection area	Distance between vehicle and obstruction	Beeper sound* ¹
	Front corner ultrasonic sensor/Rear corner, Rear side ultrasonic sensor	
Far distance	<p>Approx. 55.0—38.0 cm (21.6—14.9 in)</p> 	Medium intermittent sound
Middle distance	<p>Approx. 38.0—25 cm (14.9—9.8 in)</p> 	Fast intermittent sound
Close distance	<p>Within approx. 25 cm (9.8 in)</p> 	Continuous sound

*1 The rate at which the intermittent sound beeps increases as the vehicle approaches the obstruction.

NOTE

- If an obstruction in the same area excluding the close area is detected continuously for 6 seconds or longer, only the warning beeps stop activating. (Detection is indicated) If the detection area changes to the close side, the warning beeps resumes. (If the detection area changes to the far side, the warning beeps remain off)
- The sound volume (each of front and rear) can be changed.
Refer to the Settings section in the MZD Connect Owner's Manual.

*Some models. **4-243**

When Driving

Parking Sensor System

▼ When Warning Indicator/Beep is Activated

The system notifies the driver of an abnormality by activating the beep sound and the indicator light.

Indicator/Beep	How to check
A message indicating a system malfunction or sensor malfunction is displayed.	There may be a problem with the system. Have your vehicle inspected by an expert repairer, we recommend an Authorised Mazda Repairer as soon as possible.
A message indicating that the sensor is dirty is displayed.	Remove any foreign matter from the sensor area. If the system does not recover, have the vehicle inspected by an expert repairer, we recommend an Authorised Mazda Repairer.
A certain obstruction detection indication is continuously displayed.	Foreign matter may have gotten on the sensor area corresponding to the detection indicator. If the system does not recover, have the vehicle inspected by an expert repairer, we recommend an Authorised Mazda Repairer.

5

Interior Features

Use of various features for ride comfort, including air-conditioning system and audio system.

Air-Conditioning System.....	5-2	Interior Equipment.....	5-32
Operating Tips.....	5-2	Sunvisors.....	5-32
Vent Operation.....	5-3	Interior Lights.....	5-33
Manual Type.....	5-5	Accessory Sockets.....	5-36
Fully Automatic Type.....	5-9	Cup Holder.....	5-37
		Bottle Holder.....	5-38
MZD Connect.....	5-14	Assist Grips.....	5-39
What is MZD Connect ?.....	5-14	Rear Coat Hooks.....	5-39
MZD Connect Basic		Storage Compartments.....	5-40
Operations.....	5-17		

Air-Conditioning System

Operating Tips

▼ Operating Tips

- Operate the air-conditioning system with the engine running.
- To prevent the battery from being discharged, do not leave the fan control switch on for a long period of time with the ignition switched ON when the engine is not running.
- The airflow amount may decrease slightly while the i-stop function is operating.
- Clear all obstructions such as leaves, snow and ice from the bonnet and the air inlet in the cowl grille to improve the system efficiency.
- Use the air-conditioning system to defog the windows and dehumidify the air.
- The recirculate mode should be used when driving through tunnels or while in a traffic jam, or when you would like to shut off outside air for quick cooling of the interior.
- Use the outside air position for ventilation or windscreen defrosting.
- If the vehicle has been parked in direct sunlight during hot weather, open the windows to let warm air escape, then run the air-conditioning system.
- Run the air conditioner about 10 minutes at least once a month to keep internal parts lubricated.

- Have the air conditioner checked before the weather gets hot. Lack of refrigerant may make the air conditioner less efficient.

The refrigerant specifications are indicated on a label attached to the inside of the engine compartment. If the wrong type of refrigerant is used, it could result in a serious malfunction of the air conditioner. Consult a professional, government certified repairer for the inspection or repair because a special device is required for the air conditioner maintenance. For details, consult an expert repairer, we recommend an Authorised Mazda Repairer.

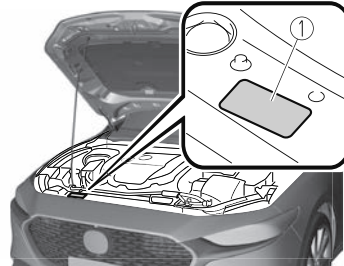

1. Label

Air-Conditioning System

Vent Operation

▼ Adjusting the Vents

Directing airflow

To adjust the direction of airflow, move the adjustment knob.

NOTE

- When using the air conditioner under humid ambient temperature conditions, the system may blow fog from the vents. This is not a sign of trouble but a result of humid air being suddenly cooled.
- The air vents can be fully opened and closed by operating the knob.

Driver's Side Vents

Air vent open/close

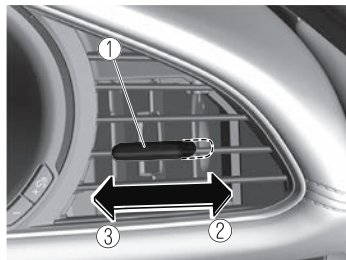

1. Knob
2. Close
3. Open

Airflow direction adjustment

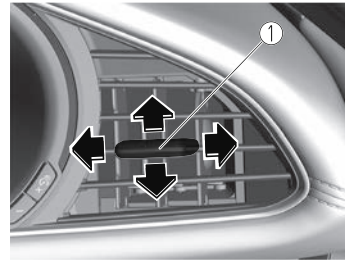

1. Knob

Passenger's Side Vents

Air vent open/close

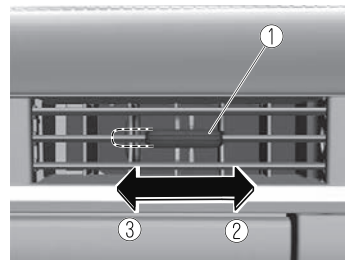

1. Knob
2. Open
3. Close

Airflow direction adjustment

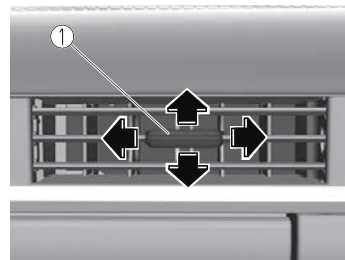

1. Knob

Air-Conditioning System

Rear Vents*

Air vent open/close

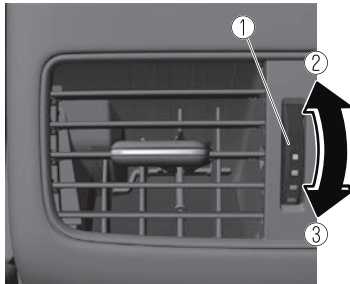

1. Dial
2. Open
3. Close

Airflow direction adjustment

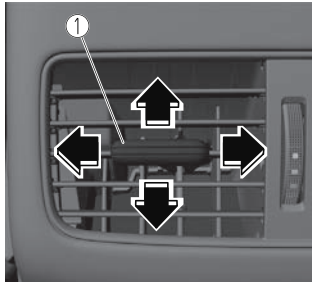

1. Knob

▼ Selecting the Airflow Mode

Instrument panel Vents

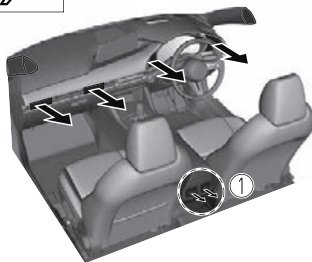

1. With rear vents

Defroster and Floor Vents

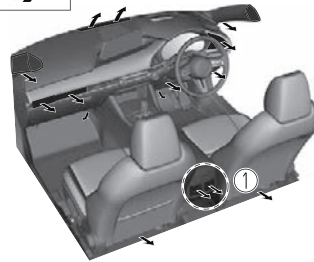

1. With rear vents

Instrument panel and Floor Vents

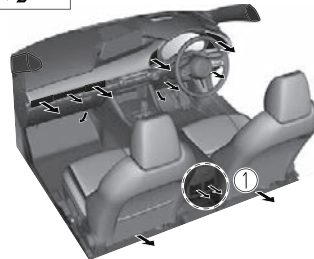

1. With rear vents

Defroster Vents



Air-Conditioning System

Floor Vents

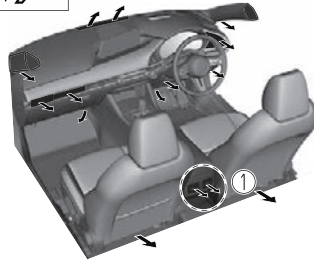

1. With rear vents

NOTE

The location airflow exits the air vents and the airflow amount may change depending on the open or close status of the air vents.

Manual Type

▼ Manual Type

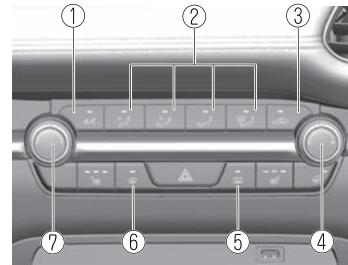

1. A/C switch
2. Mode selector switch
3. Air intake selector switch
4. Fan control dial
5. Rear window defogger switch
6. Windscreen defroster switch
7. Temperature control dial

▼ Control Switches

Temperature control dial

This dial controls temperature. Turn it clockwise for hot and anticlockwise for cold.

Fan control dial

This dial allows variable fan speeds. The fan has seven speeds.

Mode selector switches

The desired airflow mode can be selected (page 5-4).

Air-Conditioning System

A/C switch

Press the A/C switch to turn the air conditioner on. The indicator light on the switch will illuminate when the fan control dial is in any position except OFF.

Press the switch once again to turn the air conditioner off.

NOTE

The air conditioner may not function when the outside temperature approaches 0 °C (32 °F).

Air intake selector switch

This switch controls the source of air entering the vehicle.

Outside or recirculated air positions can be selected. Press the switch to select outside/recirculated air positions.

Recirculated air position (indicator light illuminated)

Outside air is shut off. Use this position when going through tunnels, driving in congested traffic (high engine exhaust areas) or when quick cooling is desired.

Outside air position (indicator light turned off)

Outside air is allowed to enter the cabin. Use this mode for ventilation or windscreen defrosting.

WARNING

Do not use the position (indicator light turns on) in cold or rainy weather:

Using the  position (indicator light turns on) in cold or rainy weather is dangerous as it will cause the windows to fog up. Your vision will be hampered, which could lead to a serious accident.

Windscreen defroster switch

Press the switch to defrost the windscreen and front door windows.

Refer to Windscreen Defrosting and Defogging on page 5-7.

Rear window defogger switch



Press the rear window defogger switch to defrost the rear window.

Refer to Rear Window Defogger on page 4-60.

▼ Heating

1. Press the  switch.
2. Set the air intake selector to the outside air position (indicator light turns off).
3. Set the temperature control dial to the hot position.
4. Set the fan control dial to the desired speed.
5. If dehumidified heating is desired, turn on the air conditioner.

NOTE

- *If the windscreen fogs up easily, press the  switch.*
- *If cooler air is desired at face level, press the  switch and adjust the temperature control dial to maintain maximum comfort.*

Air-Conditioning System

· The air to the floor is warmer than air to the face (except when the temperature control dial is set at the extreme hot or cold position).

▼ Cooling

1. Press the  switch.
2. Set the temperature control dial to the cold position.
3. Set the fan control dial to the desired speed.
4. Turn on the air conditioner by pressing the A/C switch.
5. After cooling begins, adjust the fan control dial and temperature control dial as needed to maintain maximum comfort.

CAUTION

If the air conditioner is used while driving up long hills or in heavy traffic, monitor the high engine coolant temperature warning indication to see if it is displayed (page 7-25).

The air conditioner may cause engine overheating. If the warning indication is displayed, turn the air conditioner off (page 7-17).

NOTE

- When maximum cooling is desired, set the temperature control dial to the extreme cold position and set the air intake selector to the recirculated air position, then turn the fan control dial fully clockwise.
- If warmer air is desired at floor level, press the  switch and adjust the temperature control dial to maintain maximum comfort.

· The air to the floor is warmer than air to the face (except when the temperature control dial is set at the extreme hot or cold position).

▼ Ventilation



1. Press the  switch.
2. Set the air intake selector to the outside air position (indicator light turns off).
3. Set the temperature control dial to the desired position.
4. Set the fan control dial to the desired speed.

▼ Windscreen Defrosting and Defogging

1. Press the  switch.
2. Set the temperature control dial to the desired position.
3. Set the fan control dial to the desired speed.
4. If dehumidified heating is desired, turn on the air conditioner.



WARNING

Do not defog the windscreen using the  switch with the temperature control set to the cold position:

Using the  switch with the temperature control set to the cold position is dangerous as it will cause the outside of the windscreen to fog up. Your vision will be hampered, which could lead to a serious accident. Set the temperature control to the hot or warm position when using the  switch.

Air-Conditioning System

NOTE

- Fogging on the windows clears up more easily while the air conditioner is on, but they will fog up more easily if the air conditioner is turned off.
- Be careful that the windows do not fog up when doing any of the following:
 - Switching to recirculate mode
 - Turning off the air conditioner
- For maximum defrosting, turn on the air conditioner, set the temperature control dial to the extreme hot position, and turn the fan control dial fully clockwise.
- If warm air is desired at the floor, press the  switch.
- With the  switch, the outside air position is automatically selected to defrost the windscreen. The air intake selector cannot be changed to the recirculated air position.

▼ Dehumidifying

Operate the air conditioner in cool or cold weather to help defog the windscreen and side windows.

1. Press the desired mode switch you want to set.
2. Set the air intake selector to the outside air position (indicator light turns off).
3. Set the temperature control dial to the desired position.
4. Set the fan control dial to the desired speed.
5. Turn on the air conditioner by pressing the A/C switch.

NOTE

One of the functions of the air conditioner is dehumidifying the air and, to use this function, the temperature does not have to be set to cold. Therefore, set the temperature control dial to the desired position (hot or cold) and turn on the air conditioner when you want to dehumidify the cabin air.

Air-Conditioning System

Fully Automatic Type

▼ Fully Automatic Type

Air-conditioning system information is displayed on the display.

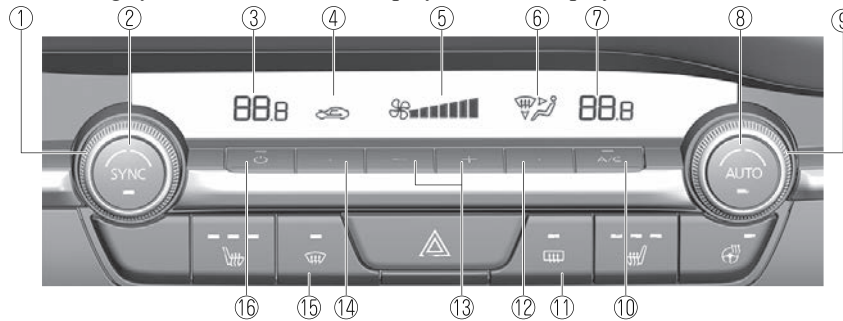

1. Passenger temperature control dial
2. SYNC (synchronized temperature) switch
3. Temperature setting display (passenger's side)
4. Air intake display
5. Airflow display
6. Mode selector display
7. Temperature setting display (driver's side)
8. AUTO switch
9. Driver temperature control dial
10. A/C switch
11. Rear window defogger switch
12. Mode selector switch
13. Fan control switch
14. Air intake selector switch
15. Windscreen defroster switch
16. Power switch

▼ Control Switches

AUTO switch

By pressing the AUTO switch the following functions will be automatically controlled in accordance with the selected set temperature:

- Airflow temperature
- Amount of airflow

- Selection of airflow mode
- Outside/Recirculated air selection
- Air conditioner operation
- Seat warmer level selection*
- Heated steering wheel operation*

NOTE

AUTO switch indicator light

*Some models.

Air-Conditioning System

- When the AUTO switch indicator light is on, it indicates auto operation, and the system will function automatically.
- If any of the following switches are operated while in auto control, the AUTO switch indicator turns off.
 - Mode selector switch
 - Fan control switch
 - Windscreen defroster switchThe functions for switches other than those operated continue to operate in auto control.

Power switch (System On/Off)

The air-conditioning system turns on or off by pressing the power switch.

Temperature control dial

This dial controls temperature. Turn it clockwise for hot and anticlockwise for cold.

- When the SYNC switch is on:
Turn the driver temperature control dial to control the temperature throughout the entire cabin.
- When the SYNC switch is off:
Turn the driver or front passenger temperature control dial to independently control the temperature on each side of the cabin.

NOTE

- The air-conditioning system changes to the individual operation mode (SYNC switch indicator light turns off) by turning the front passenger temperature control dial even when the SYNC switch is on, which allows individual control of the set temperature for the driver and front passenger.

- When you set the temperature to the lower or upper limit, “Lo” or “Hi” is displayed.
- The temperature units for the temperature setting display can be changed in conjunction with the temperature units for the outside temperature display.
Refer to Outside Temperature Display on page 4-26.



Fan control switch

The fan has 7 speeds. The selected speed will be displayed.

Mode selector switch

The desired airflow mode can be selected (page 5-4).

NOTE

- With the airflow mode set to the  position and the temperature control dial set at a medium temperature, heated air is directed to the feet and air at a comparably lower temperature will flow through the central, left and right vents.
- To set the air vent to , press the windscreen defroster switch.
- In the  position, the outside air position is automatically selected.

A/C switch

Pressing the A/C switch while the AUTO switch is turned on will turn off the air conditioner (cooling/dehumidifying functions).

The on/off of the air conditioner switches each time the A/C switch is pressed.

Air-Conditioning System

NOTE

- The air conditioner operates when the A/C switch is pressed while the air conditioner is turned off.
- The air conditioner may not function when the outside temperature approaches 0 °C (32 °F).

Air intake selector switch

Outside or recirculated air positions can be selected. Press the switch to select outside/recirculated air positions.

Recirculated air position (↻)

Outside air is shut off. Use this position when going through tunnels, driving in congested traffic (high engine exhaust areas) or when quick cooling is desired.

Outside air position (↻)

Outside air is allowed to enter the cabin. Use this mode for ventilation or windscreen defrosting.



Do not recirculate the air in the cabin during cold or rainy weather:

Recirculating the air in the cabin during cold and rainy weather is dangerous as it will cause the windows to fog up. Your vision will be hampered, which could lead to a serious accident.

SYNC (Synchronized Temperature) switch

Use the SYNC switch to change the mode between the individual operation (driver and passenger) and interconnection (simultaneous) modes.

Interconnection mode (indicator light turns on)

The set temperature for the driver and front passenger is controlled simultaneously.

Individual operation mode (indicator light turns off)

The set temperature can be controlled individually for the driver and front passenger.

Windscreen defroster switch

Press the switch to defrost the windscreen and front door windows.

Refer to Windscreen Defrosting and Defogging on page 5-12.

Rear window defogger switch

Press the rear window defogger switch to defrost the rear window.

Refer to Rear Window Defogger on page 4-60.

▼ Operation of Automatic Air Conditioner

1. Press the AUTO switch. Selection of the airflow mode, air intake selector and amount of airflow will be automatically controlled.
2. Use the temperature control dial to select a desired temperature.
If you want to set the temperature on the front passenger's side separately from the driver's side, turn the front passenger temperature control dial to switch the mode automatically to the individual operation mode and set the temperature for the front passenger's side.

Air-Conditioning System

To turn off the system, press the power switch.

NOTE

- Turn the temperature control dial to adjust the temperature between 15 °C (60 °F) and 29 °C (84 °F). Set the control dial to the recommended temperature of 22 °C (72 °F), and then adjust it as desired.
- Setting the temperature to maximum hot or cold will not provide the desired temperature at a faster rate.
- When selecting heat, the system will restrict airflow until the engine has warmed to prevent cold air from blowing out of the vents.

▼ Windscreen Defrosting and Defogging

Press the windscreen defroster switch. In this position, the outside air position is automatically selected, and the air conditioner automatically turns on. The air conditioner will directly dehumidify the air to the front windscreen and side windows on page 5-4. Airflow amount will be increased.

⚠ WARNING

Set the temperature control to the hot or warm position when defogging (☀/🔥 position):

Using the ☀/🔥 position with the temperature control set to the cold position is dangerous as it will cause the outside of the windscreen to fog up. Your vision will be hampered, which could lead to a serious accident.

5-12

NOTE

- Fogging on the windows clears up more easily while the air conditioner is on, but they will fog up more easily if the air conditioner is turned off.
- Be careful that the windows do not fog up when doing any of the following:
 - Switching to recirculate mode
 - Turning off the air conditioner
- Use the temperature control dial to increase the air flow temperature and defog the windscreen more quickly.

▼ Sunlight/Temperature Sensor

The air-conditioning system measures inside and outside temperatures, humidity and sunlight using the sunlight/temperature sensor. It sets temperatures inside the cabin accordingly.

⚠ CAUTION

Do not obstruct both sensors, otherwise the air-conditioning system will not operate properly.

Sunlight sensor

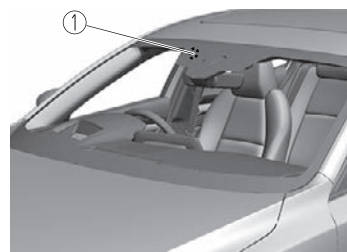

1. Sunlight sensor

Interior Features
Air-Conditioning System

Interior temperature sensor

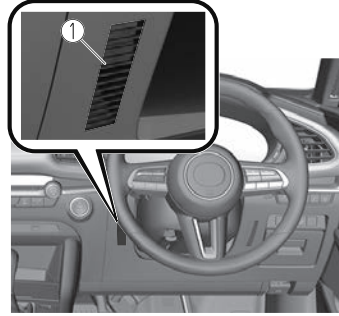

1. Interior temperature sensor

What is MZD Connect ?

▼ What is MZD Connect ?

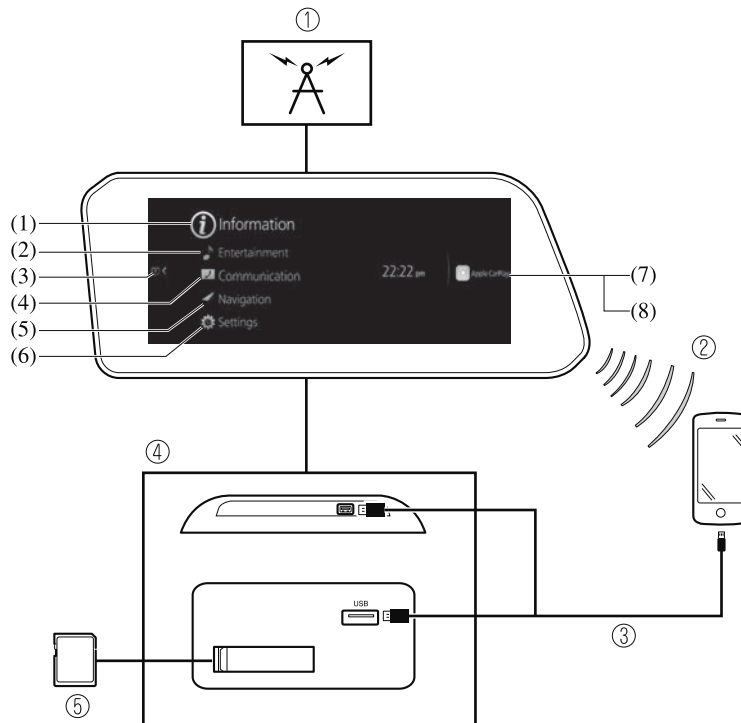

1. Radio
2. Bluetooth® Audio/Hands-Free Call/SMS (Short Message Service)
3. USB Audio/USB Video
4. USB port*1/SD card slot*2
5. SD card (Navigation system)*

*1 The location of the USB slot differs depending on the vehicle model.

*2 The SD card slot is for the navigation system. For vehicles with the navigation system, the SD card (Mazda genuine) with stored map data is inserted into the SD card slot and used.

Interior Features
MZD Connect

No.	Menu	Explanation
(1)	Information	<p>Fuel Efficiency Monitor: Monitor fuel efficiency in real time and view fuel efficiency history.</p> <p>Vehicle Status Monitor: View important vehicle maintenance messages, information, and intervals.</p> <p>Owner's Manual*: Learn about Mazda features, safety information, maintenance, and more.</p>
(2)	Entertainment	<p>FM AM DAB* Bluetooth USB1 Audio/USB2 Audio USB1 Video/USB2 Video</p>
(3)	Notifications	Displays notifications from the vehicle.
(4)	Communication	By connecting your mobile device, such as a Smartphone, to MZD Connect via Bluetooth®, you can use the hands-free call and short message functions.
(5)	Navigation	<p>The navigation system (vehicles with navigation system) can be used when the SD card for the navigation system is inserted.</p> <p>If the SD card for the navigation system is not inserted, the compass indicating the direction in which the vehicle is moving is displayed. The compass may not indicate the correct bearing when the vehicle is stopped or travelling at a slow speed.</p> <p>For the navigation system operation, refer to the navigation system manual.</p>
(6)	Settings	<p>You can change the settings for the MZD Connect screen, sound settings, and the vehicle functions.</p> <p>In-Vehicle Displays: Configures settings and content for all in-vehicle displays.</p> <p>Sound Settings: Configures the in-vehicle listening experience.</p> <p>Safety Settings: Configures safety and driver assistance features.</p> <p>Vehicle Settings: Configures vehicle convenience features.</p> <p>Connectivity Settings: Configures Bluetooth and other device connectivity settings.</p> <p>System Settings: Configures language, time, and other general settings.</p>
(7)	Apple CarPlay	You can use Apple CarPlay by connecting an iPhone compatible with Apple CarPlay to the USB slot.
(8)	Android Auto	You can use Android Auto™ by connecting an Android™ Smartphone compatible with Android Auto™ to the USB slot.

*Some models. **5-15**

MZD Connect

WARNING

Always adjust the audio while the vehicle is stopped:

Do not adjust the audio remote control switch while driving the vehicle. Adjusting the audio while driving the vehicle is dangerous as it could distract your attention from the vehicle operation which could lead to a serious accident.

Even if the audio control switches are equipped on the steering wheel, learn to use the switches without looking down at them so that you can keep your maximum attention on the road while driving the vehicle.

Do not allow the connection plug cord to get tangled with the shift lever (manual transmission)/selector lever (automatic transmission):

Allowing the plug cord to become tangled with the shift lever (manual transmission)/selector lever (automatic transmission) is dangerous as it could interfere with driving, resulting in an accident.

Do not adjust the portable audio unit or a similar product while driving the vehicle:

Adjusting the portable audio unit or a similar product while driving the vehicle is dangerous as it could distract your attention from the vehicle operation which could lead to a serious accident. Always adjust the portable audio unit or a similar product while the vehicle is stopped.

CAUTION

For the purposes of safe driving, adjust the audio volume to a level that allows you to hear sounds outside of the vehicle including car horns and particularly emergency vehicle sirens.

NOTE

- Do not use MZD Connect for a long time with the engine stopped. Otherwise, the battery power could be depleted.*
- If a mobile phone or CB radio is used in or near the vehicle, it could cause noise to occur from the audio system. However, this does not indicate a problem.*

MZD Connect Basic Operations

▼ MZD Connect Basic Operations

NOTE

- The explanation of functions described in this manual may differ from the actual operation, and the shapes of screens and buttons and the letters and characters displayed may also differ from the actual appearance.
- Additionally, depending on future software updates, the content may successively change without notice.
- This manual contains an overview of MZD Connect and its basic operations. For details on each function, refer to the MZD Connect Owner's Manual.

▼ Commander Switch Operation

The commander switch can be used to switch to each function and to operate each function. Set the palm of your hand on the commander knob so that your fingers can touch each of the switches.

You can switch the screens without having to look down at your hand.

NOTE

For safety reasons, some operations are disabled while driving the vehicle.

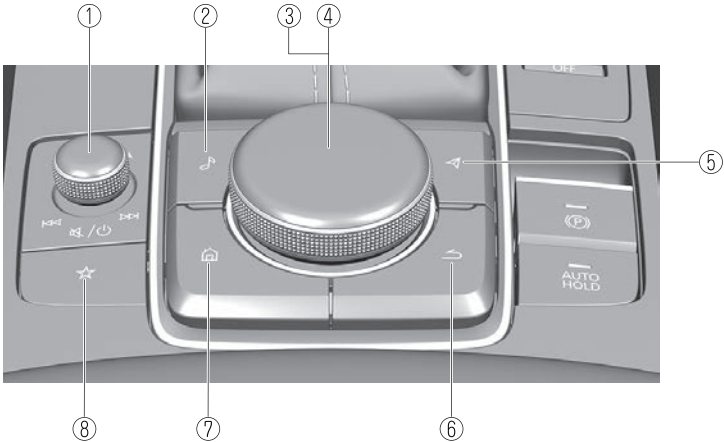







MZD Connect

The shape of the switches varies depending on the vehicle model.

No.	Item	Explanation
1		<p>Volume knob:</p> <p>Volume adjustment Adjust the volume by turning the volume knob. If you adjust the volume during a voice guidance, the volume of the voice guidance changes. If you adjust the volume while making a hands-free call, the conversation volume changes. Press the volume knob to mute the audio. Press the knob again to cancel.</p> <p>Power off Press and hold the volume knob to turn the MZD Connect power off.</p> <p>NOTE <i>If you press the volume knob to mute an audio source which can be paused, such as Apple CarPlay, USB audio, or Bluetooth® audio, while it is playing, the song playback pauses. Press the volume knob again to cancel the mute and the pause at the same time.</i></p> <p>Selecting a radio station (FM/AM radio) You can call up radio stations registered to your favourites by sliding the volume knob left/right while listening to FM/AM radio. The radio stations change each time you slide the volume knob. In addition, press and hold the volume knob until you hear a beep to start automatic station selection. It stops when a radio broadcast is tuned in.</p> <p>(DAB radio)* You can call up radio stations registered to your Favourites by sliding the volume knob left/right while listening to DAB radio. The radio stations change each time you slide the volume knob. In addition, the service switches to the next service when you continue sliding the knob to the right until you hear a beep, and it switches to the previous service when you continue sliding the knob to the left. If there is no next or previous service in the selected Ensemble, Ensemble switches.</p> <p>Cuing Music and video files can be cued by operating the button while audio or video is playing. Slide the volume knob to the right to cue to the beginning of the next song and slide it to the left to cue to the beginning of the previous song. (The order of the songs is in the order of the selected file list.)</p>

Interior Features
MZD Connect

No.	Item	Explanation
2		Entertainment button: The audio source screen last used is displayed. (During Apple CarPlay or Android Auto™ music playback) Displays the Apple CarPlay or Android Auto™ playback screen.
3		Commander knob (selection): Rotate or slide the commander knob to select the functions you want to use.
4		Commander knob (select): Press the commander knob to select the function you want to use.
5		Map button: Displays the navigation screen (vehicles with navigation system). In order for the navigation system to function, the SD card for the navigation system is required. If the SD card for the navigation system is not inserted, the compass indicating the direction in which the vehicle is moving is displayed. For the navigation system operation, refer to the navigation system manual. (During Apple CarPlay or Android Auto™ route guidance) Displays the Apple CarPlay or Android Auto™ map screen.
6		Back button: Returns to previous screen.
7		Home button: Displays the home screen. (While Apple CarPlay or Android Auto™ is displayed) Displays the Apple CarPlay or Android Auto™ home screen. (While Apple CarPlay or Android Auto™ is connected) Press and hold while the MZD Connect screen is displayed to switch the screens between Apple CarPlay and Android Auto™. In addition, press and hold while the Apple CarPlay or Android Auto™ screen is displayed to switch to the MZD Connect screen.
8		Favourites button: Displays the favourites screen. Press and hold to register contacts, radio stations, or navigation points which are displayed on the screen at that time.

MZD Connect



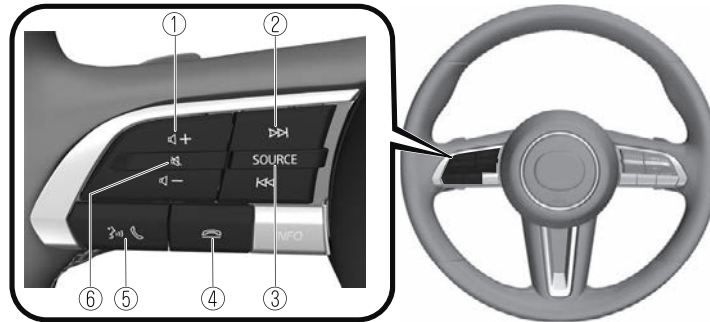

▼ Audio Remote Control Switch Operation

The audio remote control switch is on the left side of the steering wheel. You can operate the audio unit from the steering wheel.



The shape of the switches differs depending on the vehicle model.

No.	Item	Explanation
1		Volume adjustment button: Press the (+) or (-) button to adjust the volume. If you adjust the volume during a voice guidance, the volume of the voice guidance changes. If you adjust the volume while making a hands-free call, the conversation volume changes.

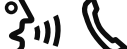
No.	Item	Explanation
2		<p>Seek Switch:</p> <p>Selecting a radio station (FM/AM radio) You can call up radio stations registered to your favourites by pressing the seek switch while listening to FM/AM radio. The radio stations change each time you press the switch. In addition, press and hold the seek switch until you hear a beep to start automatic station selection. It stops when a radio broadcast is tuned in.</p> <p>(DAB radio)* You can call up radio stations registered to your Favourites by pressing the seek switch while listening to DAB radio. The radio station changes each time you press the seek switch. In addition, if you press and hold the seek switch until you hear a beep, the service switches to the next or previous service. If there is no next or previous service in the selected Ensemble, Ensemble switches.</p>
		<p>Cuing Music and video files can be cued by operating the button while audio or video is playing. Press the  to cue to the beginning of the next song and press the  to cue to the beginning of the previous song. (The order of the songs is in the order of the selected file list.)</p>
3	SOURCE	<p>SOURCE button: The audio source can be switched each time the button is pressed. In addition, when the button is pressed and held, the audio currently being played is turned off and the audio source selection screen is displayed.</p> <p>(During Apple CarPlay or Android Auto™ playback) Press and hold the SOURCE button to turn off the audio currently being played.</p>
4		<p>Hang-up button*1 : (During a call) Press the button to end the call.</p> <p>(While receiving a call) Press the button to refuse a call.</p>
5		<p>Talk/Pick-up button*1 : (While receiving a call) Press the button to answer the call.</p>

*Some models. **5-21**

MZD Connect



No.	Item	Explanation
6		<p>Mute button: Press the button to mute. Press it again to cancel the mute.</p> <p>NOTE <i>If you press the mute button to mute an audio source which can be paused, such as Apple CarPlay, USB audio, or Bluetooth® audio, while it is playing, the song playback pauses. Press the mute button again to cancel the mute and the pause at the same time.</i></p>

*1 You can also use the voice recognition for the talk/pick-up button, and hang-up button.
For details, refer to Operation Using Voice Recognition Function (page 5-22).

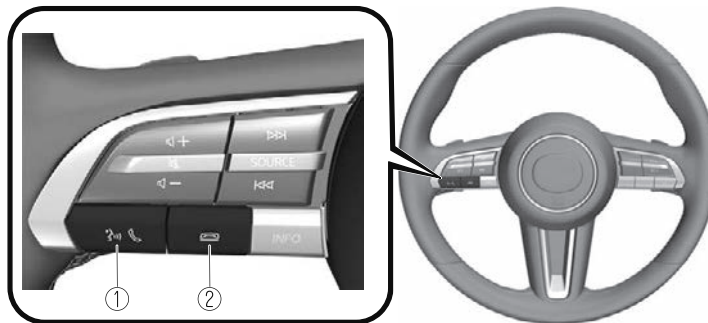
▼ Operation Using Voice Recognition Function



The shape of the switches differs depending on the vehicle model.

No.	Item	Explanation
1		<p>Talk/Pick-up button : When the button is pressed, the voice recognition top screen is displayed and the voice recognition is activated.</p> <p>(While voice guidance is being announced) Press the button to skip the voice guidance.</p>
2		<p>Hang-up button: Press the button to end the voice recognition.</p>

Voice recognition activation

When the talk/pick-up button on the audio remote control switch is pressed, the voice recognition top screen is displayed.

NOTE

While Apple CarPlay or Android Auto™ is connected, Siri or Android Auto™ voice recognition is activated, but MZD Connect voice recognition is not activated.

Commands usable at any time

- “Help” - Can be used to check for usable voice commands.
- “Back” - Returns to the previous screen. When a voice command is spoken while on the telephone number input screen, the content that was previously input is deleted.
- “Cancel” - The voice recognition is ended.

To learn more on how to operate MZD Connect

- “Owner's Manual” - The operation guide screen is displayed.

Ending voice recognition

Do any one of the following operations:

- Press the hang-up button.
- Press and hold the talk/Pick-up button.
- Say the word, “Cancel”.

Convenient operating tips for using the voice recognition function

Examples of effective voice commands in various categories are displayed on the voice recognition top screen.

It would be convenient to know these usable voice commands in advance.

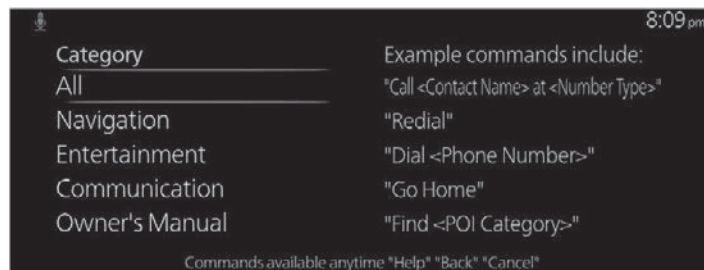

NOTE

- The voice commands indicated in this manual are some examples of usable voice commands. Some voice commands may be unusable depending on the vehicle model.
- When the Barge-In setting is on, voice commands can be made even while the voice guidance is being announced. For details on Barge-In, refer to the Settings section in the MZD Connect Owner's Manual.
- For details on voice commands which can be used on the navigation screen, refer to the navigation system manual.

MZD Connect

To prevent mistaken voice recognition, be aware of the following points:

- When you are using a mobile phone connected via Bluetooth®, the commands relevant to the mobile phone can be used. Connect your mobile phone to Bluetooth® before operating the mobile phone using voice recognition.
- Speaking in a slightly louder voice will improve voice recognition, but an excessively loud voice is unnecessary. Try to speak in a slightly louder voice than when talking to other passengers in the vehicle.
- You do not need to speak slowly. Speak at a normal speed.
- When calling a person in the device's phone book, the recognition rate increases the longer the name is. Errors may occur with names that are short such as “Mama”, “Home”, or “wife”.
- Speak clearly, without pausing between words or numbers.
- Voice commands other than those specified, cannot be recognised. Speak in the wording specified by the voice commands.
- It is not necessary to face the microphone or approach it. Speak the voice commands while maintaining a safe driving position.
- Close the windows and the sunroof to reduce loud noises from outside the vehicle and to prevent the airflow of the air-conditioning system from being a disturbance when using Bluetooth® Hands-Free.
- Make sure that the air flow from the air conditioner is not blowing on the microphone.
- When making voice commands during a voice guidance, speak in a slightly louder voice. But, an excessively loud voice is unnecessary.
- If the voice recognition is poor with the guidance volume set to high, set the Barge-In to OFF.

Some voice command examples corresponding to the voice recognition function

The specified name and number are put into the {}.

Common

- Back
- Help (You can listen to help guidance at each screen.)
- {Line Number} (You can select the line number on the screen.)
- Next Page
- Previous Page
- Cancel

Menu

- All
- Navigation
- Entertainment
- Communication

5-24

- Owner's Manual (the In-vehicle Digital Owner's Manual voice recognition can be displayed.)

Setting

- Voice Recognition Settings
- Owner's Manual (the In-vehicle Digital Owner's Manual voice recognition can be displayed.)
- Display Off

Music

- Play Artist (You can also use “Play Artist {Artist name}”.)
- Play Album (You can also use “Play Album {Album Name}”.)
- Play Playlist (You can also use “Play Playlist {Playlist Name}”.)
- Play Song (You can also use “Play Song {Song Name}”.)
- Play Audiobook (You can also use “Play Audiobook {Audiobook Name}”.)
- Play Podcast (You can also use “Play Podcast {Podcast Name}”.)

Radio

- Tune to {Frequency} AM
- Tune to {Frequency} FM
- Tune to DAB {DAB Station Name}

Source

- Change Source (You can also use “Change Source to USB”^{*1} and “USB”^{*1}.)
- Audio OFF (You can also use “Change Source to Audio OFF”.)

Phone

- Dial Phone Number (You can also use “Dial {Phone Number}”.)
- Call History
- Call a Contact (You can also use “Call {Contact Name}” and “Call {Contact Name} at {Number Type}”.)
- Redial

*1 : Audio source names other than “USB” can also be used as follows:
Bluetooth/AM/FM/DAB/USB1 Audio/USB2 Audio/USB1 Video/USB2 Video

NOTE

- *Some commands may not be usable depending on the region and equipment.*
- *Some commands cannot be used depending on the device connection conditions and the use conditions.*

MZD Connect

▼ Appendix

Gracenote® Database

When connecting a USB audio device to this unit and playing audio, the unit searches the database stored in the vehicle for the album art. If there is a match in the vehicle's database compilation to the music being played, the album art is displayed. The database information stored in this device uses database information in the Gracenote® music recognitions service.

Apple CarPlay



➤ *YOU EXPRESSLY ACKNOWLEDGE AND AGREE THAT USE OF APPLE CARPLAY ("THE APPLICATION") IS AT YOUR SOLE RISK AND THAT THE ENTIRE RISK AS TO SATISFACTORY QUALITY, PERFORMANCE, ACCURACY AND EFFORT IS WITH YOU TO THE MAXIMUM EXTENT PERMITTED BY APPLICABLE LAW, AND THAT THE APPLICATION AND INFORMATION ON THE APPLICATION IS PROVIDED "AS IS" AND "AS AVAILABLE", WITH ALL FAULTS AND WITHOUT WARRANTY OF ANY KIND, AND MAZDA HEREBY DISCLAIMS ALL WARRANTIES AND CONDITIONS WITH RESPECT TO THE APPLICATION AND INFORMATION ON THE APPLICATION, EITHER EXPRESS, IMPLIED OR STATUTORY, INCLUDING, BUT NOT LIMITED TO, THE IMPLIED WARRANTIES AND/OR CONDITIONS OF MERCHANTABILITY, SATISFACTORY QUALITY, FITNESS FOR A PARTICULAR PURPOSE, ACCURACY, QUIET ENJOYMENT, AND NONINFRINGEMENT OF THIRD PARTY RIGHTS.*

AS EXAMPLES, AND WITHOUT LIMITATION, MAZDA DISCLAIMS ANY WARRANTY REGARDING THE ACCURACY OF DATA PROVIDED BY THE APPLICATION, SUCH AS THE ACCURACY OF DIRECTIONS, ESTIMATED TRAVEL TIME, SPEED LIMITS, ROAD CONDITIONS, NEWS, WEATHER, TRAFFIC, OR OTHER CONTENT PROVIDED BY APPLE, ITS AFFILIATES, OR THIRD PARTY PROVIDERS; MAZDA DOES NOT GUARANTEE AGAINST LOSS OF APPLICATION DATA, WHICH MAY BE LOST AT ANY TIME; MAZDA DOES NOT GUARANTEE THAT THE APPLICATION OR ANY SERVICES PROVIDED THROUGH THEM WILL BE PROVIDED AT ALL TIMES OR THAT ANY OR ALL SERVICES WILL BE AVAILABLE AT ANY PARTICULAR TIME OR LOCATION. FOR EXAMPLE, SERVICES MAY BE SUSPENDED OR INTERRUPTED WITHOUT NOTICE FOR REPAIR, MAINTENANCE, SECURITY FIXES, UPDATES, ETC., SERVICES MAY BE UNAVAILABLE IN YOUR AREA OR LOCATION, ETC.

IN ADDITION, YOU UNDERSTAND THAT CHANGES IN THIRD PARTY TECHNOLOGY OR GOVERNMENT REGULATION MAY RENDER THE SERVICES AND/OR APPLICATIONS OBSOLETE AND/OR UNUSABLE. TO THE EXTENT NOT PROHIBITED BY LAW, IN NO EVENT SHALL MAZDA OR ITS AFFILIATES BE LIABLE FOR PERSONAL INJURY, OR ANY INCIDENTAL, SPECIAL, INDIRECT OR CONSEQUENTIAL DAMAGES WHATSOEVER, INCLUDING, WITHOUT LIMITATION, DAMAGES FOR LOSS OF PROFITS, CORRUPTION OR LOSS OF DATA, FAILURE TO TRANSMIT OR RECEIVE ANY DATA, BUSINESS INTERRUPTION OR ANY OTHER COMMERCIAL DAMAGES OR LOSSES, ARISING OUT OF OR RELATED TO THE APPLICATION OR YOUR USE OF OR INABILITY TO USE THE APPLICATION OR INFORMATION ON THE APPLICATION.

- When using Apple CarPlay, please avoid distraction and use Apple CarPlay responsibly. Stay fully aware of driving conditions and always obey applicable laws.

NOTE

- Apple CarPlay is provided by Apple and its use is subject to your agreement to the Apple CarPlay terms of use, which are included as part of the Apple iOS terms of use.
- When using Apple CarPlay, location, speed, and other vehicle data is transferred to your iPhone. For further details, refer to Apple's Privacy Policy.

Android Auto™

- YOU EXPRESSLY ACKNOWLEDGE AND AGREE THAT USE OF ANDROID AUTO™ ("THE APPLICATION") IS AT YOUR SOLE RISK AND THAT THE ENTIRE RISK AS TO SATISFACTORY QUALITY, PERFORMANCE, ACCURACY AND EFFORT IS WITH YOU TO THE MAXIMUM EXTENT PERMITTED BY APPLICABLE LAW, AND THAT THE APPLICATION AND INFORMATION ON THE APPLICATION IS PROVIDED "AS IS" AND "AS AVAILABLE," WITH ALL FAULTS AND WITHOUT WARRANTY OF ANY KIND, AND MAZDA HEREBY DISCLAIMS ALL WARRANTIES AND CONDITIONS WITH RESPECT TO THE APPLICATION AND INFORMATION ON THE APPLICATION, EITHER EXPRESS, IMPLIED OR STATUTORY, INCLUDING, BUT NOT LIMITED TO, THE IMPLIED WARRANTIES AND/OR CONDITIONS OF MERCHANTABILITY, SATISFACTORY QUALITY, FITNESS FOR A PARTICULAR PURPOSE, ACCURACY, QUIET ENJOYMENT, AND NONINFRINGEMENT OF THIRD PARTY RIGHTS.

MZD Connect

AS EXAMPLES, AND WITHOUT LIMITATION, MAZDA DISCLAIMS ANY WARRANTY REGARDING THE ACCURACY OF DATA PROVIDED BY THE APPLICATION, SUCH AS THE ACCURACY OF DIRECTIONS, ESTIMATED TRAVEL TIME, SPEED LIMITS, ROAD CONDITIONS, NEWS, WEATHER, TRAFFIC, OR OTHER CONTENT PROVIDED BY GOOGLE, ITS AFFILIATES, OR THIRD PARTY PROVIDERS; MAZDA DOES NOT GUARANTEE AGAINST LOSS OF APPLICATION DATA, WHICH MAY BE LOST AT ANY TIME; MAZDA DOES NOT GUARANTEE THAT THE APPLICATION OR ANY SERVICES PROVIDED THROUGH THEM WILL BE PROVIDED AT ALL TIMES OR THAT ANY OR ALL SERVICES WILL BE AVAILABLE AT ANY PARTICULAR TIME OR LOCATION. FOR EXAMPLE, SERVICES MAY BE SUSPENDED OR INTERRUPTED WITHOUT NOTICE FOR REPAIR, MAINTENANCE, SECURITY FIXES, UPDATES, ETC., SERVICES MAY BE UNAVAILABLE IN YOUR AREA OR LOCATION, ETC.

IN ADDITION, YOU UNDERSTAND THAT CHANGES IN THIRD PARTY TECHNOLOGY OR GOVERNMENT REGULATION MAY RENDER THE SERVICES AND/OR APPLICATIONS OBSOLETE AND/OR UNUSABLE. TO THE EXTENT NOT PROHIBITED BY LAW, IN NO EVENT SHALL MAZDA OR ITS AFFILIATES BE LIABLE FOR PERSONAL INJURY, OR ANY INCIDENTAL, SPECIAL, INDIRECT OR CONSEQUENTIAL DAMAGES WHATSOEVER, INCLUDING, WITHOUT LIMITATION, DAMAGES FOR LOSS OF PROFITS, CORRUPTION OR LOSS OF DATA, FAILURE TO TRANSMIT OR RECEIVE ANY DATA, BUSINESS INTERRUPTION OR ANY OTHER COMMERCIAL DAMAGES OR LOSSES, ARISING OUT OF OR RELATED TO THE APPLICATION OR YOUR USE OF OR INABILITY TO USE THE APPLICATION OR INFORMATION ON THE APPLICATION.

- *When using Android Auto™, please avoid distraction and use Android Auto™ responsibly. Stay fully aware of driving conditions and always obey applicable laws.*

NOTE

- *Android Auto™ is provided by Google and its use is subject to your agreement to the Android Auto™ terms of use.*
- *When using Android Auto™, location, speed, and other vehicle data is transferred to your smart phone. For further details, refer to Google Privacy Policy.*

Trademark

- iPhone, Siri and Apple Music are trademarks of Apple Inc., registered in the U.S. and other countries.
- Apple CarPlay is trademarks of Apple Inc.
- iOS is a trademark or registered trademark of Cisco in the U.S. and other countries and is used under license.
- “Made for iPhone” and “Made for iPod” mean that an accessory has been designed to connect specifically to iPhone or iPod, and has been certified by the developer to meet Apple performance standards. Apple is not responsible for the operation of this device or its compliance with safety and regulatory standards.

Please note that the use of this accessory with iPhone or iPod may affect wireless performance.

Made for
iPhone 7 Plus
iPhone 7
iPhone SE
iPhone 6s Plus
iPhone 6s
iPhone 6 Plus
iPhone 6
iPhone 5s
iPhone 5c
iPhone 5
iPhone 4s
iPod touch (6th generation)
iPod touch (5th generation)
iPod nano (7th generation)



- Google, Android, Android Auto and other related marks are trademarks of Google LLC.
- AudioPilot® is a registered trademark of Bose Corporation.
- Centerpoint® is a registered trademark of Bose Corporation.
- Windows Media and Microsoft are registered trademarks of Microsoft Corporation U.S. in the United States and other countries.

This product is protected by certain intellectual property rights of Microsoft Corporation and third parties.

Use or distribution of such technology outside of this product is prohibited without a license from Microsoft or an authorised Microsoft subsidiary and third parties.

- The Bluetooth® word mark and logos are registered trademarks owned by Bluetooth SIG, Inc. and any use of such marks by Panasonic Corporation is under license. Other trademarks and trade names are those of their respective owners.



Interior Features

MZD Connect

- SDHC Logo is a trademark of SD-3C, LLC.



- Gracenote, the Gracenote logo and logotype are either a registered trademark or a trademark of Gracenote, Inc. in the United States and/or other countries.



Regarding the license for the audio amplifier (except vehicles with BOSE® audio)

License for CMSIS-RTOS RTX Implementation

Copyright (c) 1999-2009 KEIL, 2009-2015 ARM Germany GmbH, 2013-2016 ARM Ltd
All rights reserved.

Redistribution and use in source and binary forms, with or without modification, are permitted provided that the following conditions are met:

- Redistributions of source code must retain the above copyright notice, this list of conditions and the following disclaimer
- Redistributions in binary form must reproduce the above copyright notice, this list of conditions and the following disclaimer in the documentation and/or other materials provided with the distribution.
- Neither the name of ARM nor the names of its contributors may be used to endorse or promote products derived from this software without specific prior written permission.

THIS SOFTWARE IS PROVIDED BY THE COPYRIGHT HOLDERS AND CONTRIBUTORS “AS IS” AND ANY EXPRESS OR IMPLIED WARRANTIES, INCLUDING, BUT NOT LIMITED TO, THE IMPLIED WARRANTIES OF MERCHANTABILITY AND FITNESS FOR A PARTICULAR PURPOSE ARE DISCLAIMED.

IN NO EVENT SHALL COPYRIGHT HOLDERS AND CONTRIBUTORS BE LIABLE FOR ANY DIRECT, INDIRECT, INCIDENTAL, SPECIAL, EXEMPLARY, OR CONSEQUENTIAL DAMAGES (INCLUDING, BUT NOT LIMITED TO, PROCUREMENT OF SUBSTITUTE GOODS OR SERVICES; LOSS OF USE, DATA, OR PROFITS; OR BUSINESS INTERRUPTION) HOWEVER CAUSED AND ON ANY THEORY OF LIABILITY, WHETHER IN CONTRACT, STRICT LIABILITY, OR TORT (INCLUDING NEGLIGENCE OR OTHERWISE) ARISING IN ANY WAY OUT OF THE USE OF THIS SOFTWARE, EVEN IF ADVISED OF THE POSSIBILITY OF SUCH DAMAGE.

Interior Equipment

Sunvisors

▼ Sunvisors

When you need a sunvisor, lower it for use in front or swing it to the side.

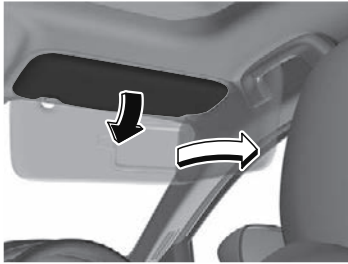

▼ Vanity Mirrors

To use the vanity mirror, lower the sunvisor.

If your vehicle is equipped with a vanity mirror light, it will illuminate when you open the cover.

To prevent the battery from being discharged, the vanity mirror will only illuminate in the tilt range shown in the figure.

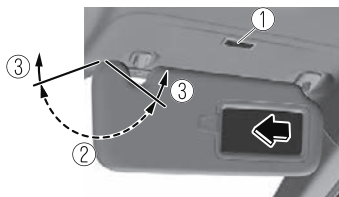

1. Vanity mirror light
2. On
3. Off

NOTE

If a vanity mirror light is left on with the ignition switched OFF, the light is turned off automatically to prevent the battery from being discharged.

The vanity mirror light can be turned on again by doing any of the following operations:

- Opening/closing any door.
- Unlocking any door.
- Switching the ignition to ACC or ON.
- Switching an overhead light/front map light on.

Interior Equipment

Interior Lights

▼ Interior Lights

NOTE

Do not leave the lights on for long periods while the engine is turned off. Otherwise the battery power could be depleted.

Overhead lights

Front

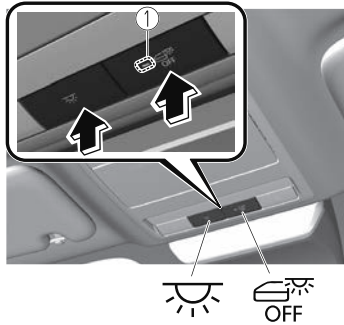

1. Indicator light

Switch	Overhead Lights
 ON/OFF	Press the switch to turn it on. Press the switch again to turn off the lights.

Switch	Overhead Lights
 OFF DOOR OFF	The door interlock can be switched ON/OFF. When the door interlock is OFF, the indicator light in the switch turns on. Door interlock ON (indicator light in switch is off) <ul style="list-style-type: none"> • The lights turn on when any of the doors is opened. • The lights turn on/off in conjunction with the illuminated entry system. Door interlock OFF (indicator light in switch is on) <ul style="list-style-type: none"> • The lights do not turn on even if any of the doors is opened. • The lights do not turn on/off in conjunction with the illuminated entry system.

Rear

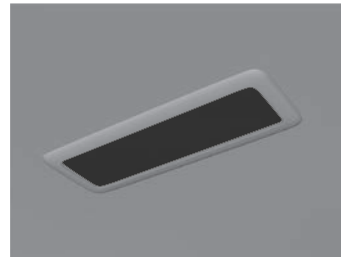

NOTE

The rear overhead light also turn on and off when the front overhead light switch is operated.

Interior Equipment

Front Map lights

Press the switch to illuminate the front map lights, and then press the switch again to turn them off.



NOTE

The front map lights will not turn off even if the switch is pressed in the following cases:

- The overhead lights turn on by operating the overhead light ON/OFF switch (☀️).
- The overhead lights turn on in conjunction with a door opening/closing.
- The illuminated entry system is on.

Rear Map Lights

When the overhead light ON/OFF switch (☀️) is off, press the switch to illuminate the rear map lights, and then press the switch again to turn them off.

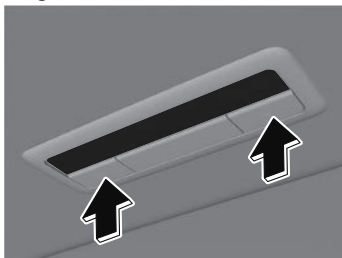

NOTE

- Once the rear map lights have been turned off, they will turn on and off in conjunction with the overhead light operation.
- The rear map lights will not turn off even if the switch is pressed in the following cases:
 - The overhead lights turn on by operating the overhead light ON/OFF switch (☀️).
 - The overhead lights turn on in conjunction with a door opening/closing.
 - The illuminated entry system is on.

Boot light (Saloon)

The boot light is on when the boot is open and off when it is closed.



NOTE

Do not leave the boot open for long periods while the engine is turned off. Otherwise the battery power could be depleted.

Interior Equipment

Luggage compartment light **(Hatchback)**

The luggage compartment light is on when the liftgate is open and off when it is closed.



NOTE

Do not leave the liftgate open for long periods while the engine is turned off. Otherwise the battery power could be depleted.

▼ Illuminated Entry System

The overhead lights turn on when any of the following operations is done with the overhead light switch in the DOOR position.

- The driver's door is unlocked with the ignition is switched OFF.
- The ignition is switched OFF with all doors closed.

NOTE

- *The illumination time differs depending on the operation.*
- *The vehicle is equipped with a battery saver. If an interior light is left on with the ignition switched OFF, the light is turned off automatically after about 15 minutes to prevent battery depletion.*

- *The operation of the illuminated entry system can be changed. Refer to the Settings section in the MZD Connect Owner's Manual.*
- *The illuminated entry system does not operate in conjunction with the overhead lights when the overhead lights are turned on using the overhead light ON/OFF switch.*

Interior Equipment

Accessory Sockets

▼ Accessory Sockets

Only use genuine Mazda accessories or the equivalent requiring no greater than 120 W (DC 12 V, 10 A).

The ignition must be switched to ACC or ON.



⚠ CAUTION

- To prevent accessory socket damage or electrical failure, pay attention to the following:
 - Do not use accessories that require more than 120 W (DC 12 V, 10 A).
 - Do not use accessories that are not genuine Mazda accessories or the equivalent.
 - Close the cover when the accessory socket is not in use to prevent foreign objects and liquids from getting into the accessory socket.
 - Correctly insert the plug into the accessory socket.
 - Do not insert the cigarette lighter into the accessory socket.

- Noise may occur on the audio playback depending on the device connected to the accessory socket.
- Depending on the device connected to the accessory socket, the vehicle's electrical system may be affected, which could cause the warning light to illuminate. Disconnect the connected device and make sure that the problem is resolved. If the problem is resolved, disconnect the device from the socket and switch the ignition off. If the problem is not resolved, consult an expert repairer, we recommend an Authorised Mazda Repairer.

NOTE

To prevent discharging of the battery, do not use the socket for long periods with the engine off or idling.

Connecting the accessory socket

1. Open the lid.
2. Pass the connection plug cord through the cutout of the console and insert the plug into the accessory socket.

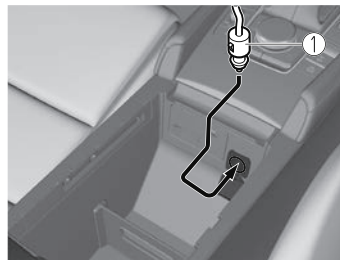

1. Plug

Interior Equipment

Cup Holder

▼ Cup Holder

⚠ WARNING

Never use a cup holder to hold hot liquids while the vehicle is moving:
Using a cup holder to hold hot liquids while the vehicle is moving is dangerous. If the contents spill, you could be scalded.

Do not put anything other than cups or drink cans in cup holders:
Putting objects other than cups or drink cans in a cup holder is dangerous. During sudden braking or manoeuvring, occupants could be hit and injured, or objects could be thrown around the vehicle, causing interference with the driver and the possibility of an accident. Only use a cup holder for cups or drink cans.

▼ Front

Type A

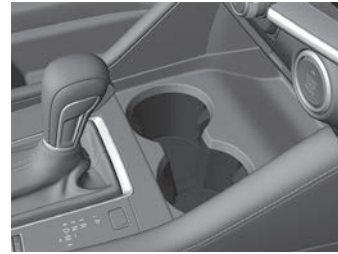

Type B

To use the cup holder, push the release button.

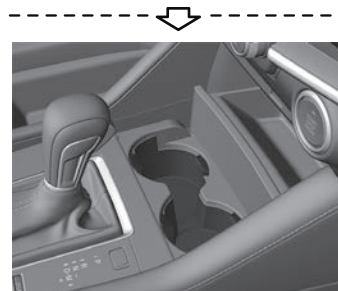
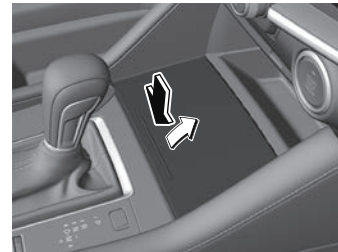

Interior Equipment

▼ Rear*

The rear cup holder is on the rear centre armrest.



Bottle Holder

▼ Bottle Holder

Bottle holders are on the inside of the doors.

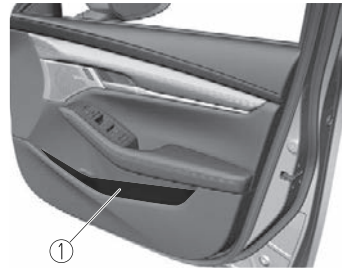

1. Bottle holder

⚠ CAUTION

Do not use the bottle holders for containers without caps. The contents may spill when opening/closing the door or while driving the vehicle.

Interior Equipment

Assist Grips

▼ Assist Grips

⚠ WARNING

Never hang heavy or sharp objects on the assist grips and coat hooks:

Hanging heavy or sharp-ended objects such as a coat hanger from the assist grips or coat hooks is dangerous as they can fly off and hit an occupant in the cabin if a curtain air bag was to deploy, which could result in serious injury or death.

Do not use the assist grips when getting in and out of the vehicle or getting out of a seat:

An assist grip could break under a heavy load resulting in injury.

Use the assist grips to support your body while seated in the vehicle and while the vehicle is moving.



Rear Coat Hooks

▼ Rear Coat Hooks

⚠ WARNING

Never hang heavy or sharp objects on the assist grips and coat hooks:

Hanging heavy or sharp-ended objects such as a coat hanger from the assist grips or coat hooks is dangerous as they can fly off and hit an occupant in the cabin if a curtain air bag was to deploy, which could result in serious injury or death.

Always hang clothes on the coat hooks and the assist grips without hangers.



Interior Equipment

Storage Compartments

▼ Storage Compartments

WARNING

Keep storage boxes closed when driving:
Driving with the storage boxes open is dangerous. To reduce the possibility of injury in an accident or a sudden stop, keep the storage boxes closed when driving.

Do not put articles in storage spaces with no lid:
Putting articles in storage spaces with no lid is dangerous as they could be thrown around the cabin during sudden braking, manoeuvring, or acceleration and cause an accident depending on how the article is stored.

CAUTION

Do not leave lighters or eyeglasses in the storage boxes while parked under the sun. A lighter could explode or the plastic material in eyeglasses could deform and crack from high temperature.

▼ Overhead Console*

This console box is designed to store eyeglasses or other accessories.
Push and release to open.

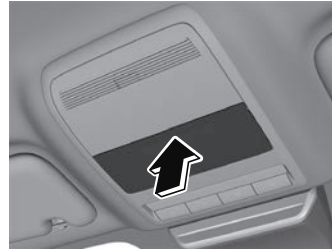

▼ Storage Pocket

To use, open the lid.



▼ Glove Compartment

To open the glove compartment, pull the knob toward you.



To close the glove compartment, firmly press in the centre of the glove compartment lid.

Interior Equipment

▼ Centre Console

To slide the console lid, pull the knob and slide it rearward.

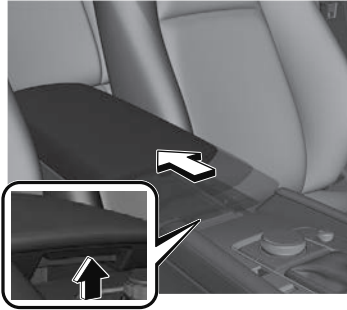

To open the lid, pull the knob, slide the lid rearward, and then lift up the lid.

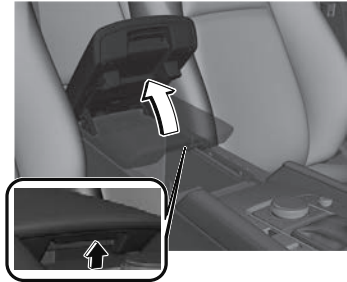

NOTE

The lid can be opened/closed while it is slid to the 1st and 2nd stages, but if the rear seatback is folded, the lid cannot be opened/closed while it is slid to the 2nd stage because the rear seat (head restraint) will contact it.

Centre console divider



Small items can be placed using the centre console divider.

▼ Luggage Compartment

NOTE

Loading golf bags (Saloon)

(Some golf bags may not fit using the following methods depending on their sizes.)

Up to two golf bags can be carried in the boot.

First golf bag: Place the golf bag in the luggage compartment with its bottom pointed to the left and fit it into the front of the compartment.

Interior Features

Interior Equipment

Second golf bag: Place the golf bag in the luggage compartment with its bottom pointed to the left and fit it into the back of the compartment.

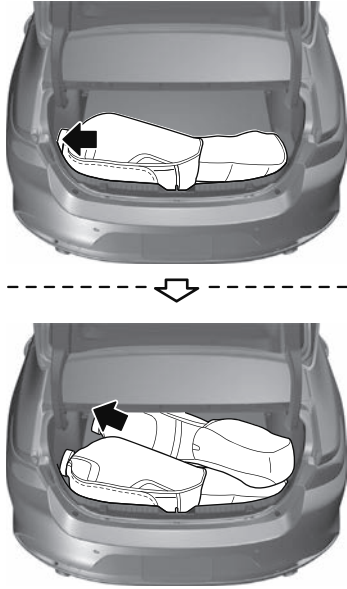

· The arrows indicate the bottoms of the golf bags.

6 Maintenance and Care

How to keep your Mazda in top condition.

Essential Information.....	6-2	Appearance Care.....	6-43
Introduction.....	6-2	Exterior Care.....	6-43
Scheduled Maintenance.....	6-3	Interior Care.....	6-49
Scheduled Maintenance.....	6-3		
Owner Maintenance.....	6-8		
Owner Maintenance			
Precautions.....	6-8		
Bonnet.....	6-9		
Engine Compartment			
Overview.....	6-11		
Engine Oil.....	6-12		
Engine Coolant.....	6-15		
Brake/Clutch Fluid.....	6-16		
Window Washer Fluid.....	6-17		
Body Lubrication.....	6-17		
Wiper Blades.....	6-18		
Battery.....	6-23		
Key Battery Replacement.....	6-25		
Tyres.....	6-28		
Light Bulbs.....	6-31		
Fuses.....	6-34		
Emission Control Maintenance			
(Australia).....	6-41		

Essential Information

Introduction

▼ Introduction

Be careful not to hurt yourself when inspecting your vehicle, replacing a tyre, or doing some kind of maintenance such as car washing.

In particular, wear thick work gloves such as cotton gloves when touching areas that are difficult to see while inspecting or working on your vehicle. Doing inspections or procedures with your bare hands could cause injury.

If you are unsure about any procedure this manual describes, we strongly urge you to have a reliable and qualified technician perform the work, we recommend an Authorised Mazda Repairer.

Authorised Mazda technicians and genuine Mazda parts are dedicated to your vehicle. Without this expertise and the parts that have been designed and made especially for your Mazda, inadequate, incomplete, and insufficient servicing may result in problems. This could lead to vehicle damage or an accident and injuries.

For expert advice and quality service, consult an expert repairer, we recommend an Authorised Mazda Repairer.

The owner should retain evidence that proper maintenance has been performed as prescribed.

A claim against a warranty will not qualify if it results from lack of maintenance and not from defective material or authorised workmanship.

The malfunction diagnosis connector is designed exclusively for connecting the specially designed device to perform on-board diagnosis.

Do not connect any devices other than the specially designed malfunction diagnosis devices for servicing. If any device other than the malfunction diagnosis device is connected, it may affect the vehicle's electrical devices or lead to damage such as battery depletion.

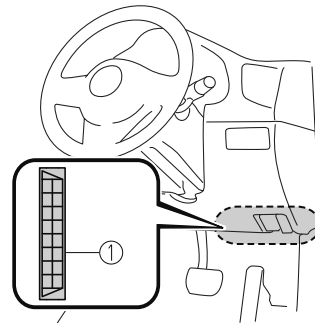

1. Malfunction diagnosis connector

Scheduled Maintenance

▼ Scheduled Maintenance

NOTE

After the prescribed period, continue to follow the described maintenance at the recommended intervals.

Emission control and related systems

The ignition and fuel systems are highly important to the emission control system and to efficient engine operation. Do not tamper with them.

All inspections and adjustments must be made by an expert repairer, we recommend an Authorised Mazda Repairer.

▼ Australia and New Zealand

Australia

Vehicles utilizing the vehicle status monitor feature:

The vehicle status monitor feature alerts you of maintenance needs by turning on the wrench indicator light or displaying a message in the instrument panel, or both.

Every maintenance must be done within 10,000 km, 12 months (after the previous maintenance) or when the display/wrench indication comes on, whichever comes first.

Maintenance item	1st	2nd	3rd	4th	5th	6th	7th	8th	9th	10th	11th	12th	13th	14th	15th	16th
Engine oil & filter*1*2	R	R	R	R	R	R	R	R	R	R	R	R	R	R	R	R
Drive belts*3	I		I		I		I		I		I		I		I	
Engine coolant level	I	I	I	I	I	I	I	I	I	I	I	I	I	I	I	I
Fuel lines and hoses	I		I		I		I		I		I		I		I	
Hoses and tubes for emission	I				I				I				I			
Battery*4*5	I	I	I	I	I	I	I	I	I	I	I	I	I	I	I	I
Brake lines, hoses and connections	I	I	I	I	I	I	I	I	I	I	I	I	I	I	I	I
Brake and clutch fluid level	I	I	I	I	I	I	I	I	I	I	I	I	I	I	I	I
Vacuum brake booster and hose	I	I	I	I	I	I	I	I	I	I	I	I	I	I	I	I
With vacuum booster																
Disc brakes	I	I	I	I	I	I	I	I	I	I	I	I	I	I	I	I
Steering operation and linkages		I		I		I		I		I		I		I		I
Front and rear suspension, ball joints and wheel bearing axial play		I		I		I		I		I		I		I		I
Driveshaft dust boots	I		I		I		I		I		I		I		I	
Exhaust system and heat shields								I								I
Bolts and nuts on chassis and body		T		T		T		T		T		T		T		T

Maintenance and Care

Scheduled Maintenance

Maintenance item	1st	2nd	3rd	4th	5th	6th	7th	8th	9th	10th	11th	12th	13th	14th	15th	16th
Bonnet striker	I	I	I	I	I	I	I	I	I	I	I	I	I	I	I	I
Tyre inflation pressure and tyre wear*6	I	I	I	I	I	I	I	I	I	I	I	I	I	I	I	I
Tyre rotation*7	I	I	I	I	I	I	I	I	I	I	I	I	I	I	I	I
Road test	I	I	I	I	I	I	I	I	I	I	I	I	I	I	I	I
M-MDS check of Vehicle Management and Safety Systems		I		I		I		I		I		I		I		I
Emergency flat tyre repair kit (if installed)*8	I	I	I	I	I	I	I	I	I	I	I	I	I	I	I	I

Additional Scheduled Maintenance items	
Spark plugs	Replace every 120,000 km.
Air filter*9	Replace every 60,000 km or 3 years
Engine coolant*10	Replace at first 200,000 km or 10 years; after that, every 100,000 km or 5 years
Fuel filter	Replace every 150,000 km.
Brake fluid*11	Replace every 40,000 km or 2 years.
Manual transmission oil	Replace every 100,000 km or 5 years.
Cabin air filter (if installed)	Replace every 40,000 km or 2 years

Chart symbols:

I: Inspect: Inspect and clean, repair, adjust, fill up, or replace if necessary.

R: Replace

T: Tighten

Remarks:

- *1 Reset the engine oil data whenever replacing the engine oil regardless of the message/wrench indicator light display.
- *2 If you drive your vehicle under any of the following conditions, replace the engine oil & filter every 5,000 km or 6 months, whichever comes first.
 - a) The vehicle is idled for long periods or driven at low speeds, such as with police cars, taxis, or driver's education school car.
 - b) Driving under dusty conditions.
 - c) Driving for long periods in cold temperatures or driving regularly for short distances only.
 - d) Driving under extremely high temperature conditions.
 - e) Driving continuously in mountainous regions.

Maintenance and Care

Scheduled Maintenance

- *3 Also inspect the air conditioner drive belts, if installed.
If the vehicle is operated primarily under any of the following conditions, inspect the drive belts every 10,000 km or 1 year.
 - a) Driving under dusty conditions.
 - b) The vehicle is idled for long periods or driven at low speeds.
 - c) Driving for long periods in cold temperatures or driving regularly for short distances only.
 - d) Driving under extremely high temperature conditions.
 - e) Driving continuously in mountainous regions.
 - f) Driving for long period in extremely wet or heavy rain condition.
- *4 Inspect the battery electrolyte level, specific gravity and outer appearance. The sealed battery only requires an outer appearance inspection.
- *5 Inspection is only subjected for lead-acid battery.
- *6 Inspect a spare tyre if installed.
- *7 If the vehicle is operated primarily under any of the following conditions, rotate the tyres more often than the recommended intervals.
 - a) Driving on bumpy roads, gravel roads, snowy roads or dirt roads
 - b) Driving uphill and downhill frequently
 - c) Repeated short-distance driving
 - d) On roads having many roundabouts
- *8 Check the tyre repair fluid expiration date every year when performing the periodic maintenance. Replace the tyre repair fluid bottle with new one before the expiration date.
- *9 If the vehicle is operated in very dusty or sandy areas, clean and if necessary, replace the air filter more often than the recommended intervals.
- *10 Use of FL-22 is recommended when replacing engine coolant. Using engine coolant other than FL-22 may cause serious damage to the engine and cooling system.
- *11 If the brakes are used extensively (for example, continuous hard driving or mountain driving) or if the vehicle is operated in extremely humid climates, replace the brake fluid annually.

NOTE

Please ask Mazda Repairer to check Mazda computer network to ensure there are no outstanding campaign or recall actions on the vehicle.

New Zealand

Vehicles utilizing the vehicle status monitor feature:

The vehicle status monitor feature alerts you of maintenance needs by turning on the wrench indicator light or displaying a message in the instrument panel, or both.

Every maintenance must be done within 15,000 km, 12 months (after the previous maintenance) or when the display/wrench indication comes on, whichever comes first.

Maintenance item	1st	2nd	3rd	4th	5th	6th	7th	8th	9th	10th	11th	12th	13th	14th	15th	16th
Engine oil & filter*1*2	R	R	R	R	R	R	R	R	R	R	R	R	R	R	R	R
Spark plugs	Replace every 120,000 km.															
Air filter*3	Replace every 60,000 km or 3 years.															
Drive belts*4	I	I	I	I	I	I	I	I	I	I	I	I	I	I	I	I
Engine coolant level	I	I	I	I	I	I	I	I	I	I	I	I	I	I	I	I

Maintenance and Care

Scheduled Maintenance

Maintenance item	1st	2nd	3rd	4th	5th	6th	7th	8th	9th	10th	11th	12th	13th	14th	15th	16th
Engine coolant*5	Replace at first 200,000 km or 10 years; after that, every 100,000 km or 5 years.															
Fuel filter	Replace every 150,000 km.															
Fuel lines and hoses	I	I	I	I	I	I	I	I	I	I	I	I	I	I	I	I
Hoses and tubes for emission				I				I				I				I
Battery*6*7	I	I	I	I	I	I	I	I	I	I	I	I	I	I	I	I
Brake lines, hoses and connections	I	I	I	I	I	I	I	I	I	I	I	I	I	I	I	I
Vacuum brake booster and hose	With vacuum booster		I	I	I	I	I	I	I	I	I	I	I	I	I	I
Brake and clutch fluid level	I	I	I	I	I	I	I	I	I	I	I	I	I	I	I	I
Brake fluid*8	Replace every 40,000 km or 2 years.															
Disc brakes	I	I	I	I	I	I	I	I	I	I	I	I	I	I	I	I
Manual transmission oil	Replace every 100,000 km or 5 years.															
Steering operation and linkages	I	I	I	I	I	I	I	I	I	I	I	I	I	I	I	I
Front and rear suspension, ball joints and wheel bearing axial play	I	I	I	I	I	I	I	I	I	I	I	I	I	I	I	I
Driveshaft dust boots	I	I	I	I	I	I	I	I	I	I	I	I	I	I	I	I
Tyre inflation pressure and tyre wear*9	I	I	I	I	I	I	I	I	I	I	I	I	I	I	I	I
Tyre rotation*10	I	I	I	I	I	I	I	I	I	I	I	I	I	I	I	I
Exhaust system and heat shields	Inspect every 80,000 km.															
Bolts and nuts on chassis and body	T	T	T	T	T	T	T	T	T	T	T	T	T	T	T	T
Cabin air filter (if installed)	Replace every 40,000 km or 2 years.															
Road test	I	I	I	I	I	I	I	I	I	I	I	I	I	I	I	I
M-MDS check of Vehicle Management and Safety Systems	I	I	I	I	I	I	I	I	I	I	I	I	I	I	I	I
Emergency flat tyre repair kit (if installed)*11	Inspect annually.															

Chart symbols:

I: Inspect and clean, repair, adjust, fill up, or replace if necessary.

R: Replace

T: Tighten

Remarks:

*1 Reset the engine oil data whenever replacing the engine oil regardless of the message/wrench indicator light display.

*2 If you drive your vehicle under any of the following conditions, replace the engine oil & filter every 7,500 km or 6 months, whichever comes first.

- a) The vehicle is idled for long periods or driven at low speeds, such as with police cars, taxis, or driver's education school car.

Maintenance and Care
Scheduled Maintenance

- b) Driving under dusty conditions.
 - c) Driving for long periods in cold temperatures or driving regularly for short distances only.
 - d) Driving under extremely high temperature conditions.
 - e) Driving continuously in mountainous regions.
- *3 If the vehicle is operated in very dusty or sandy areas, clean and if necessary, replace the air filter more often than the recommended intervals.
- *4 Also inspect the air conditioner drive belts, if installed.
If the vehicle is operated primarily under any of the following conditions, inspect the drive belts every 7,500 km or 6 months.
- a) Driving under dusty conditions.
 - b) The vehicle is idled for long periods or driven at low speeds.
 - c) Driving for long periods in cold temperatures or driving regularly for short distances only.
 - d) Driving under extremely high temperature conditions.
 - e) Driving continuously in mountainous regions.
 - f) Driving for long period in extremely wet or heavy rain condition.
- *5 Use of FL-22 is recommended when replacing engine coolant. Using engine coolant other than FL-22 may cause serious damage to the engine and cooling system.
- *6 Inspect the battery electrolyte level, specific gravity and outer appearance. The sealed battery only requires an outer appearance inspection.
- *7 Inspection is only subjected for lead-acid battery.
- *8 If the brakes are used extensively (for example, continuous hard driving or mountain driving) or if the vehicle is operated in extremely humid climates, replace the brake fluid annually.
- *9 Inspect a spare tyre if installed.
- *10 If the vehicle is operated primarily under any of the following conditions, rotate the tyres more often than the recommended intervals.
- a) Driving on bumpy roads, gravel roads, snowy roads or dirt roads
 - b) Driving uphill and downhill frequently
 - c) Repeated short-distance driving
 - d) On roads having many roundabouts
- *11 Check the tyre repair fluid expiration date every year when performing the periodic maintenance. Replace the tyre repair fluid bottle with new one before the expiration date.

NOTE

Please ask Mazda Repairer to check Mazda computer network to ensure there are no outstanding campaign or recall actions on the vehicle.

Owner Maintenance

Owner Maintenance Precautions

▼ Owner Maintenance Precautions

Routine Service

We highly recommend that these items be inspected daily, or at least every week.

- Engine Oil Level (page 6-14)
- Engine Coolant Level (page 6-15)
- Brake and clutch Fluid Level (page 6-16)
- Washer Fluid Level (page 6-17)
- Battery Maintenance (page 6-24)
- Tyre Inflation Pressure (page 6-28)

Improper or incomplete service may result in problems. This section gives instructions only for items that are easy to perform.

As explained in the Introduction (page 6-2), several procedures can be done only by a qualified service technician with special tools.

Improper do-it yourself maintenance during the warranty period may affect warranty coverage. For details, read the separate Mazda Warranty statement provided with the vehicle. If you are unsure about any servicing or maintenance procedure, have it done by an expert repairer, we recommend an Authorised Mazda Repairer.

There are strict environmental laws regarding the disposal of waste oil and fluids. Please dispose of your waste properly and with due regard to the environment.

We recommend that you entrust the oil and fluid changes of your vehicle to an Authorised Mazda Repairer.

WARNING

Do not perform maintenance work if you lack sufficient knowledge and experience or the proper tools and equipment to do the work. Have maintenance work done by a qualified technician:

Performing maintenance work on a vehicle is dangerous if not done properly. You can be seriously injured while performing some maintenance procedures.

If you must run the engine while working under the bonnet, make certain that you remove all jewellery (especially rings, bracelets, watches, and necklaces) and all neckties, scarves, and similar loose clothing before getting near the engine or cooling fan which may turn on unexpectedly:

Working under the bonnet with the engine running is dangerous. It becomes even more dangerous when you wear jewellery, loose clothing or have long hair or a long beard.

Either can become entangled in moving parts and result in injury.



Pull over to a safe location, then switch the ignition off and make sure the fan is not running before attempting to work near the cooling fan:

Working near the cooling fan when it is running is dangerous. The fan could continue running indefinitely even if the engine has stopped and the engine compartment temperature is high. You could be hit by the fan and seriously injured.

Do not leave items in the engine compartment:

After you have finished checking or doing servicing in the engine compartment, do not forget and leave items such as tools or rags in the engine compartment. Tools or other items left in the engine compartment could cause engine damage or a fire leading to an unexpected accident.

Bonnet

▼ Bonnet

⚠ WARNING

Always check that the bonnet is closed and securely locked:

A bonnet that is not closed and securely locked is dangerous as it could fly open while the vehicle is moving and block the driver's vision which could result in a serious accident.

▼ Opening the Bonnet

1. With the vehicle parked, pull the release handle to unlock the bonnet.

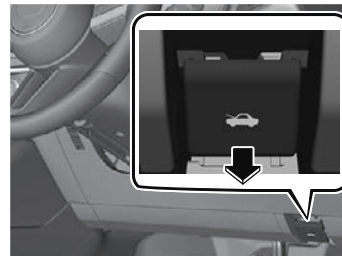

2. Insert your hand into the bonnet opening, slide the latch lever to the left, and lift up the bonnet.

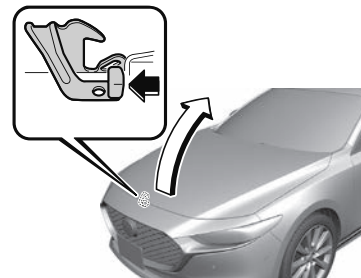

Owner Maintenance

3. Grasp the support rod in the padded area and secure it in the support rod hole indicated by the arrow to hold the bonnet open.

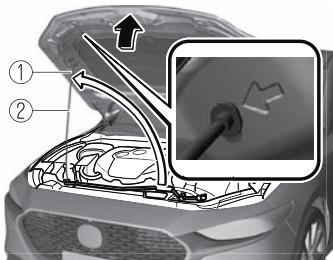

1. Pad
2. Support rod

▼ Closing the Bonnet

1. Check under the bonnet area to make certain all filler caps are in place and all loose items (e.g. tools, oil containers, etc.) have been removed.
2. Lift the bonnet, grasp the padded area on the support rod, and secure the support rod in the clip. Verify that the support rod is secured in the clip before closing the bonnet.

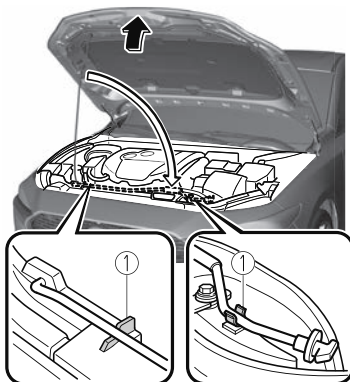

1. Clip

3. Lower the bonnet slowly to a height of about 20 cm (7.9 in) above its closed position and then let it drop.

⚠ CAUTION

When closing the bonnet, do not push it excessively such as by applying your weight. Otherwise, the bonnet could be deformed.

Engine Compartment Overview

▼ Engine Compartment Overview

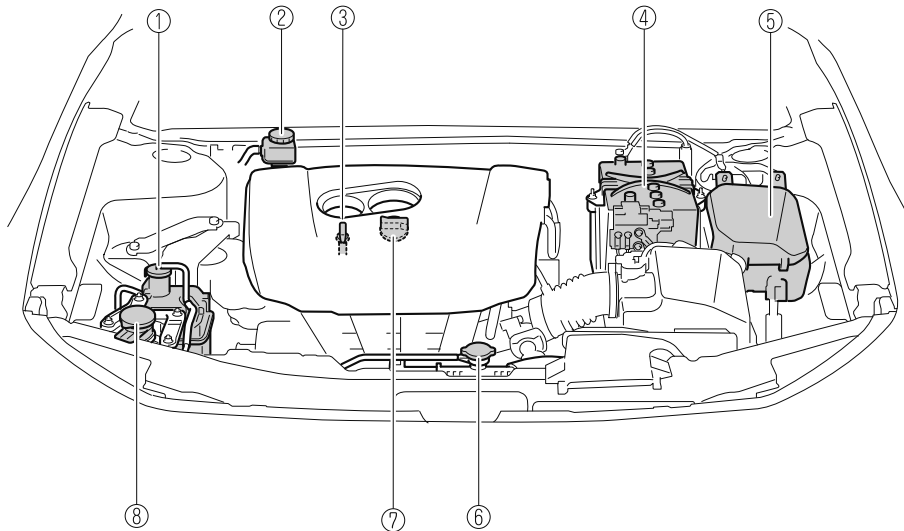

1. Engine coolant reservoir
2. Brake/Clutch fluid reservoir
3. Engine oil dipstick
4. Battery
5. Fuse block
6. Cooling system cap
7. Engine oil-filler cap
8. Windscreen washer fluid reservoir

Owner Maintenance

Engine Oil

▼ Engine Oil

NOTE

Changing the engine oil should be done by an expert repairer, we recommend an Authorised Mazda Repairer.

▼ **Recommended Oil**

In order to keep the maintenance interval (page 6-3) and to protect the engine from damage caused by poor lubrication, it is vitally important to make use of engine oil with the correct specification. Do not use oils which do not meet the following specifications or requirements. Use of unsuitable oil may lead to engine damage which is not covered by the Mazda Warranty.

(Australia)

Temperature Range SAE Viscosity Numbers	
Grade	°C -40 -30 -20 -10 0 10 20 30 40
	°F -40 -20 0 20 40 60 80 100
API SL/SM/SN or ILSAC GF-III/GF-IV/GF-V	10W-30
	5W-20 5W-30
	0W-20 0W-30

(New Zealand)

Temperature Range SAE Viscosity Numbers	
Grade	°C -40 -30 -20 -10 0 10 20 30 40
	°F -40 -20 0 20 40 60 80 100
API SN or higher, or ILSAC GF-V or higher	10W-30
	5W-20 5W-30
	0W-20 0W-30

Engine oil viscosity, or thickness, has an effect on fuel economy and cold-weather operation (starting and oil flow).

Low-viscosity engine oils can provide improved fuel economy and cold-weather performance.

When choosing an oil, consider the temperature range your vehicle will operate in before the next oil change.

Then select the recommended viscosity from the chart.

⚠ CAUTION

➤ *Using oils of viscosity besides those recommended for specific temperature ranges could result in engine damage.*

Owner Maintenance

NOTE

· It is normal for all engines to consume engine oil under normal driving conditions. Engine oil consumption may be as high as 0.8 L/1,000 km (1 L/800 miles). This may be as a result of evaporation, internal ventilation or burning of the lubricating oil in the working engine. Oil consumption may be higher when the engine is new due to the running-in process. Oil consumption is also dependant on engine speed and engine load. Under extreme driving conditions, oil consumption may be higher.

▼ Inspecting Engine Oil Level

1. Be sure the vehicle is on a level surface.
2. Warm up the engine to normal operating temperature.
3. Turn it off and wait at least 5 minutes for the oil to return to the sump.
4. Pull out the dipstick, wipe it clean, and reinsert it fully.

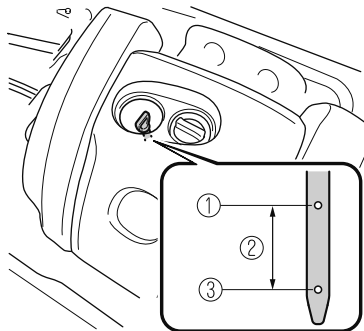

1. MAX
2. OK
3. MIN

5. Pull it out again and examine the level. The level is normal if it is between the MIN and MAX marks. If it is near or below MIN, add enough oil to bring the level to MAX.

⚠ CAUTION

Do not overfill the engine oil. This may cause engine damage.

6. Make sure the O-ring on the dipstick is positioned properly before reinserting the dipstick.
7. Reinsert the dipstick fully.

Engine Coolant

▼ Inspecting Coolant Level

WARNING

Do not use a match or live flame in the engine compartment. DO NOT ADD COOLANT WHEN THE ENGINE IS HOT:

A hot engine is dangerous. If the engine has been running, parts of the engine compartment can become very hot. You could be burned. Carefully inspect the engine coolant in the coolant reservoir, but do not open it.



Pull over to a safe location, then switch the ignition off and make sure the fan is not running before attempting to work near the cooling fan:

Working near the cooling fan when it is running is dangerous. The fan could continue running indefinitely even if the engine has stopped and the engine compartment temperature is high. You could be hit by the fan and seriously injured.



Do not remove either cooling system cap when the engine and radiator are hot:

When the engine and radiator are hot, scalding coolant and steam may shoot out under pressure and cause serious injury.

NOTE

Changing the coolant should be done by an expert repairer; we recommend an Authorised Mazda Repairer.

Inspect the antifreeze protection and coolant level in the coolant reservoir at least once a year—at the beginning of the winter season—and before travelling where temperatures may drop below freezing.

Inspect the condition and connections of all cooling system and heater hoses. Replace any that are swollen or deteriorated.

The coolant should be at full in the radiator and between the FULL and LOW marks on the coolant reservoir when the engine is cool.

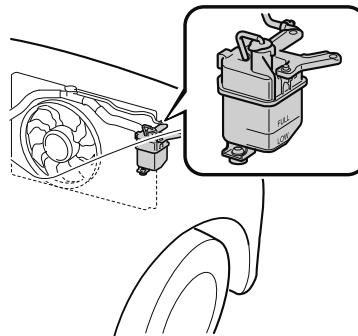

If it is at or near LOW, add enough coolant to the coolant reservoir to provide freezing and corrosion protection and to bring the level to FULL.

Securely tighten the coolant reservoir tank cap after adding coolant.

Owner Maintenance

CAUTION

- Radiator coolant will damage paint. Rinse it off quickly if spilled.
- If the "FL22" mark is shown on or near the cooling system cap, use of FL-22 is recommended when replacing engine coolant. Using engine coolant other than FL-22 may cause serious damage to the engine and cooling system.



FL22 

If the coolant reservoir is empty or new coolant is required frequently, consult an expert repairer, we recommend an Authorised Mazda Repairer.

Brake/Clutch Fluid

▼ Inspecting Brake/Clutch Fluid Level

WARNING

If the brake/clutch fluid level is low, have the brakes inspected:

A low brake/clutch fluid level is dangerous. A low level could indicate brake lining wear or a brake system leak which could cause the brakes to fail and lead to an accident.

The brakes and clutch draw fluid from the same reservoir.

Inspect the fluid level in the reservoir regularly. It should be kept between the MAX and MIN lines.

The level normally drops with accumulated distance, a condition associated with wear of brake and clutch linings. If it is excessively low, have the brake/clutch system inspected by an expert repairer, we recommend an Authorised Mazda Repairer.

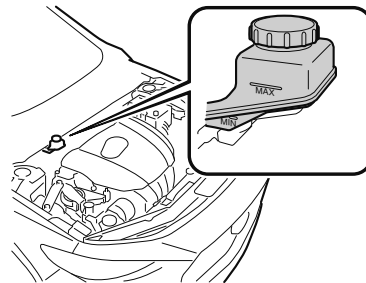

Window Washer Fluid

▼ Inspecting Washer Fluid Level

⚠ WARNING

Use only windscreen washer fluid or plain water in the reservoir:

Using radiator antifreeze as washer fluid is dangerous. If sprayed on the windscreen, it will dirty the windscreen, affect your visibility, and could result in an accident.

Inspect fluid level in the washer fluid reservoir; add fluid if necessary.

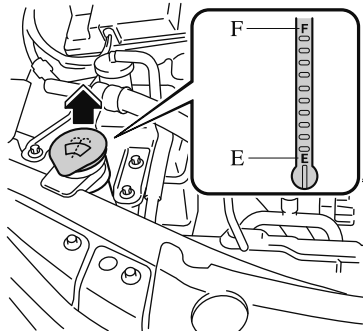

The top of the float should be between F and E.

Use plain water if washer fluid is unavailable.
But use only washer fluid in cold weather to prevent it from freezing.

NOTE

Front and rear washer fluid is supplied from the same reservoir.

Body Lubrication

▼ Body Lubrication

All moving points of the body, such as door and bonnet hinges and locks, should be lubricated each time the engine oil is changed. Use a nonfreezing lubricant on locks during cold weather.

Make sure the bonnet's secondary latch keeps the bonnet from opening when the primary latch is released.

Owner Maintenance

Wiper Blades

▼ Wiper Blades

CAUTION

- *Hot waxes applied by automatic car washers have been known to affect the wiper's ability to clean windows.*
- *To prevent damage to the wiper blades, do not use petrol, paraffin, paint thinner, or other solvents on or near them.*
- *When the wiper lever is in the **AUTO** position and the ignition is switched ON, the wipers may move automatically in the following cases:*
 - *If the windscreen above the rain sensor is touched.*
 - *If the windscreen above the rain sensor is wiped with a cloth.*
 - *If the windscreen is struck with a hand or other object.*
 - *If the rain sensor is struck with a hand or other object from inside the vehicle.*

*Be careful not to pinch hands or fingers as it may cause injury, or damage the wipers. When washing or servicing the vehicle, make sure the wiper lever is in the **OFF** position.*

Contamination of either the windscreen or the blades with foreign matter can reduce wiper effectiveness. Common sources are insects, tree sap, and hot wax treatments used by some commercial car washes.

If the blades are not wiping properly, clean the window and blades with a good cleaner or mild detergent; then rinse thoroughly with clean water. Repeat if necessary.

▼ Replacing Windscreen Wiper Blades

When the wipers no longer clean well, the blades are probably worn or cracked. Replace them.

CAUTION

- *Replace with Mazda genuine wiper blades. If they are replaced with wiper blades other than a Mazda genuine product, they may not wipe with the same efficiency as the genuine product.*
- *To prevent damage to the wiper arms and other components, do not try to sweep the wiper arm by hand.*
- *Do not bend the blade rubber unnecessarily when replacing it. Otherwise, the metal stiffener in the blade may deform and the windscreen wiper operation may be adversely affected.*
- *Do not hold a wiper blade by its end when raising the wiper arm. Otherwise, the part may deform and the wiping performance may lower.*

NOTE

- *You can replace the wiper blades yourself, however you cannot replace the wiper arms.*
- If you want to replace the wiper arms, consult an expert repairer; we recommend an Authorised Mazda Repairer.*

Owner Maintenance

· *Forcefully lowering the wiper arms could damage the wiper arm and blade, and may scratch or crack the windshield.*

1. Move the wipers to the service positions using the following procedure.
 - a) Switch the ignition ON.
 - b) Switch the ignition OFF.
 - c) Press up the wiper switch to the **MIST** position 2 times within 30 seconds after switching the ignition OFF.
When the procedure is completed, the wipers operate and they stop at the service positions.
2. Raise the wiper arms.

CAUTION

To prevent damage to the windshield let the wiper arm down easily, do not let it slap down on the windshield.

3. Slide the blade component in the direction of the arrow while pressing the wiper arm tab to remove the blade component from the wiper arm.

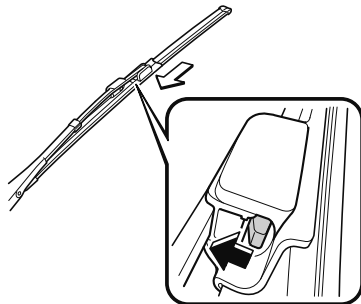

4. Pull the blade rubber in the direction of the arrow and slide it to a position where the blade holder groove can be checked.

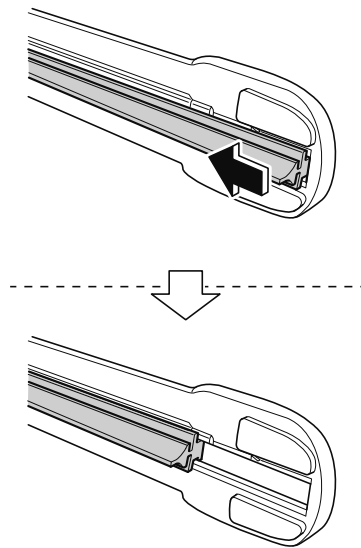

Owner Maintenance

5. Pull the end of the blade rubber from the blade holder groove in the direction of the arrow and remove the blade rubber from the blade holder.

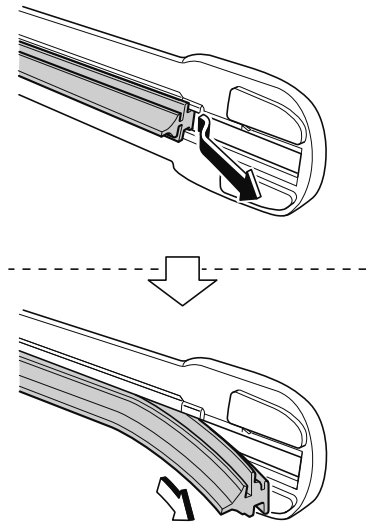

6. Insert the end of the new blade rubber into the groove of the blade holder until it contacts the end of the blade holder.

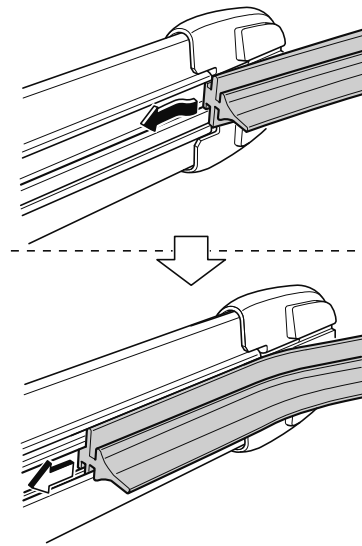

Owner Maintenance

7. After pulling the blade rubber in the direction of the arrow and sliding the blade rubber to a position to check the blade holder groove, slide the blade rubber end in the opposite direction.

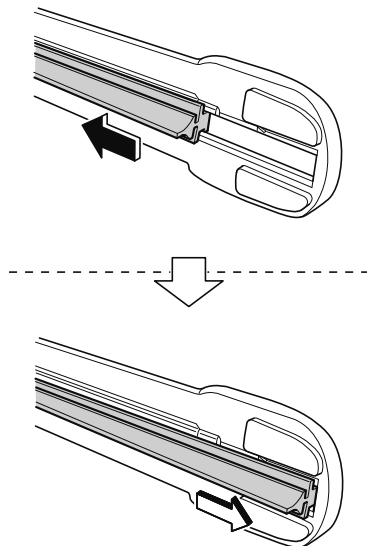

8. Make sure that the blade rubber is correctly installed to the blade holder.
9. Slide the blade component and install it to the wiper arm.

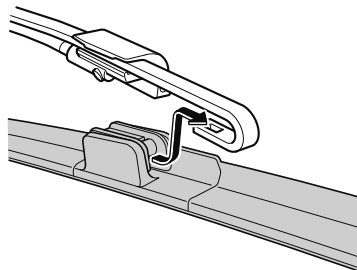

10. Slowly lower the wiper arms onto the windscreen.

11. Move the wipers to their initial positions using the following procedure.
- Make sure that the wipers are set on the windscreen.
 - Switch the ignition ON.
 - Press up the wiper switch to the **MIST** position 1 time.
- When the procedure is completed, the wipers operate and they stop at the initial positions.

▼ Replacing Rear Window Wiper Blade (Hatchback)

When the wiper no longer cleans well, the blade is probably worn or cracked. Replace it.

⚠ CAUTION

To prevent damage to the wiper arm and other components, do not move the wiper by hand.

- Raise the wiper arm and rotate the wiper blade to the right until it unlocks, then remove the blade.

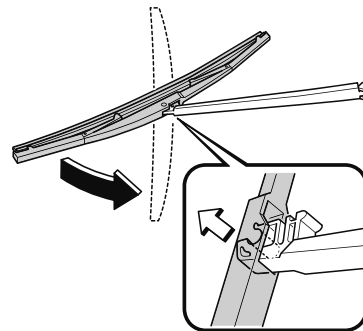

Owner Maintenance

CAUTION

To prevent damage to the rear window, do not let the wiper arm fall on it.

2. Pull down the blade rubber and slide it out of the blade holder.

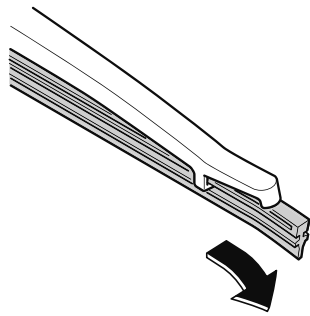

3. Remove the metal stiffeners from the blade rubber and install them in the new blade.

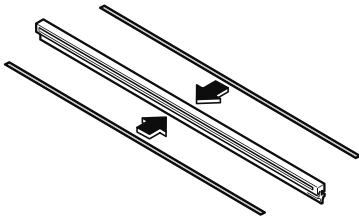

CAUTION

Do not bend or discard the stiffeners. You need to use them again.

4. Carefully insert the new blade rubber. Then install the blade assembly in the reverse order of removal.

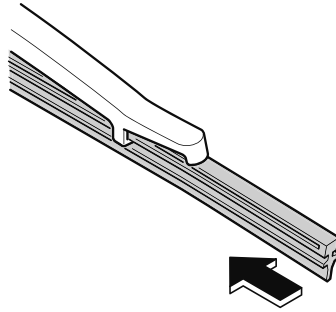

Battery

▼ Battery

WARNING

Read the following precautions carefully before using the battery or inspecting to ensure safe and correct handling:



Always wear eye protection when working near the battery:

Working without eye protection is dangerous. Battery fluid contains SULPHURIC ACID which could cause blindness if splashed into your eyes. Also, hydrogen gas produced during normal battery operation, could ignite and cause the battery to explode.



Wear eye protection and protective gloves to prevent contact with battery fluid:

Spilled battery fluid is dangerous. Battery fluid contains SULPHURIC ACID which could cause serious injuries if it gets in eyes, or on the skin or clothing. If this happens, immediately flush your eyes with water for 15 minutes or wash your skin thoroughly and get medical attention.



Always keep batteries out of the reach of children:

Allowing children to play near batteries is dangerous. Battery fluid could cause serious injuries if it gets in the eyes or on the skin.



Keep flames and sparks away from open battery cells and do not allow metal tools to contact the positive (+) or negative (-) terminal of the battery when working near a battery. Do not allow the positive (+) terminal to contact the vehicle body:

Flames and sparks near open battery cells are dangerous. Hydrogen gas, produced during normal battery operation, could ignite and cause the battery to explode. An exploding battery can cause serious burns and injuries. Keep all flames including cigarettes and sparks away from open battery cells.



Keep all flames and sparks away from open battery cells because hydrogen gas is produced from open battery cells while charging the battery or adding battery fluid:

Flames and sparks near open battery cells are dangerous. Hydrogen gas, produced during normal battery operation, could ignite and cause the battery to explode. An exploding battery can cause serious burns and injuries. Keep all flames including cigarettes and sparks away from open battery cells.

Owner Maintenance

NOTE

Before performing battery maintenance, remove the battery cover.

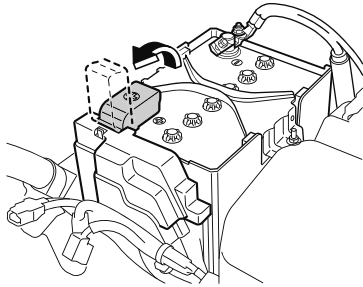

▼ Battery Maintenance

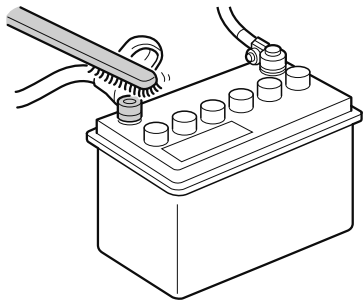

To get the best service from a battery:

- Keep it securely mounted.
- Keep the top clean and dry.
- Keep terminals and connections clean, tight, and coated with petroleum jelly or terminal grease.
- Rinse off spilled electrolyte immediately with a solution of water and baking soda.
- If the vehicle will not be used for an extended time, disconnect the battery leads and charge the battery every 6 weeks.

▼ Inspecting Electrolyte Level

A low level of electrolyte fluid will cause the battery to discharge quickly.

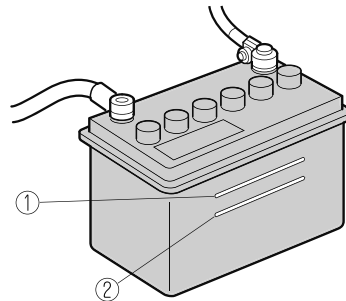

1. Upper level
2. Lower level

Inspect the electrolyte level at least once a week. If it is low, remove the caps and add enough distilled water to bring the level between the upper and lower level (illustration).

Do not overfill.

Examine the specific gravity of the electrolyte with a hydrometer, especially during cold weather. If it is low, recharge the battery.

▼ Battery Recharging

NOTE

- Before performing maintenance or recharging the battery, turn off all accessories and stop the engine.
- To disconnect the battery, remove the negative lead first. Install it last when connecting the battery.
- Be sure to remove the caps before recharging the battery.
- Do not quick-charge the battery.

- If the battery quickly discharges because, for example, the lights were left on too long with the engine off, slow-charge it as required by battery size and charger capacity.
- If the battery gradually discharges because of high electric load while the vehicle is being used, recharge it as required by battery size and charger capacity.

▼ Battery Replacement

Contact an Authorised Mazda Repairer for a battery replacement purchase.

Key Battery Replacement

▼ Key Battery Replacement

If the buttons on the transmitter are inoperable and the operation indicator light does not flash, the battery may be dead.

Replace with a new battery before the transmitter becomes unusable.

CAUTION

- *Make sure the battery is installed correctly. Battery leakage could occur if it is not installed correctly.*
- *When replacing the battery, be careful not to touch any of the internal circuitry and electrical terminals, bend the electrical terminals, or get dirt in the transmitter as the transmitter could be damaged.*
- *There is the danger of explosion if the battery is not correctly replaced.*
- *Dispose of used batteries according to the following instructions.*
 - *Insulate the plus and minus terminals of the battery using cellophane or equivalent tape.*
 - *Never disassemble.*
 - *Never throw the battery into fire or water.*
 - *Never deform or crush.*
- *Replace only with the same type battery (CR2032 or equivalent).*

Owner Maintenance

The following conditions indicate that the battery power is low:

- The KEY warning indication/warning light (red) in the instrument cluster turns on and a message, "Low Key Fob Battery. Replace Battery", is displayed on the multi-information display when the ignition is switched OFF.
- The system does not operate and the operation indicator light on the transmitter does not flash when the buttons are pressed.
- The system's operational range is reduced.

Replacing the battery at an Authorised Mazda Repairer is recommended to prevent damage to the key. If replacing the battery by yourself, follow the instruction.

Replacing the key battery

1. Remove the lower cover while pressing the knob in the direction of the arrow.

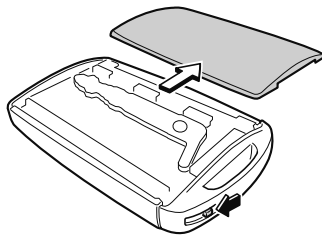

2. Press in the tab to unlock the upper cover.

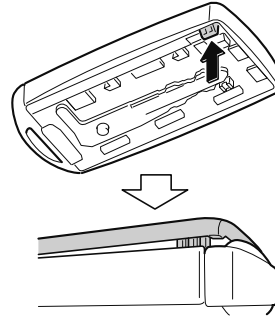

3. Insert a tape-wrapped flathead screwdriver into the gap and slide it in the direction of the arrow.

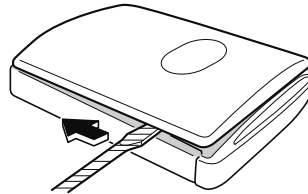

4. Twist the flathead screwdriver in the direction of the arrow and remove the upper cover.

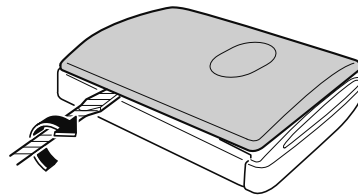

5. Remove the cap using the tape-wrapped flathead screwdriver.

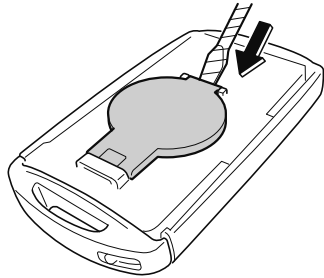

6. Remove the battery using tape-wrapped flathead screwdriver.

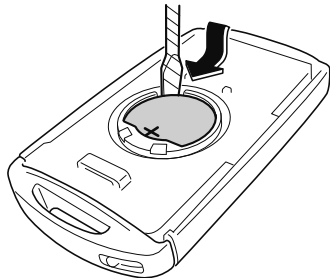

7. Insert a new battery into the transmitter so that the positive pole is facing up.
8. Install the cap.

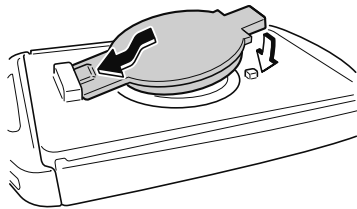

9. Install the upper cover.

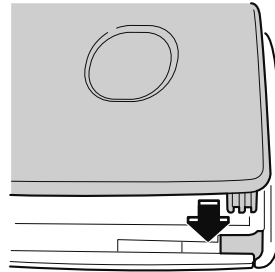

10. Insert the tabs of the lower cover into the slots of the transmitter and install the lower cover.

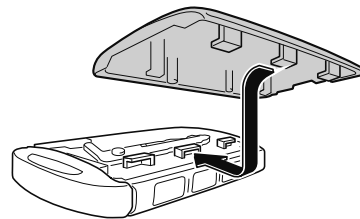

Owner Maintenance

Tyres

▼ Tyres

For reasons of proper performance, safety, and better fuel economy, always maintain recommended tyre inflation pressures and stay within the recommended load limits and weight distribution.

WARNING

Using Different Tyre Types:

Driving your vehicle with different types of tyres is dangerous. It could cause poor handling and poor braking; leading to loss of control.

Except for the limited use of the temporary spare tyre, use only the same type tyres (radial, bias-belted, bias-type) on all four wheels.

Using Wrong-Sized Tyres:

Using any other tyre size than what is specified for the vehicle (page 9-6) is dangerous. It could seriously affect ride, handling, ground clearance, tyre clearance, and speedometer calibration. This could cause you to have an accident. Use only tyres that are the correct size specified for the vehicle.

▼ Tyre Inflation Pressure

WARNING

Always inflate the tyres to the correct pressure:

Overinflation or underinflation of tyres is dangerous. Adverse handling or unexpected tyre failure could result in a serious accident.

Refer to Tyres on page 9-6.

Use only a Mazda-genuine tyre valve cap:

Use of a non-genuine part is dangerous as the correct tyre air pressure cannot be maintained if the tyre valve becomes damaged. If the vehicle is driven under this condition, the tyre air pressure will decrease which could result in a serious accident. Do not use any part for the tyre valve cap that is not a Mazda-genuine part.

Inspect all tyre pressures monthly (including the spare) when the tyres are cold. Maintain recommended pressures for the best ride, handling, and minimum tyre wear.

Refer to the specification charts (page 9-6).

NOTE

- *Always check tyre pressure when tyres are cold.*
- *Warm tyres normally exceed recommended pressures. Do not release air from warm tyres to adjust the pressure.*

Owner Maintenance

- *Underinflation can cause reduced fuel economy, uneven and accelerated tyre wear, and poor sealing of the tyre bead, which will deform the wheel and cause separation of tyre from rim.*
 - *Overinflation can produce a harsh ride, uneven and accelerated tyre wear, and a greater possibility of damage from road hazards.*
- Keep your tyre pressure at the correct levels. If one frequently needs inflating, have it inspected.*

▼ Tyre Rotation

⚠ WARNING

Rotate tyres periodically:

Irregular tyre wear is dangerous. To equalize tread wear for maintaining good performance in handling and braking, rotate the tyres every 10,000 km (6,250 miles), or sooner if irregular wear develops.

During rotation, inspect them for correct balance.

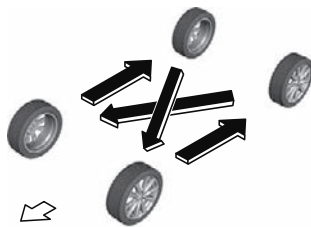

1. Forward

Do not include (TEMPORARY USE ONLY) spare tyre in rotation.

Also, inspect them for uneven wear and damage. Abnormal wear is usually caused by one or a combination of the following:

- Incorrect tyre pressure
- Improper wheel alignment
- Out-of-balance wheel
- Severe braking

After rotation, inflate all tyre pressures to specification (page 9-6) and inspect the wheel nuts for tightness.

⚠ CAUTION

Rotate unidirectional tyres and radial tyres that have an asymmetrical tread pattern or studs only from front to rear, not from side to side. Tyre performance will be reduced if rotated from side to side.

▼ Replacing a Tyre

⚠ WARNING

Always use tyres that are in good condition:

Driving with worn tyres is dangerous. Reduced braking, steering, and traction could result in an accident.

Replace all four tyres at the same time:

Replacing just one tyre is dangerous. It could cause poor handling and poor braking resulting in loss of vehicle control. Mazda strongly recommends that you replace all four tyres at the same time.

Owner Maintenance

If a tyre wears evenly, a wear indicator will appear as a solid band across the tread.

Replace the tyre when this happens.

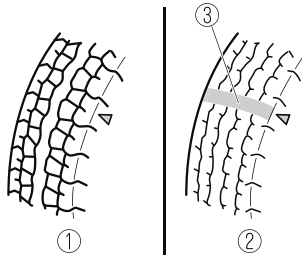

1. New tread
2. Worn tread
3. Tread wear indicator

You should replace the tyre before the band crosses the entire tread.

▼ Temporary Spare Tyre

Inspect the temporary spare tyre at least monthly to make sure it is properly inflated and stored.

NOTE

The temporary spare tyre condition gradually deteriorates even if it has not been used.

The temporary spare tyre is easier to handle because of its construction which is lighter and smaller than a conventional tyre. This tyre should be used only for an emergency and only for a short distance.

Use the temporary spare tyre only until the conventional tyre is repaired, which should be as soon as possible.

Refer to Tyre on page 9-6.

⚠ CAUTION

- Do not use your temporary spare tyre rim with a snow tyre or a conventional tyre. Neither will properly fit and could damage both tyre and rim.
- The temporary spare tyre has a tread life of less than 5,000 km (3,000 miles). The tread life may be shorter depending on driving conditions.
- The temporary spare tyre is for limited use, however, if the tread wear solid-band indicator appears, replace the tyre with the same type of temporary spare (page 6-29).

▼ Replacing a Wheel

⚠ WARNING

Always use wheels of the correct size on your vehicle:

Using a wrong-sized wheel is dangerous. Braking and handling could be affected, leading to loss of control and an accident.

⚠ CAUTION

A wrong-sized wheel may adversely affect:

- Tyre fit
- Wheel and bearing life
- Ground clearance
- Snow-chain clearance
- Speedometer calibration
- Headlight aim
- Bumper height
- Tyre Pressure Monitoring System

NOTE

- When replacing a wheel, make sure the new one is the same as the original factory wheel in diameter, rim width, and offset (inset/outset).
- For details, contact an expert repairer; we recommend an Authorised Mazda Repairer.

Proper tyre balancing provides the best riding comfort and helps reduce tread wear. Out-of-balance tyres can cause vibration and uneven wear, such as cupping and flat spots.

Light Bulbs

▼ Light Bulbs

Front

Type A

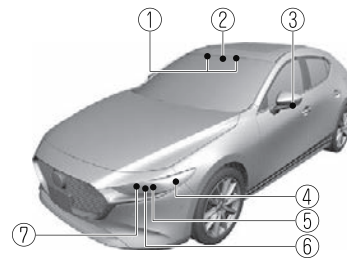

1. Vanity mirror lights*
2. Front overhead lights/Front map lights
3. Side direction indicator lights
4. Running lights/Position lights
5. Headlights (High/Low beam)
6. Headlights (Wide-range low beam)
7. Front direction indicator lights

Type B

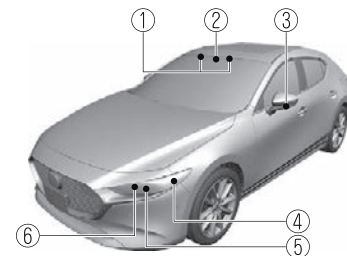

1. Vanity mirror lights*
2. Front overhead lights/Front map lights
3. Side direction indicator lights
4. Position lights
5. Headlights (High/Low beam)
6. Front direction indicator lights

*Some models.

Owner Maintenance

Rear

Saloon

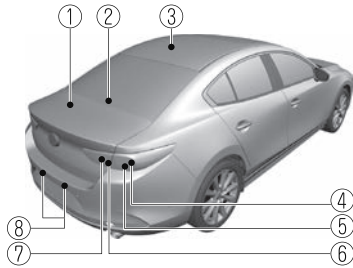

1. Boot light
2. High-mount brake light
3. Rear overhead light
4. Brake lights/Tail lights
5. Rear direction indicator lights
6. Tail lights*
7. Reverse lights
8. Number plate lights

Hatchback

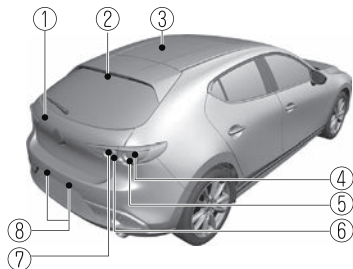

1. Luggage compartment light
2. High-mount brake light
3. Rear overhead light
4. Rear direction indicator lights
5. Brake lights/Tail lights
6. Tail lights*
7. Reverse lights
8. Number plate lights

⚠ CAUTION

When removing the lens or lamp unit using a flathead screwdriver, make sure that the flathead screwdriver does not contact the interior terminal. If the flathead screwdriver contacts the terminal, a short circuit may occur.

NOTE

- When replacing a bulb, contact an expert repairer; we recommend an *Authorised Mazda Repairer* if necessary.
- Use the protective cover and carton for the replacement bulb to dispose of the old bulb promptly and out of the reach of children.
- For details regarding the installation positions of the interior lights, refer to the following:
 - Vanity mirror lights
Refer to *Vanity Mirrors* on page 5-32.
 - Front overhead lights/front map lights, rear overhead light, boot light, and luggage compartment light
Refer to *Interior Lights* on page 5-33.

▼ Replacing Exterior Light Bulbs

The exterior lights have either LEDs or normal bulbs.

Only the bulb for a position lights (type B) can be replaced.

LED type

- Headlights
- Running lights (Type A)
- Front direction indicator lights
- Side direction indicator lights
- High-mount brake light
- Rear direction indicator lights

Owner Maintenance

- Brake lights
- Tail lights
- Reverse lights
- Number plate lights

The LED bulb cannot be replaced as a single unit because it is an integrated unit. The LED bulb has to be replaced with the unit. We recommend an Authorised Mazda Repairer when the replacement is necessary.

Bulb type

Position lights (Type B)

1. Make sure the ignition is switched off, and the headlight switch is off.
2. If you are changing the left bulb, start the engine, turn the steering wheel all the way to the right, and turn off engine. If you are changing the right bulb, turn the steering wheel to the left.
3. Pull the centre of each plastic retainer and remove the retainers.

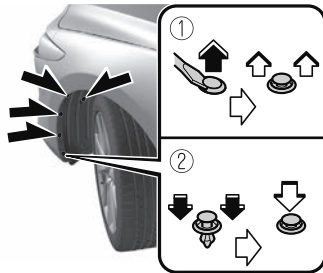

1. Removal
2. Installation

4. Pull the centre of each plastic retainer and remove the retainers.

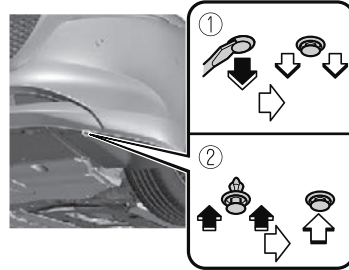

1. Removal
2. Installation
5. Turn the screw anticlockwise and remove it, and then partially peel back the mudguard.

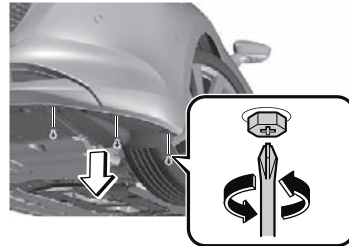

6. Turn the socket and bulb assembly anticlockwise and remove it.

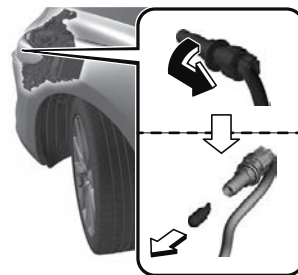

7. Disconnect the bulb from the socket.
8. Install the new bulb in the reverse order of the removal procedure.

Owner Maintenance

▼ Replacing Interior Light Bulbs

LED type

- Front overhead lights/Front map lights
- Rear overhead light
- Vanity mirror lights
- Luggage compartment light (Hatchback)

The LED bulb cannot be replaced as a single unit because it is an integrated unit. The LED bulb has to be replaced with the unit. We recommend an Authorised Mazda Repairer when the replacement is necessary.

Bulb type

Boot light (Saloon)

1. Press both sides of the lens cap to remove it.
2. Disconnect the bulb by pulling it out.

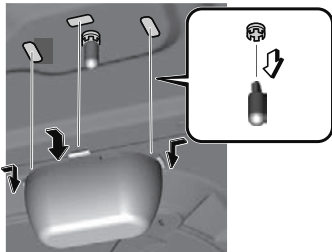

3. Install the new bulb in the reverse order of the removal procedure.

Fuses

▼ Fuses

Your vehicle's electrical system is protected by fuses.

If any lights, accessories, or controls do not work, inspect the appropriate circuit protector. If a fuse has blown, the inside element will be melted.

If the same fuse blows again, avoid using that system and consult an expert repairer, we recommend an Authorised Mazda Repairer as soon as possible.

▼ Fuse Replacement

Replacing the fuses on the vehicle's left side

If the electrical system does not work, first inspect the fuses on the vehicle's left side.

1. Make sure the ignition is switched off, and other switches are off.
2. Open the fuse panel cover.

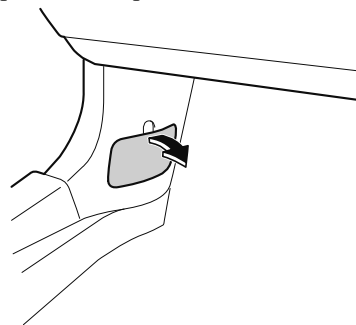

Owner Maintenance

3. Pull the fuse straight out with the fuse puller provided on the fuse block located in the engine compartment.

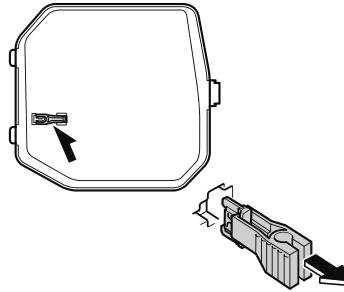

4. Inspect the fuse and replace it if it is blown.

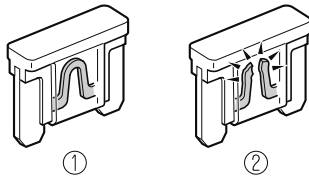

1. Normal
2. Blown

5. Insert a new fuse of the same amperage rating, and make sure it fits tightly. If it does not fit tightly, have an expert install it. We recommend an Authorised Mazda Repairer. If you have no spare fuses, borrow one of the same rating from a circuit not essential to vehicle operation, such as the audio or accessory socket circuit.

CAUTION

Always replace a fuse with a genuine Mazda fuse or equivalent of the same rating. Otherwise you may damage the electric system.

6. Reinstall the cover and make sure that it is securely installed.

Replacing the fuses under the bonnet

If the headlights or other electrical components do not work and the fuses in the cabin are normal, inspect the fuse block under the bonnet.

If a fuse is blown, it must be replaced. Follow these steps:

1. Make sure the ignition is switched off, and other switches are off.
2. Remove the fuse block cover.

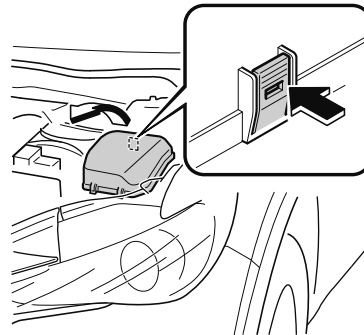

3. If any fuse but the MAIN fuse is blown, replace it with a new one **of the same amperage rating**.

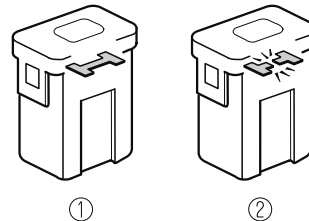

1. Normal
2. Blown

Owner Maintenance

WARNING

Do not replace the main fuse by yourself. Have an Authorised Mazda Repairer perform the replacement:
Replacing the fuse by yourself is dangerous because the MAIN fuse is a high current fuse. Incorrect replacement could cause an electrical shock or a short circuit resulting in a fire.

4. Reinstall the cover and make sure that it is securely installed.

▼ **Fuse Panel Description**

Fuse block (Engine compartment)

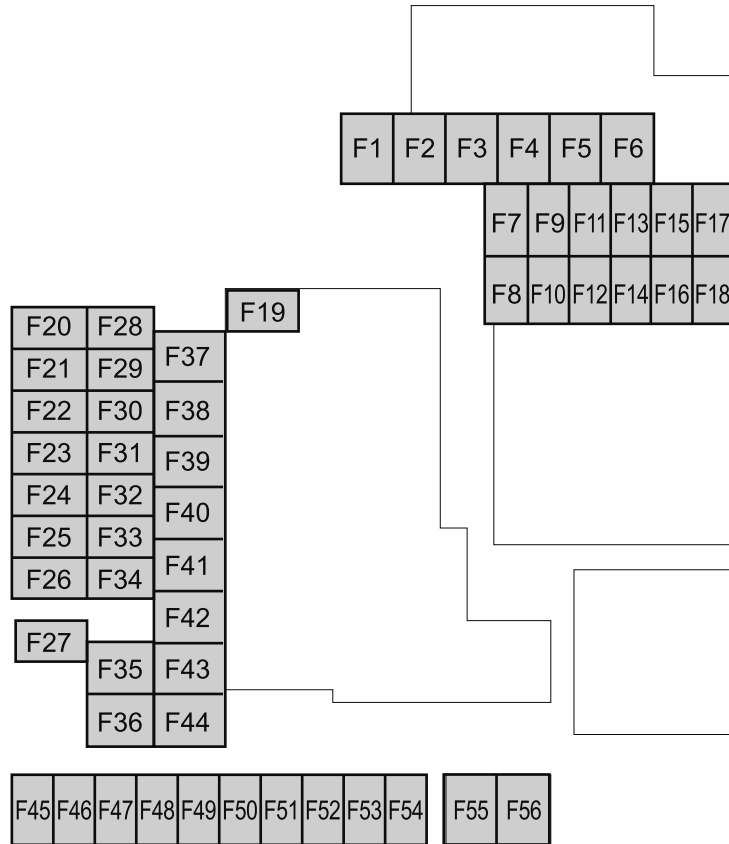

No.	FUSE RAT- ING	PROTECTED COMPONENT
F1	—	—
F2	20 A	Windscreen wiper de-icer*
F3	30 A	Engine control system
F4	20 A	S-VT
F5	40 A	Engine control system
F6	—	—
F7	20 A	Fuel pump

*Some models. **6-37**

Owner Maintenance

No.	FUSE RAT- ING	PROTECTED COMPONENT
F8	15 A	Engine control system
F9	15 A	Transmission control system*
F10	15 A	Engine control system
F11	7.5 A	Air conditioner
F12	15 A	Engine control system
F13	—	—
F14	20 A	Front seat warmer*
F15	—	—
F16	15 A	For protection of various circuits
F17	—	—
F18	15 A	Accessory sockets
F19	60 A	Electric power steering
F20	15 A	Headlight (LH) 1
F21	15 A	Headlight (RH) 1
F22	15 A	Keyless system
F23	30 A	ABS, Dynamic stability control system
F24	15 A	Headlight (LH) 2
F25	15 A	Headlight (RH) 2
F26	7.5 A	On board diagnostics
F27	25 A	For protection of various circuits
F28	25 A	For protection of various circuits
F29	15 A	Windscreen washer
F30	—	—
F31	15 A	Horn
F32	—	—
F33	—	—
F34	—	—
F35	50A	ABS, Dynamic stability control system
F36	—	—
F37	40 A	Rear window defogger
F38	50 A	For protection of various circuits
F39	—	—
F40	40 A	Air conditioner
F41	—	—
F42	20 A	Windscreen wiper

6-38

*Some models.

Maintenance and Care
Owner Maintenance

No.	FUSE RAT- ING	PROTECTED COMPONENT
F43	30 A	Cooling fan
F44	30 A	Starter
F45	10 A	Engine control system
F46	15 A	Audio
F47	15 A	For protection of various circuits
F48	7.5 A	Air bag
F49	15 A	Instrument cluster
F50	15 A	Room lamp
F51	25 A	Audio
F52	10 A	Sunroof*
F53	15 A	Engine control system
F54	15 A	i-ACTIVSENSE
F55	50 A	For protection of various circuit
F56	—	—

Fuse block (Left side)

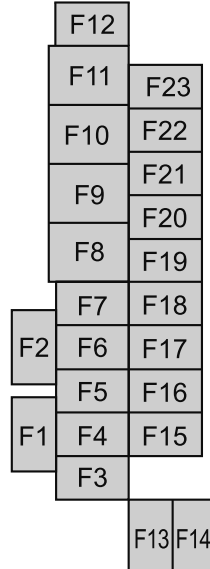

*Some models. **6-39**

Maintenance and Care

Owner Maintenance

No.	FUSE RAT- ING	PROTECTED COMPONENT
F1	—	—
F2	—	—
F3	—	—
F4	15 A	Power door locks (Driver)
F5	15 A	Power door locks (Passenger)
F6	—	—
F7	—	—
F8	—	—
F9	30 A	Power windows (Driver)
F10	30 A	Power windows (Passenger)
F11	30 A	Power seat (Driver)*
F12	—	—
F13	15 A	Audio
F14	—	—
F15	15 A	Back door lock
F16	15 A	Illumination
F17	10 A	Brake lights
F18	10 A	Back lights
F19	10 A	Rear direction indicator lights
F20	10 A	Tail lights
F21	10 A	Tail lights
F22	7.5 A	Electric steering lock
F23	—	—

6-40

*Some models.

Emission Control Maintenance (Australia)

▼ Emission Control Maintenance (Australia)

Emission control maintenance is periodically required to ensure proper emission control and engine performance. Refer to scheduled maintenance (page 6-3) for information on when and how to perform the following inspections and servicing items.

For owners with a Mazda Workshop Manual, refer to the sections on Predelivery Inspection and Scheduled Maintenance.

▼ Engine

Drive belts

Inspect the belts for cracks and other damage. Replace if necessary.

Engine oil

When changing the engine oil, use the following oil of the proper viscosity for your climate.

(Australia)

API SL/SM/SN or ILSAC GF-III/GF-IV/GF-V

(New Zealand)

API SN or higher, or ILSAC GF-V or higher

Change it more frequently during heavy use under any of these conditions:

1. Dusty environment

2. Extended idling or low-speed operations
3. Driving for a prolonged period in cold temperatures or in an extremely humid climate
4. Repeated short-distance driving

Oil filter

Do not fail to change the oil filter as prescribed. As with the engine oil, under severe driving conditions, the filter should be changed more frequently.

Cooling system

When inspecting hoses (including the heater hose), connections, and clamps, look for leaks, swellings, cracks, and other damage. Replace any defective hose or part.

Engine coolant

Change the coolant and flush the cooling system as prescribed.

▼ Fuel System and Air-Intake Control System

Fuel lines and hoses

When inspecting the fuel pipes, hoses, connections and clamps, look for leaks, deterioration, and other damage. Replace any defective hose or part.

Air filter

Besides replacing the filter regularly, always replace it if it is torn or otherwise damaged. Inspect and replace it more often than prescribed if the vehicle is used in very dusty or sandy areas.

Owner Maintenance

▼ Ignition System

Spark plugs

To maintain proper engine operation and emission control, spark plugs must always be in good condition.

▼ Evaporative Emission Control System

When inspecting evaporative line hoses and connections (including the fuel tank and filler cap), apply pressure to determine pressure-holding capacity. Replace any damaged or deteriorated parts.

▼ Exhaust Emission Control System

E.G.R. system

The EGR valve must function properly and no leaks can be evident in the pipes and connections. Replace any damaged part.

Clean the pipes, valve and connections from time to time.

WARNING

Do not touch the EGR pipes while the engine is running or until they have cooled off after the engine is stopped:

EGR pipes are extremely hot during engine operation and for a while after operation. Touching them could cause severe burns.

Exterior Care

▼ Exterior Care

The paintwork on your Mazda represents the latest technical developments in composition and methods of application.

Environmental hazards, however, can harm the paint's protective properties, if proper care is not taken.

Here are some examples of possible damage, with tips on how to prevent them.

Etching Caused by Acid Rain or Industrial Fallout

Occurrence

Industrial pollutants and vehicle emissions drift into the air and mix with rain or dew to form acids. These acids can settle on a vehicle's finish. As the water evaporates, the acid becomes concentrated and can damage the finish.

And the longer the acid remains on the surface, the greater the chance is for damage.

Prevention

It is necessary to wash and wax your vehicle to preserve its finish according to the instructions in this section. These steps should be taken immediately after you suspect that acid rain has settled on your vehicle's finish.

Damage Caused by Bird Dropping, Insects, or Tree Sap

Occurrence

Bird droppings contain acids. If these are not removed they can eat away the clear and colour base coat of the vehicle's paintwork.

When insects stick to the paint surface and decompose, corrosive compounds form. These can erode the clear and colour base coat of the vehicle's paintwork if they are not removed.

Tree sap will harden and adhere permanently to the paint finish. If you scratch the sap off while it is hard, some vehicle paint could come off with it.

Prevention

It is necessary to have your Mazda washed and waxed to preserve its finish according to the instructions in this section. This should be done as soon as possible.

Bird droppings can be removed with a soft sponge and water. If you are travelling and these are not available, a moistened tissue may also take care of the problem. The cleaned area should be waxed according to the instructions in this section.

Insects and tree sap are best removed with a soft sponge and water or a commercially available chemical cleaner.

Another method is to cover the affected area with dampened newspaper for 1 to 2 hours. After removing the newspaper, rinse off the loosened debris with water.

Appearance Care

Water Marks

Occurrence

Rain, fog, dew, and even tap water can contain harmful minerals such as salt and lime. If moisture containing these minerals settles on the vehicle and evaporates, the minerals will concentrate and harden to form white rings. The rings can damage your vehicle's finish.

Prevention

It is necessary to wash and wax your vehicle to preserve its finish according to the instructions in this section. These steps should be taken immediately after you find water marks on your vehicle's finish.

Paint Chipping

Occurrence

Paint chipping occurs when gravel thrown in the air by another vehicle's tyres hits your vehicle.

How to avoid paint chipping

Keeping a safe distance between you and the vehicle ahead reduces the chances of having your paint chipped by flying gravel.

NOTE

- *The paint chipping zone varies with the speed of the vehicle. For example, when travelling at 90 km/h (56 mph), the paint chipping zone is 50 m (164 ft).*
- *In low temperatures a vehicle's finish hardens. This increases the chance of paint chipping.*

- *Chipped paint can lead to rust forming on your Mazda. Before this happens, repair the damage by using Mazda touch-up paint according to the instructions in this section. Failure to repair the affected area could lead to serious rusting and expensive repairs.*

Follow **all** label and container directions when using a chemical cleaner or polish. Read all warnings and cautions.

▼ Maintaining the Finish

Washing



➤ *When the wiper lever is in the **AUTO** position and the ignition is switched ON, the wipers may move automatically in the following cases:*

- *If the windscreen above the rain sensor is touched or wiped with a cloth.*
- *If the windscreen is struck with a hand or other object from either outside or inside the vehicle.*

*Keep hands and scrapers clear of the windscreen when the wiper lever is in the **AUTO** position and the ignition is switched ON as fingers could be pinched or the wipers and wiper blades damaged when the wipers activate automatically. If you are going to clean the windscreen, be sure the wipers are turned off completely (when it is most likely that the engine is left running) this is particularly important when clearing ice and snow.*

Appearance Care

- *Do not spray water in the engine compartment. Otherwise, it could result in engine-starting problems or damage to electrical parts.*
- *When washing and waxing the vehicle, be careful not to apply excessive force to any single area of the vehicle roof. Otherwise, you could dent the vehicle.*
- *Make sure that the fuel-filler flap is closed and lock the doors. Otherwise, the fuel-filler flap may be forcefully opened by water pressure causing damage to the vehicle or fuel-filler flap.*

To help protect the finish from rust and deterioration, wash your Mazda thoroughly and frequently, at least once a month, with lukewarm or cold water.

If the vehicle is washed improperly, the paint surface could be scratched. Here are some examples of how scratching could occur.

Scratches occur on the paint surface when:

- The vehicle is washed without first rinsing off dirt and other foreign matter.
- The vehicle is washed with a rough, dry, or dirty cloth.
- The vehicle is washed at a car wash that uses brushes that are dirty or too stiff.
- Cleansers or wax containing abrasives are used.

NOTE

- *Mazda is not responsible for scratches caused by automatic car washes or improper washing.*
- *Scratches are more noticeable on vehicles with darker paint finishes.*

To minimize scratches on the vehicle's paint finish:

- Rinse off any dirt or other foreign matter using lukewarm or cold water before washing.
- Use plenty of lukewarm or cold water and a soft cloth when washing the vehicle. Do not use a nylon cloth.
- Rub gently when washing or drying the vehicle.
- Take your vehicle only to a car wash that keeps its brushes well maintained.
- Do not use abrasive cleansers or wax that contain abrasives.

CAUTION

- *Do not use steel wool, abrasive cleaners, or strong detergents containing highly alkaline or caustic agents on chrome-plated or anodised aluminium parts. This may damage the protective coating; also, cleaners and detergents may discolour or deteriorate the paint.*

Pay special attention to removing salt, dirt, mud, and other foreign material from the underside of the wings, and make sure the drain holes in the lower edges of the doors and rocker panels are clean.

Insects, tar, tree sap, bird droppings, industrial fallout, and similar deposits can damage the finish if not removed immediately. When prompt washing with plain water is ineffective, use a mild soap made for use on vehicles.

Appearance Care

Thoroughly rinse off all soap with lukewarm or cold water. Do not allow soap to dry on the finish.

After washing the vehicle, dry it with a clean chamois to prevent water spots from forming.

WARNING

Dry off brakes that have become wet by driving slowly, releasing the accelerator pedal and lightly applying the brakes several times until the brake performance returns to normal:

Driving with wet brakes is dangerous. Increased stopping distance or the vehicle pulling to one side when braking could result in a serious accident. Light braking will indicate whether the brakes have been affected.

When using an automatic car wash

- Retract the door mirrors.
- The automatic car wash brushes could reduce the paint lustre or hasten paint deterioration.

When using a high water pressure car wash

High water temperature and high water pressure car washers are available depending on the type of car wash machine. If the car washer nozzle is put too close to the vehicle, the force of the spray could damage or deform the molding, affect the sealability of parts, and allow water to penetrate the interior. Keep a sufficient space (30 cm (12 in) or more) between the nozzle and the vehicle. In addition, do not spend too much time spraying the same area of the vehicle, and be very careful when spraying between gaps in doors and around windows.

Waxing

Your vehicle needs to be waxed when water no longer beads on the finish. Always wash and dry the vehicle before waxing it. In addition to the vehicle body, wax the metal trim to maintain its lustre.

1. Use wax which contains no abrasives. Waxes containing abrasive will remove paint and could damage bright metal parts.
2. Use a good grade of natural wax for metallic, mica, and solid colours.
3. When waxing, coat evenly with the sponge supplied or a soft cloth.
4. Wipe off the wax with a soft cloth.

NOTE

A spot remover to remove oil, tar, and similar materials will usually also take off the wax. Rewax these areas even if the rest of the vehicle does not need it.

▼ Paint Damage Touch-up

Repair damage to the finish caused by stone chipping, damage during parking etc., by using Mazda touch-up paint before rust begins to form. First, remove the dirt and grease with a clean soft cloth.

If rust has already begun to form:

1. Remove rust completely with sandpaper.
2. Wipe with a clean soft cloth.
3. Apply rust preventive primer to the area.
4. After drying it completely, apply a suitable top coat material to the area.

Of course there will be no problem if you assign the work to an expert repairer, we recommend an Authorised Mazda Repairer.

▼ Cavity Protection

Cavities are treated for protection at the factory, but additional protective treatment after the vehicle has been put into use will extend the life of the body.

We recommend that you consult an expert repairer, we recommend an Authorised Mazda Repairer concerning this additional precaution.

▼ Bright-Metal Maintenance

- Use tar remover to remove road tar and insects. Never do this with a knife or similar tool.
- To prevent corrosion on bright-metal surfaces, apply wax or chrome preservative and rub it to a high lustre.
- During cold weather or in coastal areas, cover bright-metal parts with a coating of wax or preservative heavier than usual. It would also help to coat them with noncorrosive petroleum jelly or some other protective compound.

⚠ CAUTION

Do not use steel wool, abrasive cleaners, or strong detergents containing highly alkaline or caustic agents on chrome-plated or anodised aluminium parts. This may result in damage to the protective coating and cause discolouration or paint deterioration.

▼ Undercoating

This special coating is applied to the critical parts of the underside to protect vehicles from damage caused by chemicals or stones. This coating is liable to be damaged with time. Check this coating periodically.

Should repairs be necessary, consult an expert repairer, we recommend an Authorised Mazda Repairer. They are well informed on how repairs should be made.

Appearance Care

▼ Aluminium Wheel Maintenance*

A protective coating is provided over the aluminium wheels. Special care is needed to protect this coating.



Do not use any detergent other than mild detergent. Before using any detergent, verify the ingredients. Otherwise, the product could discolour or stain the aluminium wheels.

NOTE

- *Do not use a wire brush or any abrasive cleaner, polishing compound, or solvent on aluminium wheels. They may damage the coating.*
- *Always use a sponge or soft cloth to clean the wheels.
Rinse the wheels thoroughly with lukewarm or cold water. Also, be sure to clean the wheels after driving on dusty or salted roads to help prevent corrosion.*
- *Avoid washing your vehicle in an automatic car wash that uses high-speed or hard brushes.*

▼ Plastic Part Maintenance

- When cleaning the plastic lenses of the lights, do not use petrol, paraffin, rectified spirit, paint, thinner, highly acidic detergents, or strongly alkaline detergents. Otherwise, these chemical agents can discolour or damage the surfaces resulting in a significant loss in functionality. If plastic parts become inadvertently exposed to any of these chemical agents, flush with water immediately.

- If plastic parts such as the bumpers become inadvertently exposed to chemical agents or fluids such as petrol, oil, engine coolant, or battery fluid, it could cause discolouration, staining, or paint peeling. Wipe off any such chemical agents or fluids using a soft cloth immediately.
- High water temperature and high water pressure car washers are available depending on the type of high pressure car washer device. If the car washer nozzle is put too close to the vehicle or aimed at one area for an extended period of time, it could deform plastic parts or damage the paint.
- Do not use wax containing compounds (polish). Otherwise, it could result in paint damage.
- In addition, do not use an electrical or air tool to apply wax. Otherwise, the frictional heat generated could result in deformation of plastic parts or paint damage.

6-48 *Some models.

Interior Care

▼ Interior Care

WARNING

Do not spray water into the vehicle cabin:
Spraying water into the vehicle cabin is dangerous as electrical devices such as the audio and switches could get wet resulting in a malfunction or vehicle fire.

NOTE

- Do not wipe the interior using alcohol, chlorine bleach, or organic solvents such as thinner, benzene, and petrol. Otherwise, it may cause discolouration or stains.
- Rubbing hard with a stiff brush or cloth may cause damage.

If the vehicle interior becomes soiled by any of the following, wipe it off immediately using a soft cloth. Leaving it uncleaned could cause discolouration, stains, cracks, or peeling of the coating, and it will make it hard to wipe off later.

- Beverage or fragrance
- Grease or oil
- Soiling

▼ Seat Belt Maintenance

1. Clean the soiled area by lightly dabbing it with a soft cloth soaked in a mild detergent (approx. 5%) diluted with water.
2. Wipe off the remaining detergent using a cloth soaked in clean water and wrung out well.

3. Before retracting seat belts which have been pulled out for cleaning, dry them off thoroughly and make sure there is no remaining moisture on them.

WARNING

If a seat belt appears frayed or has abrasions, have it replaced by an Authorised Mazda Repairer:

If a seat belt is used under such a condition, it cannot function at its full capacity which could result in serious injury or death.

Use a mild detergent to remove soiling from a seat belt:

If organic solvents are used for cleaning the seat belts or they become stained or bleached, there is the possibility of them becoming weakened and as a result, they may not function at their full capacity which could cause serious injury or death.

NOTE

Clean seat belts diligently if they get dirty. Leaving them uncleaned will make it difficult to clean them later, and it may affect the smooth retracting of the seat belt.

Appearance Care

▼ Vinyl Upholstery Maintenance

Remove dust and dirt from the vinyl upholstery using a brush or vacuum. Remove soiling from vinyl upholstery using a leather and vinyl upholstery cleaner.

▼ Upholstery Maintenance

1. Clean the soiled area by lightly dabbing it with a soft cloth soaked in a mild detergent (approx. 5%) diluted with water.
2. Wipe off the remaining detergent using a cloth soaked in clean water and wrung out well.

▼ Leather Upholstery Maintenance*

1. Remove dust and sand using a vacuum cleaner.
2. Wipe off the soiled area with a soft cloth and a suitable, special cleaner or a soft cloth soaked in a mild detergent (about 5%) diluted with water.
3. Wipe off the remaining detergent using a cloth soaked in clean water and wrung out well.
4. Remove moisture with a dry, soft cloth and allow the leather to further dry in a well-ventilated, shaded area. If the leather gets wet such as from rain, remove the moisture and dry it as soon as possible.

NOTE

- Because genuine leather is a natural material, its surface is not uniform and it may have natural scars, scratches, and wrinkles.
- To maintain the quality for as long as possible, periodical maintenance, about twice a year, is recommended.

6-50

*Some models.

· If the leather upholstery comes into contact with any of the following, clean it immediately.

Leaving it uncleaned could cause premature wear, mold, or stains.

- Sand or dirt
- Grease or oil, such as hand cream
- Alcohol, such as in cosmetic or hair dressing items

· If the leather upholstery gets wet, promptly remove moisture with a dry cloth. Remaining moisture on the surface may cause deterioration such as hardening and shrinkage.

· Exposure to direct sunlight for long periods may cause deterioration and shrinkage. When parking the car under direct sunlight for long periods, shade the interior using sunshades.

· Do not leave vinyl products on the leather upholstery for long periods. They may affect the leather quality and colouring. If the cabin temperature becomes hot, the vinyl may deteriorate and adhere to the genuine leather.

▼ Plastic Part Maintenance

CAUTION

Do not use polishing agents. Depending on the product ingredients, they could cause discolouration, stains, cracks or peeling of the coating.

▼ Instrument Panel Top (Soft pad) Maintenance

Extremely soft material is used for the soft pad surface. If the soft pad surface is rubbed harshly with a dry cloth, it could result in the surface being damaged and leaving white scratch marks.

1. Wipe the soiled area with a soft cloth soaked in a mild detergent (approx. 5%) diluted with water.
2. Wipe off the remaining detergent using a cloth soaked in clean water and wrung out well.

▼ Active Driving Display Maintenance

The dust-proof sheet has a coating. When cleaning, do not use a hard or rough-surface cloth, or cleaning detergent. In addition, if a chemical solvent gets on the active driving display, wipe it off immediately. The dust-proof sheet could be damaged and the surface coating could be scratched. Use a fine, soft cloth such as those used for cleaning eyeglasses.

NOTE

Use of compressed air when cleaning the dust-proof sheet is recommended.

▼ Panel Maintenance

If a panel becomes soiled, wipe it off with a soft cloth soaked in clean water and thoroughly wrung out.

If some areas require further cleaning, use the following procedure:

1. Wipe the soiled area with a soft cloth soaked in a mild detergent (approx. 5 %) diluted with water.
2. Wipe off the remaining detergent using a cloth soaked in clean water and wrung out well.

NOTE

Be particularly careful when cleaning shiny surface panels and metallic parts such as plating as they can be scratched easily.

▼ Cleaning the Window Interiors

If the windows become covered with an oily, greasy, or waxy film, clean them with glass cleaner. Follow the directions on the container.



- *Do not scrape or scratch the inside of the window glass. It could damage the thermal filaments and the aerial lines.*
- *When washing the inside of the window glass, use a soft cloth dampened in lukewarm water, gently wiping the thermal filaments and the aerial lines. Use of glass cleaning products could damage the thermal filaments and the aerial lines.*

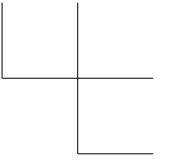
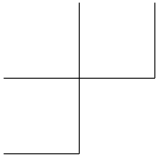

MEMO

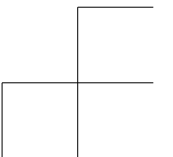
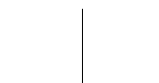
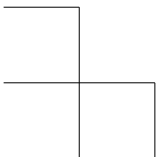
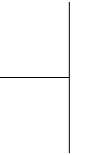
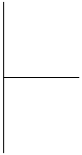

7

If Trouble Arises

Helpful information on what to do if a problem arises with the vehicle.

Parking in an Emergency.....	7-2	Warning/Indicator Lights and	
Parking in an Emergency.....	7-2	Warning Sounds.....	7-23
		If a Warning Light Turns On or	
Flat Tyre.....	7-3	Flashes.....	7-23
Spare Tyre and Tool Storage.....	7-3	Message Indicated on Multi-	
Changing a Flat Tyre.....	7-7	information Display.....	7-34
		Warning Sound is Activated.....	7-37
Battery Runs Out.....	7-13		
Jump-Starting.....	7-13	When Liftgate/Boot Lid Cannot be	
		Opened.....	7-42
Emergency Starting.....	7-16	When Liftgate/Boot Lid Cannot be	
Starting a Flooded Engine.....	7-16	Opened.....	7-42
Push-Starting.....	7-16		
Overheating.....	7-17	Active Driving Display Does Not	
Overheating.....	7-17	Operate.....	7-44
		If the Active Driving Display Does	
Emergency Towing.....	7-19	Not Operate.....	7-44
Towing Description.....	7-19		
Towing Hooks.....	7-20	Windscreen Wipers Operate at High	
		Speed.....	7-45
		Windscreen Wipers Operate at High	
		Speed.....	7-45

If Trouble Arises

Parking in an Emergency

Parking in an Emergency

▼ Parking in an Emergency

The hazard warning lights should always be used when you stop on or near a roadway in an emergency.

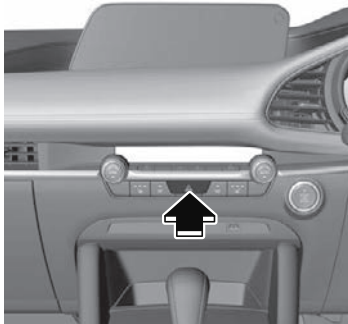

The hazard warning lights warn other drivers that your vehicle is a traffic hazard and that they must take extreme caution when near it.



Depress the hazard warning flasher and all the direction indicators will flash. The hazard warning indicator lights in the instrument cluster flash simultaneously.

NOTE

- *The direction indicators do not work when the hazard warning lights are on.*
- *Check local regulations about the use of hazard warning lights while the vehicle is being towed to verify that it is not in violation of the law.*

7-2

Spare Tyre and Tool Storage

▼ Spare Tyre and Tool Storage

Spare tyre and tools are stored in the locations illustrated in the diagram.

Saloon

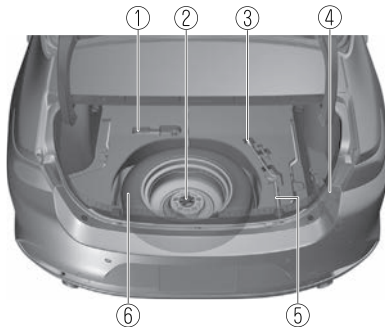

1. Towing eyelet*
2. Spare tyre hold-down bolt
3. Jack lever
4. Jack
5. Wheel brace
6. Spare tyre

Hatchback

Type A

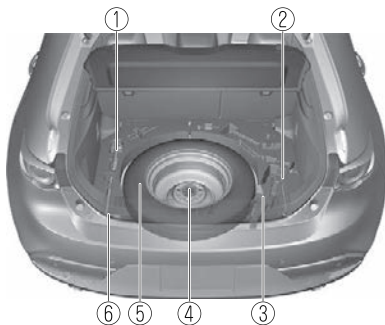

1. Towing eyelet*
2. Jack lever

3. Jack
4. Spare tyre hold-down bolt
5. Spare tyre
6. Wheel brace

Type B

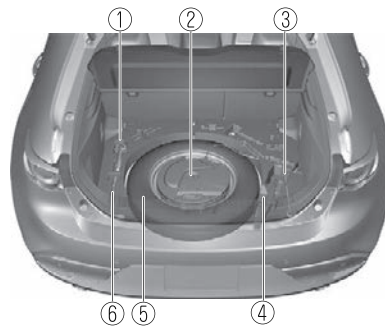

1. Towing eyelet*
2. Spare tyre hold-down bolt
3. Jack lever
4. Jack
5. Spare tyre
6. Wheel brace

▼ Jack

To remove the jack

Saloon

1. Remove the boot mat.



*Some models.

If Trouble Arises
Flat Tyre

2. Remove the cover.



3. Turn the wing bolt and jack screw anticlockwise.

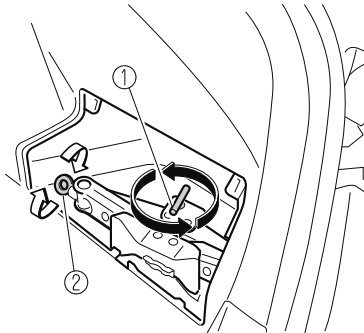

1. Wing bolt
2. jack screw

Hatchback

1. Remove the luggage mat.



2. Remove the jack.



To secure the jack

Saloon

1. Insert the wing bolt into the jack with the jack screw pointing to the front and turn the wing bolt clockwise to temporarily tighten it.
2. Turn the jack screw clockwise.

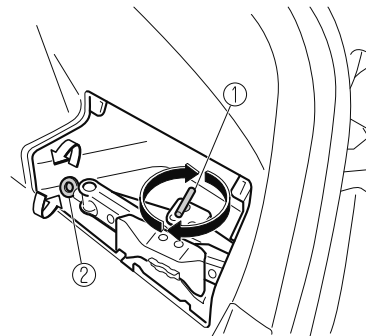

1. Wing bolt
2. jack screw

3. Turn the wing bolt completely to secure the jack.

NOTE

If the jack is not completely secured, it could rattle while driving. Make sure the jack screw is sufficiently tightened.

Hatchback

Perform the removal procedure in reverse.

Maintenance

- Always keep the jack clean.
- Make sure the moving parts are kept free from dirt or rust.
- Make sure the screw thread is adequately lubricated.

▼ Spare Tyre

Your Mazda has a temporary spare tyre. The temporary spare tyre is lighter and smaller than a conventional tyre, and is designed only for emergency use and should be used only for VERY short periods. Temporary spare tyres should NEVER be used for long drives or extended periods.

⚠ WARNING

Do not install the temporary spare tyre on the front wheels (driving wheels):

Driving with the temporary spare tyre on one of the front driving wheels is dangerous. Handling will be affected. You could lose control of the vehicle, especially on ice or snow bound roads, and have an accident. Move a regular tyre to the front wheel and install the temporary spare tyre to the rear.

⚠ CAUTION

- *When using the temporary spare tyre, driving stability may decrease compared to when using only the conventional tyre. Drive carefully.*

➤ *To avoid damage to the temporary spare tyre or to the vehicle, observe the following precautions:*

- *Do not exceed 80 km/h (50 mph).*
- *Avoid driving over obstacles. Also, do not drive through an automatic car wash. This tyre's diameter is smaller than a conventional tyre, so the ground clearance is reduced.*
- *Do not use a tyre chain on this tyre because it will not fit properly.*
- *Do not use your temporary spare tyre on any other vehicle, it has been designed only for your Mazda.*
- *Use only one temporary spare tyre on your vehicle at the same time.*

To remove the spare tyre

Saloon

1. Remove the boot mat.



If Trouble Arises
Flat Tyre

2. Turn the spare tyre hold-down bolt anticlockwise and remove the spare tyre.

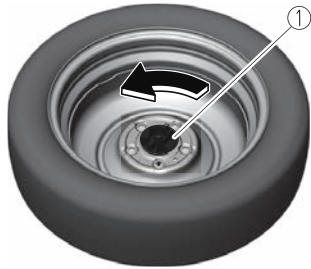

1. Spare tyre hold-down bolt

Hatchback

1. Remove the luggage mat.



2. **(Vehicles with sub-woofer)**
Uncouple the sub-woofer connector.

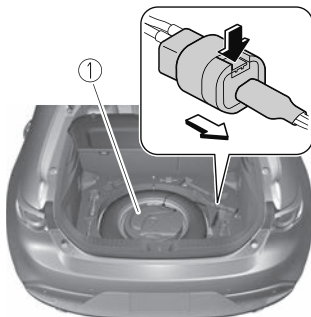

7-6

1. Sub-woofer

NOTE

Extra strength may be required to uncouple the connector. Be sure to squeeze the tab firmly.

3. **(Vehicles with sub-woofer)**
Turn the spare tyre hold-down bolt anticlockwise and remove the sub-woofer and the spare tyre.



(Vehicles without sub-woofer)

Turn the spare tyre hold-down bolt anticlockwise and remove the spare tyre.

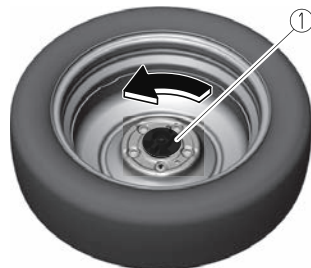

1. Spare tyre hold-down bolt

To secure the spare tyre

Store the spare tyre in the reverse order of removal. After storing, verify that the spare tyre is stored securely.

Changing a Flat Tyre

▼ Changing a Flat Tyre

NOTE

If the following occurs while driving, it could indicate a flat tyre.

- *Steering becomes difficult.*
- *The vehicle begins to vibrate excessively.*
- *The vehicle pulls in one direction.*

If you have a flat tyre, drive slowly to a level spot that is well off the road and out of the way of traffic to change the tyre. Stopping in traffic or on the shoulder of a busy road is dangerous.

⚠ WARNING

Be sure to follow the directions for changing a tyre:

Changing a tyre is dangerous if not done properly. The vehicle can slip off the jack and seriously injure someone.

No person should place any portion of their body under a vehicle that is supported by a jack.

Never allow anyone inside a vehicle supported by a jack:

Allowing someone to remain in a vehicle supported by a jack is dangerous. The occupant could cause the vehicle to fall resulting in serious injury.

NOTE

Make sure the jack is well lubricated before using it.

1. Park on a hard, level surface off the right-of-way and firmly set the parking brake.
2. Put a vehicle with an automatic transmission in Park (P), a manual transmission in Reverse (R) or 1, and turn off the engine.
3. Turn on the hazard warning flasher.
4. Have everyone get out of the vehicle and away from the vehicle and traffic.
5. Remove the jack, tool, and spare tyre (page 7-3).
6. Block the wheel diagonally opposite the flat tyre. When blocking a wheel, place a tyre block both in front and behind the tyre.



NOTE

When blocking a tyre, use rocks or wood blocks of sufficient size if possible to hold the tyre in place.

Flat Tyre

▼ Removing a Flat Tyre

WARNING

When jacking-up a vehicle, always shift the shift lever to 1st or R position (manual transmission vehicle) or shift the selector lever to P position (automatic transmission vehicle), apply the parking brake, and place wheel blocks in the position diagonally opposed to the jack:

Changing a flat tyre without using wheel blocks is dangerous because the vehicle may move and fall off the jack even with the shift lever in 1st or R position, or the selector lever is in P position, which could result in an accident.

1. If your vehicle is equipped with a wheel cover, pry off the wheel cover with the bevelled end of the jack lever.



NOTE

Force the end of the jack lever firmly between wheel and cover, or removal will be difficult.

CAUTION

Align the notch on the wheel cover with the valve stem when installing it.

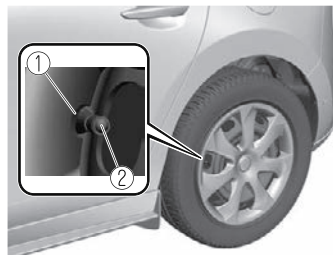

1. Notch
2. Tyre valve

Damage could occur during installation if the wheel cover is not properly aligned.

2. Loosen the wheel nuts by turning them anticlockwise one turn each, but do not remove any wheel nuts until the tyre has been raised off the ground.

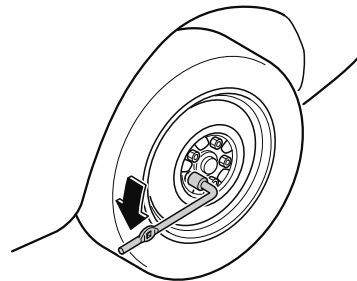

3. Place the jack on the ground.

If Trouble Arises
Flat Tyre

4. Turn the jack screw in the direction shown in the figure and adjust the jack head so that it is close to the jack-up position.

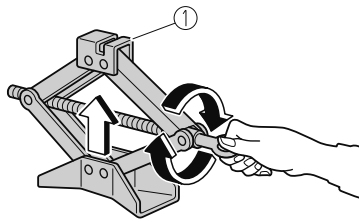

1. Jack head

5. Place the jack under the jack-up position closest to the tyre being changed with the jack head squarely under the jack-up point.

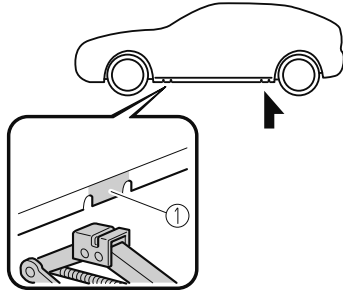

1. Jacking position

6. Continue raising the jack head gradually by rotating the screw with your hand until the jack head is inserted into the jack-up position.

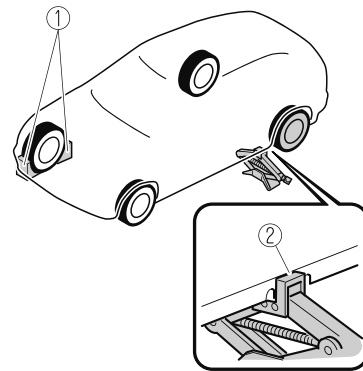

1. Tyre blocks
2. Jacking position

! WARNING

Use only the front and rear jacking positions recommended in this manual: Attempting to jack the vehicle in positions other than those recommended in this manual is dangerous. The vehicle could slip off the jack and seriously injure or even kill someone. Use only the front and rear jacking positions recommended in this manual.

If Trouble Arises

Flat Tyre

Do not jack up the vehicle in a position other than the designated jack-up position or place any objects on or under the jack:

Jacking up the vehicle in a position other than the designated jack-up position or placing objects on or under the jack is dangerous as it could deform the vehicle body or the vehicle could fall off the jack resulting in an accident.

Use only the jack provided with your Mazda:

Using a jack that is not designed for your Mazda is dangerous. The vehicle could slip off the jack and seriously injure someone.

Never place objects under the jack:

Jacking the vehicle with an object under the jack is dangerous. The jack could slip and someone could be seriously injured by the jack or the falling vehicle.

NOTE

When raising the jack head into the jacking position and aligning the groove in the jack head with the rail under the vehicle body, the top of the jack head contacts the vehicle's underbody without the rail contacting the bottom of the groove.

7. Insert the jack lever and attach the wheel brace to tyre jack.

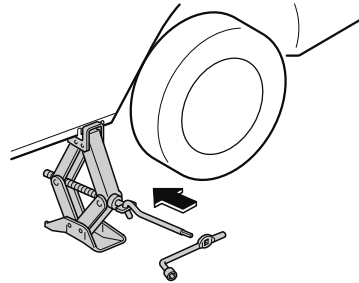

8. Turn the jack handle clockwise and raise the vehicle high enough so that the spare tyre can be installed. Before removing the wheel nuts, make sure your Mazda is firmly in position and that it cannot slip or move.

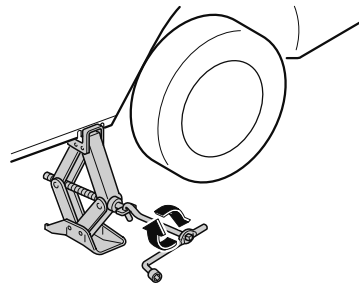

! WARNING

Do not jack up the vehicle higher than is necessary:

Jacking up the vehicle higher than is necessary is dangerous as it could destabilize the vehicle resulting in an accident.

Do not start the engine or shake the vehicle while it is jacked up:

Starting the engine or shaking the vehicle while it is jacked up is dangerous as it could cause the vehicle to fall off the jack resulting in an accident.

Never go under the vehicle while it is jacked up:

Going under the vehicle while it is jacked up is dangerous as it could result in death or serious injury if the vehicle were to fall off the jack.

9. Remove the wheel nuts by turning them anticlockwise; then remove the wheel and centre cap.

▼ Mounting the Spare Tyre

1. Remove dirt and grime from the mounting surfaces of the wheel and hub, including the hub bolts, with a cloth.

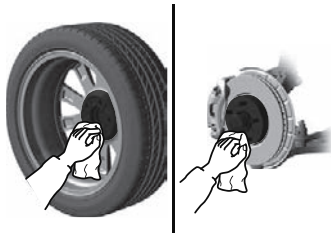
**! WARNING****Make sure the mounting surfaces of the wheel, hub and wheel nuts are clean before changing or replacing tyres:**

When changing or replacing a tyre, not removing dirt and grime from the mounting surfaces of the wheel, hub and hub bolts is dangerous. The wheel nuts could loosen while driving and cause the tyre to come off, resulting in an accident.

2. Mount the spare tyre.
3. Install the wheel nuts with the bevelled edge inward; tighten them by hand.

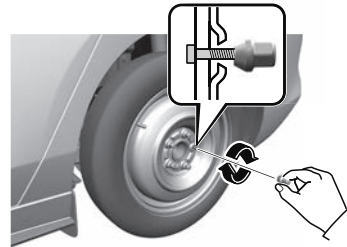
**! WARNING****Do not apply oil or grease to wheel nuts and bolts and do not tighten the wheel nuts beyond the recommended tightening torque:**

Applying oil or grease to wheel nuts and bolts is dangerous. The wheel nuts could loosen while driving and cause the tyre to come off, resulting in an accident. In addition, wheel nuts and bolts could be damaged if tightened more than necessary.

If Trouble Arises

Flat Tyre

4. Turn the jack handle anticlockwise using the wheel brace and lower the vehicle.
5. Use the wheel brace to tighten the nuts in the order shown.



If you are unsure of how tight the nuts should be, have them inspected at an expert repairer, we recommend an Authorised Mazda Repairer.

Nut tightening torque	
N·m (kgf·m, ft·lbf)	108—147 (12—14, 80—108)

WARNING

Always securely and correctly tighten the wheel nuts:
Improperly or loosely tightened wheel nuts are dangerous. The wheel could wobble or come off. This could result in loss of vehicle control and cause a serious accident.

Be sure to reinstall the same nuts you removed or replace them with metric nuts of the same configuration:

Because the wheel studs and wheel nuts on your Mazda have metric threads, using a non-metric nut is dangerous. On a metric stud, it would not secure the wheel and would damage the stud, which could cause the wheel to slip off and cause an accident.

6. Remove the tyre blocks and store the tools and jack.
7. Store the damaged tyre in the luggage compartment.
8. Check the inflation pressure. Refer to Tyres on page 9-6.
9. Have the flat tyre repaired or replaced as soon as possible.

WARNING

Do not drive with any tyres that have incorrect air pressure:

Driving on tyres with incorrect air pressure is dangerous. Tyres with incorrect pressure could affect handling and result in an accident. When you check the regular tyres' air pressure, check the spare tyre, too.

NOTE

To prevent the jack and tool from rattling, store them properly.

Battery Runs Out

Jump-Starting

▼ Jump-Starting

Jump-starting is dangerous if done incorrectly. So follow the procedure carefully. If you feel unsure about jump-starting, we strongly recommend that you have a competent service technician do the work.

WARNING



Follow These Precautions Carefully:

To ensure safe and correct handling of the battery, read the following precautions carefully before using the battery or inspecting it.



Keep flames and sparks away from open battery cells and do not allow metal tools to contact the positive (+) or negative (-) terminal of the battery when working near a battery.

Do not allow the positive (+) terminal to contact the vehicle body:

Flames and sparks near open battery cells are dangerous. Hydrogen gas, produced during normal battery operation, could ignite and cause the battery to explode. An exploding battery can cause serious burns and injuries. Keep all flames including cigarettes and sparks away from open battery cells.



Keep all flames and sparks away from open battery cells because hydrogen gas is produced from open battery cells while charging the battery or adding battery fluid:

Flames and sparks near open battery cells are dangerous. Hydrogen gas, produced during normal battery operation, could ignite and cause the battery to explode. An exploding battery can cause serious burns and injuries. Keep all flames including cigarettes and sparks away from open battery cells.

Do not jump-start a frozen battery or one with a low fluid level:

Jump-starting a frozen battery or one with a low fluid level is dangerous. It may rupture or explode, causing serious injury.

If Trouble Arises

Battery Runs Out

Connect the negative lead to a good ground point away from the battery:

Connecting the end of the second jumper lead to the negative (-) terminal of the discharged battery is dangerous.

A spark could cause the gas around the battery to explode and injure someone.

Route the jumper leads away from parts that will be moving:

Connecting a jumper lead near or to moving parts (cooling fans, belts) is dangerous. The lead could get caught when the engine starts and cause serious injury.



Use only a 12 V booster system. You can damage a 12 V starter, ignition system, and other electrical parts beyond repair with a 24 V power supply (two 12 V batteries in series or a 24 V motor generator set).

1. Move the booster vehicle so that its battery is as close as possible to your vehicle's battery.
2. Make sure that the power such as for the headlights and air conditioner is turned off.
3. Remove the battery cover.

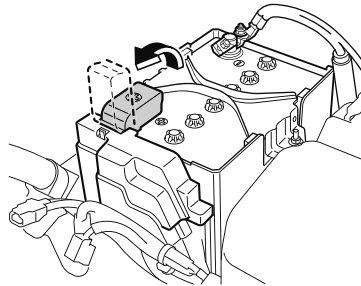

4. Turn off the booster vehicle's engine and connect the jumper leads in the following order.
Make sure that the jumper leads are securely connected so that they do not disconnect due to engine vibrations.

1st lead

- ① Positive (+) terminal on the discharged battery
- ② Positive (+) terminal on booster vehicle's battery

2nd lead

- ③ Negative (-) terminal on booster vehicle's battery

If Trouble Arises

Battery Runs Out

④ Location shown in the figure (do not connect to the negative (-) terminal of the battery)

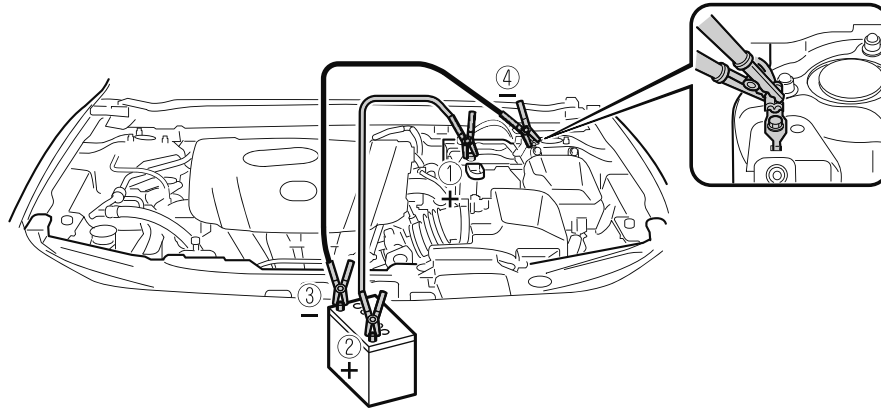

5. Start the booster vehicle's engine and rev the engine.
6. Start the engine of your vehicle. Run the engines for about 3 minutes to temporarily charge the battery of your vehicle.
7. Disconnect the jumper leads in the reverse order of their connection.
8. Install the battery cover.
9. Have your vehicle inspected by an expert repairer, we recommend an Authorised Mazda Repairer as soon as possible.

If Trouble Arises

Emergency Starting

Starting a Flooded Engine

▼ Starting a Flooded Engine

If the engine fails to start, it may be flooded (excessive fuel in the engine).

Follow this procedure:

1. If the engine does not start within 5 seconds on the first try, wait 10 seconds and try again.
2. Make sure the parking brake is on.
3. Depress the accelerator all the way and hold it there.
4. Depress the clutch pedal (manual transmission) or the brake pedal (automatic transmission), then press the push button start. If the engine starts, release the accelerator immediately because the engine will suddenly rev up.
5. If the engine fails to start, crank it without depressing the accelerator.

If the engine still does not start using the previous procedure, have your vehicle inspected by an expert repairer, we recommend an Authorised Mazda Repairer.

Push-Starting

▼ Push-Starting

Do not push-start your Mazda.



Never tow a vehicle to start it:

Towing a vehicle to start it is dangerous. The vehicle being towed could surge forward when its engine starts, causing the 2 vehicles to collide. The occupants could be injured.



Do not push-start a vehicle that has a manual transmission. It can damage the emission control system.

NOTE

You cannot start a vehicle with an automatic transmission by pushing it.

Overheating

Overheating

▼ Overheating

If the engine coolant temperature gauge indicates overheating and the high engine coolant temperature warning indication is displayed, the vehicle loses power or you hear a loud knocking or pinging noise, the engine is probably too hot.

WARNING



Pull over to a safe location, then switch the ignition off and make sure the fan is not running before attempting to work near the cooling fan:

Working near the cooling fan when it is running is dangerous. The fan could continue running indefinitely even if the engine has stopped and the engine compartment temperature is high. You could be hit by the fan and seriously injured.

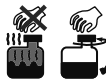

Do not remove either cooling system cap when the engine and radiator are hot:

When the engine and radiator are hot, scalding coolant and steam may shoot out under pressure and cause serious injury.

Open the bonnet ONLY after steam is no longer escaping from the engine:

Steam from an overheated engine is dangerous. The escaping steam could seriously burn you.

If the engine coolant temperature gauge indicates overheating and the high engine coolant temperature warning indication is displayed:

1. Drive safely to the side of the road and park off the right-of-way.
2. Put a vehicle with an automatic transmission in park (P), a manual transmission in neutral.
3. Apply the parking brake.
4. Turn off the air conditioner.
5. Check whether coolant or steam is escaping from the engine compartment.

If steam is coming from the engine compartment:

Do not go near the front of the vehicle. Stop the engine.

Wait until the steam dissipates, then open the bonnet and start the engine.

If neither coolant nor steam is escaping:

Open the bonnet and idle the engine until it cools.

CAUTION

If the cooling fan does not operate while the engine is running, the engine temperature will increase. Stop the engine and call an expert repairer, we recommend an Authorised Mazda Repairer.

6. Make sure the cooling fan is operating, then turn off the engine after the temperature has decreased.

If Trouble Arises

Overheating

7. When cool, check the coolant level.
If it is low, look for coolant leaks from the radiator and hoses.

If you find a leak or other damage, or if coolant is still leaking:

Stop the engine and call an expert repairer, we recommend an Authorised Mazda Repairer.

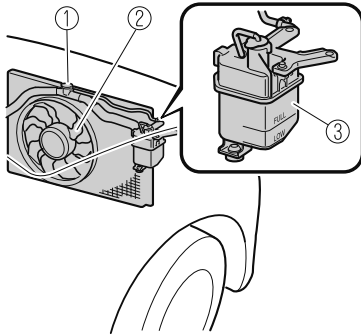

1. Cooling system cap
2. Cooling fan
3. Coolant reservoir

If you find no problems, the engine is cool, and no leaks are obvious:

Carefully add coolant as required (page 6-15).



If the engine continues to overheat or frequently overheats, have the cooling system inspected. The engine could be seriously damaged unless repairs are made. Consult an expert repairer, we recommend an Authorised Mazda Repairer.

Emergency Towing

Towing Description

▼ Towing Description

We recommend that towing be done only by an expert repairer, we recommend an Authorised Mazda Repairer or a commercial tow-truck service.

Proper lifting and towing are necessary to prevent damage to the vehicle. Government and local laws must be followed.

A towed vehicle usually should have its drive wheels (front wheels) off the ground. If excessive damage or other conditions prevent this, use wheel dollies.

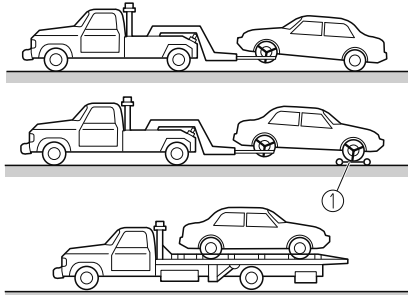

1. Wheel dollies

When towing with the rear wheels on the ground, release the parking brake. Refer to Electric Parking Brake (EPB) on page 4-64.

⚠ CAUTION

- Do not tow the vehicle pointed backward with driving wheels on the ground. This may cause internal damage to the transmission.

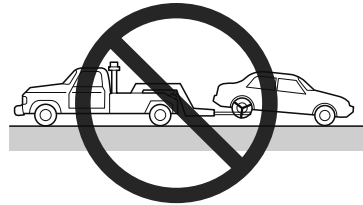

- Do not tow with sling-type equipment. This could damage your vehicle. Use wheel-lift or flatbed equipment.

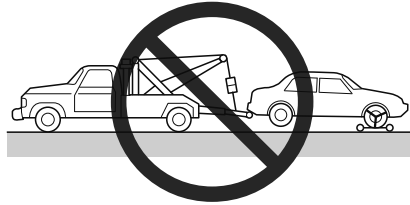

- If the parking brake cannot be released when towing the vehicle, transport the vehicle with all front and rear wheels raised off the ground as shown in the figure. If the vehicle is towed without raising the wheels off the ground, the brake system could be damaged.

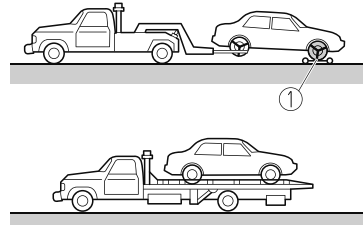

1. Wheel dollies

If Trouble Arises

Emergency Towing

If towing service is not available in an emergency, the vehicle may be towed with all four wheels on the ground using the towing hook at the front of the vehicle. Only tow the vehicle on paved surfaces for short distances at low speeds.

CAUTION

Follow these instructions when towing the vehicle with all wheels on the ground.

- Shift to neutral (Manual transmission), or the N position (Automatic transmission).
- Switch the ignition to ACC or ON.
- Release the parking brake.
Refer to Electric Parking Brake (EPB) on page 4-64.

Remember that power assist for the brakes and steering will not be available when the engine is not running.

Towing Hooks

▼ Towing Hooks

CAUTION

- The towing eyelet should be used in an emergency (to get the vehicle out of a ditch or a snow bank, for example).
- When using the towing eyelets, always pull the lead or chain in a straight direction with respect to the eyelet. Never apply a sideways force.

NOTE

When towing with chain or lead, wrap the chain or lead with a soft cloth near the bumper to prevent damage to the bumper.

1. Remove the towing eyelet and the wheel brace from the luggage compartment (page 7-3).
2. Wrap a flathead screwdriver or similar tool with a soft cloth to prevent damage to a painted bumper, and open the cap located on the front or rear bumper.

Front (Saloon)

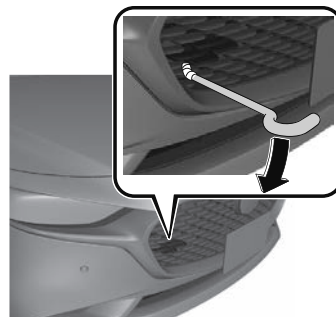

Emergency Towing

(Hatchback)

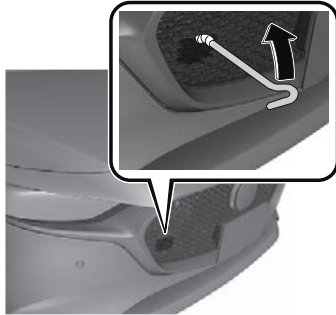

Rear
(Saloon)

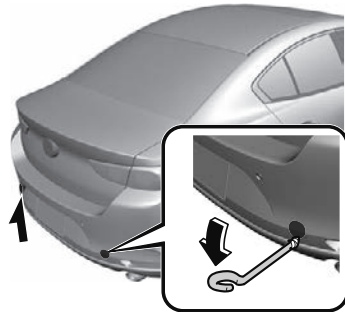

(Hatchback)

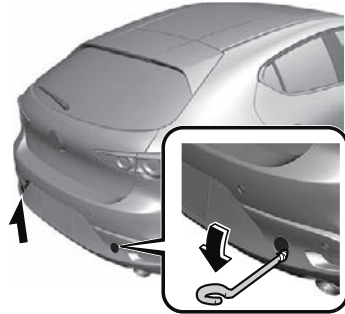

CAUTION

Do not use excessive force as it may damage the cap or scratch the painted bumper surface.

NOTE

Remove the cap completely and store it so as not to lose it.

3. Securely install the towing eyelet using the wheel brace. Consult an Authorised Mazda Repairer.

Front
(Saloon)



1. Wheel brace
2. Towing eyelet

(Hatchback)



1. Wheel brace
2. Towing eyelet

If Trouble Arises

Emergency Towing

Rear (Saloon)

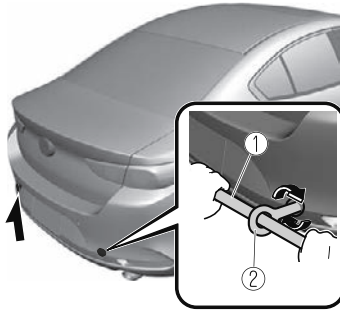

1. Wheel brace
2. Towing eyelet

(Hatchback)

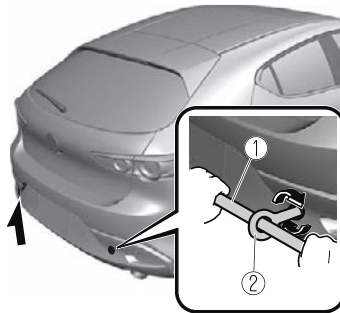

1. Wheel brace
2. Towing eyelet
4. Hook the towing rope to the towing eyelet.

CAUTION

- If the towing eyelet is not securely tightened, it may loosen or disengage from the bumper when towing the vehicle. Make sure that the towing eyelet is securely tightened to the bumper.

- Be careful not to damage the towing eyelet and towing hook, vehicle body, or transmission system when towing under the following conditions:

- Do not tow a vehicle heavier than yours.
- Do not suddenly accelerate your vehicle as it will apply a severe shock to the towing eyelet and towing hook or rope.
- Do not attach any rope other than to the towing eyelet and towing hook.

Warning/Indicator Lights and Warning Sounds

If a Warning Light Turns On or Flashes

▼ If a Warning Light Turns On or Flashes

If any warning light turns on/flashes, take appropriate action for each light. There is no problem if the light turns off, however if the light does not turn off or turns on/flashes again, consult an Authorised Mazda Repairer.

The details for some warnings can be viewed on the centre display or multi-information display in the instrument cluster.

Centre display

1. Select “Information” on the home screen.
2. Select “Vehicle Status Monitor”.
3. Select the applicable warning to view the warning details.

NOTE

You can also display the currently occurring warning by sliding the commander knob to the left while on the home screen of the centre display.

Multi-information display

1. Press the INFO switch on the steering switch to display the warning indication screen.
Refer to Multi-information Display on page 4-21.

▼ Brake System Warning Indication/Warning Light



This warning has the following functions:

Warning light inspection

For an operation check, make sure that the light turns on when the ignition is switched on, and turns off a few seconds later or when the engine is started.

When the light turns on

If the brake system warning light remains illuminated the brake fluid may be low or there could be a problem with the brake system. Park the vehicle in a safe place immediately and contact an expert repairer, we recommend an Authorised Mazda Repairer.

Refer to Inspecting Brake/Clutch Fluid Level on page 6-16.



Do not drive with the brake system warning light illuminated. Contact an expert repairer, we recommend an Authorised Mazda Repairer to have the brakes inspected as soon as possible:

Driving with the brake system warning light illuminated is dangerous. It indicates that your brakes may not work at all or that they could completely fail at any time. If this light remains illuminated, after checking that the parking brake is fully released, have the brakes inspected immediately.

If Trouble Arises

Warning/Indicator Lights and Warning Sounds

CAUTION

➤ In addition, the effectiveness of the braking may diminish so you may need to depress the brake pedal more strongly than normal to stop the vehicle.

▼ Electronic Brake Force Distribution System Warning



If the electronic brake force distribution control unit determines that some components are operating incorrectly, the control unit may illuminate the brake system warning light and the ABS warning light simultaneously. The problem is likely to be the electronic brake force distribution system.

WARNING

Do not drive with both the brake system warning light and ABS warning light illuminated. Have the vehicle towed to an expert repairer, we recommend an Authorised Mazda Repairer to have the brakes inspected as soon as possible:

Driving when the brake system warning light and ABS warning light are illuminated simultaneously is dangerous. When both lights are illuminated, the rear wheels could lock more quickly in an emergency stop than under normal circumstances.

▼ Charging System Warning Indication/Warning Light



If the warning light illuminates while driving, it indicates a malfunction of the alternator or of the charging system. Drive to the side of the road and park off the right-of-way. Consult an expert repairer, we recommend an Authorised Mazda Repairer.

CAUTION

Do not continue driving when the charging system warning light is illuminated because the engine could stop unexpectedly.

▼ Engine Oil Warning Indication/Warning Light



This warning light indicates low engine oil pressure.

CAUTION

Do not run the engine if the oil pressure is low. Otherwise, it could result in extensive engine damage.

If the light illuminates or the warning indication is displayed while driving:

1. Drive to the side of the road and park off the right-of-way on level ground.

Warning/Indicator Lights and Warning Sounds

2. Turn off the engine and wait 5 minutes for the oil to drain back into the sump.
3. Inspect the engine oil level (page 6-14). If it's low, add the appropriate amount of engine oil while being careful not to overfill.



Do not run the engine if the oil level is low. Otherwise, it could result in extensive engine damage.

4. Start the engine and check the warning light.

If the light remains illuminated even though the oil level is normal or after adding oil, stop the engine immediately and have your vehicle towed to an expert repairer, we recommend an Authorised Mazda Repairer.

▼ High Engine Coolant Temperature Warning Indication



Displays if the engine coolant temperature has increased excessively.

“Elevated Engine Coolant Temp. Drive Slowly” displayed

Drive slowly to reduce engine load until you can find a safe place to stop the vehicle and wait for the engine to cool down.

“Excessive Engine Coolant Temp. Stop the Vehicle in a Safe Location” displayed

This indicates the possibility of overheating. Park the vehicle in a safe place immediately and stop the engine. Refer to Overheating on page 7-17.



Do not drive the vehicle with the high engine coolant temperature warning light illuminated. Otherwise, it could result in damage to the engine.

▼ Power Steering Malfunction Indication/Indicator Light



The message is displayed if the electric power steering has a malfunction. If the message is displayed, stop the vehicle in a safe place and do not operate the steering wheel. There is no problem if the message in the display turns off after a while. Contact an expert repairer, we recommend an Authorised Mazda Repairer if the message is displayed continuously.

NOTE

· If the message is displayed, the power steering will not operate normally. In this case, the steering wheel can still be operated, however, the operation may feel heavy compared to normal, or the steering wheel could vibrate when turning.

If Trouble Arises

Warning/Indicator Lights and Warning Sounds

· Repeatedly jerking the steering wheel left and right while the vehicle is stopped or moving extremely slowly will cause the power steering system to go into protective mode which will make the steering feel heavy, but this does not indicate a problem. If this occurs, park the vehicle safely and wait several minutes for the system to return to normal.

▼ ABS Warning Indication/Warning Light



If the ABS warning light stays on while you're driving, the ABS control unit has detected a system malfunction. If this occurs, your brakes will function normally as if the vehicle had no ABS.

Should this happen, consult an expert repairer, we recommend an Authorised Mazda Repairer as soon as possible.

NOTE

- When the engine is jump-started to charge the battery, uneven rpm occurs and the ABS warning light may illuminate. If this occurs, it is the result of the weak battery and does not indicate an ABS malfunction. Recharge the battery.
- The brake assist system does not operate while the ABS warning light is illuminated.

▼ Master Warning Indication



The indication displays if the system has a malfunction.

Check the reason for the indication displaying on the centre display or multi-information display.

Refer to If a Warning Light Turns On or Flashes on page 7-23.

▼ Brake Control System Warning Indication/Warning Light



The warning light illuminates when the system has a malfunction. Have your vehicle inspected at an expert repairer, we recommend an Authorised Mazda Repairer.

▼ Electric Parking Brake (EPB) Indication/Indicator Light



This warning has the following functions:

Parking brake warning/Indicator light inspection

The light illuminates when the parking brake is applied with the ignition switched to START or ON. It turns off when the parking brake is released.

Warning/Indicator Lights and Warning Sounds

When the light is flashing

The light flashes if the Electric Parking Brake (EPB) has a malfunction. If the light remains flashing even if the Electric Parking Brake (EPB) switch is operated, consult an expert repairer, we recommend an Authorised Mazda Repairer as soon as possible.

▼ Brake Override Warning Indication



This message is displayed when the accelerator pedal and brake pedal are depressed at the same time while driving.

Action to be taken

Release the accelerator pedal and depress the brake pedal.

▼ Check Engine Indication/Light



If this light illuminates while driving, the vehicle may have a problem. It is important to note the driving conditions when the light illuminated and consult an expert repairer, we recommend an Authorised Mazda Repairer.

The check engine light may illuminate in the following cases:

- The engine's electrical system has a problem.
- The emission control system has a problem.
- The fuel tank level being very low or approaching empty.

- The fuel-filler cap is missing or not tightened securely.

If the check engine light remains on, or it flashes continuously, do not drive at high speeds and consult an expert repairer, we recommend an Authorised Mazda Repairer as soon as possible.

⚠ WARNING

If the check engine light turns on, do not disconnect the battery leads.

If the battery leads are disconnected and then reconnected, the engine could be damaged and catch on fire.

▼ i-stop Warning Light

i-stop

When the light is turned on

A problem in the system may be indicated under the following conditions. Have your vehicle inspected at an expert repairer, we recommend an Authorised Mazda Repairer.

- The light does not turn on when the ignition is switched ON.

When the light is flashing

The light continues to flash if the system has a malfunction. Have your vehicle inspected at an expert repairer, we recommend an Authorised Mazda Repairer.

Warning/Indicator Lights and Warning Sounds

▼ Automatic Transmission Warning Indication/Warning Light*

AT

The indication/light illuminates when the transmission has a problem.



If the automatic transmission warning indication/light illuminates, the transmission has an electrical problem. Continuing to drive your Mazda in this condition could cause damage to your transmission. Consult an expert repairer, we recommend an Authorised Mazda Repairer as soon as possible.

▼ TCS/DSC Indication/Indicator Light (Turns on)



If the light stays on, the TCS, DSC or the brake assist system may have a malfunction and they may not operate correctly. Take your vehicle to an expert repairer, we recommend an Authorised Mazda Repairer.

▼ Air Bag/Front Seat Belt Pretensioner System Warning Indication/Warning Light



A system malfunction is indicated if the warning light constantly flashes, constantly illuminates or does not illuminate at all when the ignition is switched ON. If any of these occur, consult an expert repairer, we recommend an Authorised Mazda Repairer as soon as possible. The system may not operate in an accident.



Never tamper with the air bag/pretensioner systems and always have an expert repairer, we recommend an Authorised Mazda Repairer perform all servicing and repairs:

Self-servicing or tampering with the systems is dangerous. An air bag/pretensioner could accidentally activate or become disabled causing serious injury or death.

Warning/Indicator Lights and Warning Sounds

▼ Tyre Pressure Monitoring System (TPMS) Warning Indication/Warning Light (Flashing)



If there is a problem with the TPMS or the voltage of a tyre pressure sensor decreases, the TPMS warning light flashes and a message is displayed on the multi-information display. Have your vehicle inspected by an expert repairer, we recommend an Authorised Mazda Repairer.

! WARNING

Do not drive the vehicle at high speeds if the TPMS warning light turns on or flashes: Driving the vehicle at high speeds while the TPMS warning light is turned on or flashing is dangerous because the brake performance and the steering wheel operability will be reduced. If the vehicle is driven at high speeds or the brakes are suddenly applied, it could lead to an accident. Gradually apply the brakes to lower the vehicle's speed.

Do not ignore the TPMS warning light when it is turned on or flashing: Continuing to drive the vehicle while ignoring the illumination/flashing of the TPMS warning light is dangerous because a tyre may burst which could lead to an accident. Take appropriate measures as soon as possible.

▼ KEY Warning Indication/Warning Light (Red)



“Keyless Entry System Malfunc. Have the Vehicle Inspected” is displayed

This message is displayed if the advanced keyless entry & push button start system has a problem.

Contact an expert repairer, we recommend an Authorised Mazda Repairer.

! CAUTION

If the message is indicated, or the push button start indicator light (amber) flashes, the engine may not start. If the engine cannot be started, try starting it using the emergency operation for starting the engine, and have the vehicle inspected at an expert repairer, we recommend an Authorised Mazda Repairer as soon as possible.

Refer to Emergency Operation for Starting the Engine on page 4-10.

“Low Key Fob Battery. Replace Battery” is displayed

When the key battery is low, the indication is displayed when the ignition is switched OFF.

If Trouble Arises

Warning/Indicator Lights and Warning Sounds

“Key Not Detected” is displayed

- If the presence of the key cannot be detected (dead battery, battery malfunction, no key), it is displayed when the driver attempts to start the engine (push button start operation, brake pedal depression).
- Displayed when it is determined that a key that was in the vehicle has been removed from the vehicle. (Key taken out warning. Other than IG-OFF)

▼ Security Indicator Light



If the security indicator light flashes continuously while you are driving, do not shut off the engine. Go to an Authorised Mazda Repairer and have it checked. If the engine is shut off while the indicator light is flashing, you will not be able to restart it.

Make sure the key is within the operational range for signal transmission. Switch the ignition off, and then restart the engine. If the engine does not start after 3 or more tries, contact an Authorised Mazda Repairer.

NOTE

Because the electronic codes are reset when the immobilizer system is repaired, the keys are needed. Make sure to bring all the keys to an Authorised Mazda Repairer so that they can be programmed.

▼ High Beam Control System (HBC) Warning Indication/Warning Light (Amber)*



The light remains turned on if there is a problem with the system. Have your vehicle inspected at an expert repairer, we recommend an Authorised Mazda Repairer.

▼ Adaptive LED Headlights (ALH) Warning Indication/Warning Light (Amber)*



The light remains turned on if there is a problem with the system. Have your vehicle inspected at an expert repairer, we recommend an Authorised Mazda Repairer.

▼ i-ACTIVSENSE Warning Indication/Warning Light



The indication displays if the system has a malfunction.

Check the reason for the indication displaying on the centre display or multi-information display.

Refer to If a Warning Light Turns On or Flashes on page 7-23.

Warning/Indicator Lights and Warning Sounds

▼ Exterior Light Warning Indication/ Warning Light



This light illuminates if there is a malfunction in the exterior lights (except number plate lights). Have your vehicle inspected by an expert repairer, we recommend an Authorised Mazda Repairer.

▼ Low Fuel Warning Indication/ Warning Light



The light turns on when the remaining fuel is about 9.0 L (2.3 US gal, 1.9 Imp gal). If you continue to drive after the light turns on without refuelling and the fuel gauge reaches nearly empty, the light flashes.

NOTE

The light illumination timing may vary because fuel inside the fuel tank moves around according to the driving conditions and the vehicle posture.

Action to be taken

Add fuel. If the light is flashing, refuel as soon as possible.

▼ Engine Oil Level Warning Indication/Warning Light



This warning light indicates that the engine oil level is around the MIN mark (page 6-14).

Action to be taken

Add 1 L (0.3 US gal, 0.2 Imp gal) of engine oil (page 6-13).

▼ Seat Belt Warning Indication/ Warning Light (Front seat)



The seat belt warning light turns on if the driver or front passenger's seat is occupied and the seat belt is not fastened with the ignition switched ON.

If the driver or front passenger's seat belt is unfastened (only when the front passenger's seat is occupied) and the vehicle is driven at a speed faster than about 20 km/h (12 mph), the warning light flashes. After a short time, the warning light stops flashing, but remains illuminated. If a seat belt remains unfastened, the warning light flashes again for a given period of time.

NOTE

- If the driver or front passenger's seat belt is unfastened after the warning light turns on, and the vehicle speed exceeds 20 km/h (12 mph), the warning light flashes again.
- Placing heavy items on the front passenger's seat may cause the front passenger's seat belt warning function to operate depending on the weight of the item.

If Trouble Arises

Warning/Indicator Lights and Warning Sounds

- To allow the front passenger seat weight sensor to function properly, do not place and sit on an additional seat cushion on the front passenger's seat. The sensor may not function properly because the additional seat cushion could cause sensor interference.
- If a small child is seated on the front passenger's seat, the warning light may not operate.

Action to be taken

Fasten the seat belts.

▼ Seat Belt Warning Light (Rear seat) (Red)



If the rear seat belts are not fastened while the ignition is switched ON, the driver and the passenger are alerted by the warning light.

The warning light operates even if there is no passenger on the rear seat.

NOTE

If a rear seat belt is not fastened by a certain period of time after the engine has been started, the warning light turns off.

Action to be taken

Fasten the seat belts.

▼ Door-Ajar/Boot lid-Ajar/ Liftgate-Ajar Warning Indication/ Warning Light

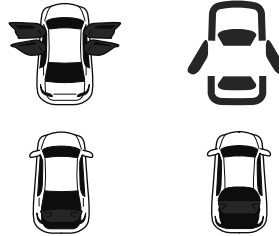

The light turns on if any door/boot lid/liftgate is not closed securely.

Action to be taken

Close the door/boot lid/liftgate securely.

▼ Tyre Pressure Monitoring System (TPMS) Warning Indication/ Warning Light (Turns on)



If a tyre pressure decreases below the specified air pressure, the TPMS warning light turns on.

At the same time, a message and the tyre pressure of each tyre are displayed on the multi-information display alternately. In addition, the tyre (s) with low air pressure is displayed in yellow.

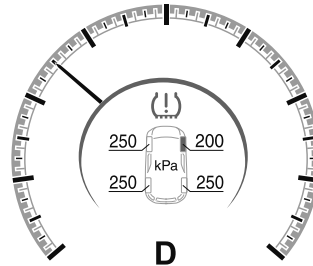

Warning/Indicator Lights and Warning Sounds

WARNING

Do not drive the vehicle at high speeds if the TPMS warning light turns on or flashes: Driving the vehicle at high speeds while the TPMS warning light is turned on or flashing is dangerous because the brake performance and the steering wheel operability will be reduced. If the vehicle is driven at high speeds or the brakes are suddenly applied, it could lead to an accident. Gradually apply the brakes to lower the vehicle's speed.

Do not ignore the TPMS warning light when it is turned on or flashing: Continuing to drive the vehicle while ignoring the illumination/flashing of the TPMS warning light is dangerous because a tyre may burst which could lead to an accident. Take appropriate measures as soon as possible.

NOTE

While the TPMS is learning the tyre positions, such as immediately after a tyre position has been changed, the tyre pressure at the tyre position prior to it being changed is displayed until the system completes the learning. For this reason, the tyre pressures displayed for the tyre positions may be different from the actual tyre pressures at the tyre positions.

Action to be taken

Adjust the tyre pressures to the appropriate pressures.
Refer to Tyre Inflation Pressure on page 6-28.

CAUTION

- Adjust the tyre pressures while the tyres are cool. Because the air pressure in the tyres fluctuates depending on the temperature, before adjusting the tyre pressures, let the vehicle sit for an hour or drive it only within a 1.6 km (1 mile) distance. If the tyre pressures are adjusted while the tyres are warm, the tyre pressures may decrease below the specified air pressure after cooling down which could turn on the warning light. In addition, because the air pressure in the tyres decreases when the ambient temperature is low, if the ambient temperature increases, an illuminated TPMS warning light may turn off. Under any circumstances, always adjust the tyre pressures while the tyres are cool.
- After adjusting the tyre pressures, the TPMS warning light turns off. If the TPMS warning light does not turn off, drive the vehicle at a speed of about 25 km (16 mph) or faster for 3 minutes or longer and make sure the warning light turns off.

If the TPMS warning light remains on even after adjusting the tyre pressures, one of the tyres may have a puncture. Refer to Changing a Flat Tyre on page 7-7.

If Trouble Arises

Warning/Indicator Lights and Warning Sounds

Message Indicated on Multi-information Display

▼ Message Indicated on Multi-information Display

If there is a notification from the vehicle, a message is displayed on the multi-information display. Check the information and take the necessary action.

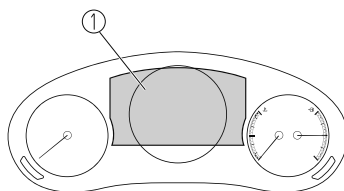

1. Multi-information display

If the warning light turns on/flashes simultaneously or a symbol is indicated on the display, check the information regarding the warning light or symbol. Refer to If a Warning Light Turns On or Flashes on page 7-23.

Display*1*2	Content	Action to be taken
Depress Brake Pedal. Brake Hold Disabled	This message is indicated when there is a problem with the brake related system while the vehicle is being held in a stop position by the AUTOHOLD function.	Depress the brake pedal. Cancel the AUTOHOLD function and have your vehicle inspected at an expert repairer, we recommend an Authorised Mazda Repairer.
Steep Slope. Continue Pressing Brake Pedal to Hold Stopped Position	This message indicates the possibility of the vehicle not being held in the stopped position by the AUTOHOLD function, such as on steep slopes.	Depress and hold your foot on the brake pedal.
Depress Brake Pedal and Operate Switch to Release EPB	This message is indicated when the Electric Parking Brake (EPB) switch is operated without depressing the brake pedal.	Operate the Electric Parking Brake (EPB) switch while depressing the brake pedal.
Depress Brake Pedal and Operate Switch to Release	This message is indicated when the cancel operation is done without depressing the brake pedal while the vehicle is being held in the stopped position by the AUTOHOLD function.	Cancel the AUTOHOLD function stop hold control while depressing the brake pedal.
Mazda Radar Cruise Control Cancelled. Drive Safely	This message is indicated when the Mazda Radar Cruise Control (MRCC), Mazda Radar Cruise Control with Stop & Go function (MRCC with Stop & Go function), and the Cruising & Traffic Support (CTS) have been cancelled other than by the driver.	Have your vehicle inspected by an expert repairer, we recommend an Authorised Mazda Repairer.

Warning/Indicator Lights and Warning Sounds

Display ^{*1*2}	Content	Action to be taken
Distance & Speed Alert Operation Cancelled Drive Safely	This message is indicated when the Distance & Speed Alert (DSA) have been cancelled other than by the driver.	Have your vehicle inspected by an expert repairer, we recommend an Authorised Mazda Repairer.
Cruise Control Operation Cancelled. Drive Safely	This message is indicated when the Cruise Control have been cancelled other than by the driver.	Have your vehicle inspected by an expert repairer, we recommend an Authorised Mazda Repairer.
Emergency Braking Activated. Depress Brake Pedal to Hold Stop	This message is indicated after the Smart Brake Support (SBS) brakes operate and when the Smart Brake Support (SBS) is cancelled.	Depress the brake pedal.
Engine Stopped. Restart Engine Normally	This message is indicated when a seat belt is unfastened and the driver's door is opened while the i-stop function is operating.	Press the push button start again to start the engine. For automatic transmission vehicles, shift the selector lever to the P position before starting the engine.)
Continue to Depress Brake Pedal While i-stop Is Active	This message is indicated when the driver's door is opened while the i-stop function is operating.	Depress the brake pedal. Stop the engine before leaving the vehicle.
Touch Key Fob to Push Button Start Switch	This message is indicated when the key battery is weak (battery dead or damaged key).	Touch the key against push button start to start the engine. Refer to Engine Start Function When Key Battery is Dead on page 4-8.
Depress Brake Pedal to Start Engine	This message is indicated when the push button start is pressed without depressing the brake pedal.	Depress the brake pedal and press the push button start.
Depress Clutch Pedal to Start Engine	This message is indicated when the push button start is pressed without depressing the clutch pedal.	Depress the clutch pedal and press the push button start.
Press Push Button Start Switch While Turning Steering Wheel Left or Right	This message is indicated while the steering wheel is locked.	Release the steering lock.
Check Gear Selector Lever Position	This message is indicated when the selector lever is shifted to the P or R position while driving.	Check the selector lever position.
Close Door and Fasten Seat Belt	This message is indicated when AUTOHOLD is about to operate and a door is opened or a seat belt is unfastened.	When the AUTOHOLD is turned on, close the doors and fasten seat belts.
Wiper Blades Must Be on Windscreen Before Operating	This message is indicated when the windscreen wipers are operated with the wipers raised off the windscreen.	Lower the windscreen wipers.
Windscreen Wiper Range of Motion Reduced. Remove Obstruction(s)	This message is indicated when there is snow or dirt accumulation on the windscreen and the wiper operation range is narrowed.	Remove foreign matter from the windscreen.

If Trouble Arises

Warning/Indicator Lights and Warning Sounds

Display*1*2	Content	Action to be taken
Ignition Not Switched Off	This message is indicated when the driver's door is opened without switching the ignition OFF.	Switch the ignition OFF before leaving the vehicle.
Gear Selector Lever Not in Park	This message is indicated when a door is opened with the selector lever in a position other than the P position.	Shift the selector lever to the P position before leaving the vehicle.
Excessive Transmission Temperature. Drive Slowly	This message is indicated when the internal temperature of the automatic transmission is high.	Drive slowly to reduce load on the automatic transmission.
Excessive Transmission Temperature. Stop Vehicle in a safe Location	This message is indicated when the automatic transmission fluid temperature is abnormally high.	Park the vehicle in a safe place immediately and contact an expert repairer, we recommend an Authorised Mazda Repairer.

*1 A pop-up is displayed when a warning occurs.

*2 One screen displays four rows. If the entire message cannot be displayed on the screen, it switches to another screen.

Warning/Indicator Lights and Warning Sounds

Warning Sound is Activated

▼ Lights-On Reminder

If lights are on and the ignition is switched to ACC or off, a continuous beep sound will be heard when the driver's door is opened.

NOTE

- When the ignition is switched to ACC, the "Ignition Not Switched Off (STOP) Warning Beep" (page 7-38) overrides the lights-on reminder.
- A personalised function is available to change the sound volume for the lights-on reminder.
Refer to the Settings section in the MZD Connect Owner's Manual.

▼ Air Bag/Front Seat Belt Pretensioner System Warning Beep

If there is a problem with the air bag/front seat belt pretensioner systems and the warning light illumination, a warning beep sound will be heard for about 5 seconds every minute.

The air bag and front seat belt pretensioner system warning beep sound will continue to be heard for approximately 35 minutes. Have your vehicle inspected at an expert repairer, we recommend an Authorised Mazda Repairer as soon as possible.

WARNING

Do not drive the vehicle with the air bag/front seat belt pretensioner system warning beep sounding:

Driving the vehicle with the air bag/front seat belt pretensioner system warning beep sounding is dangerous. In a collision, the air bags and the front seat belt pretensioner system will not deploy and this could result in death or serious injury. Contact an expert repairer, we recommend an Authorised Mazda Repairer to have the vehicle inspected as soon as possible.

▼ Seat Belt Warning Beep

Front seat

If the vehicle speed exceeds about 20 km/h (12 mph) with the driver or front passenger's seat belt unfastened, a warning beep sounds continuously. If the seat belt remains unfastened, the beep sound stops once and then continues for about 90 seconds. The beep stops after the driver or front passenger's seat belt is fastened.

NOTE

- Placing heavy items on the front passenger seat may cause the front passenger seat belt warning function to operate depending on the weight of the item.
- To allow the front passenger seat weight sensor to function properly, do not place and sit on an additional seat cushion on the front passenger seat. The sensor may not function properly because the additional seat cushion could cause sensor interference.

Warning/Indicator Lights and Warning Sounds

· When a small child sits on the front passenger seat, it is possible that the warning beep will not operate.

Rear seat

The warning beep only sounds if a seat belt is unfastened after being fastened.

▼ Ignition Not Switched Off (STOP) Warning Beep

If the driver's door is opened with the ignition switched to ACC, a beep will be heard continuously in the cabin to notify the driver that the ignition has not been switched OFF (STOP). Under this condition, the keyless entry system will not operate, the vehicle cannot be locked, and the battery voltage will be depleted.

▼ Key Removed from Vehicle Warning Beep

Vehicles with advanced keyless function

If the key is taken out of the vehicle while the ignition is not switched OFF and all the doors are closed, the beep which sounds outside of the vehicle will be heard 6 times, and after that, the beep which sounds inside the vehicle will be heard 1 times.

Vehicles without advanced keyless function

If the key is taken out of the vehicle while the ignition is not switched OFF and all the doors are closed, a beep will be heard in the cabin 1 times.

NOTE

Because the key utilizes low-intensity radio waves, the Key Removed From Vehicle Warning may activate if the key is carried together with a metal object or it is placed in a poor signal reception area.

▼ Touch Sensor Inoperable Warning Beep (With the advanced keyless function)

A warning beep is activated to notify the driver that the doors are not locked when all of the following conditions are met:

- The ignition is switched OFF.
- All the doors and liftgate/boot lid are not fully closed.
- The lock is operated 3 times within 5 seconds.

Check the ignition and whether the doors and liftgate/boot lid are open or closed, and then operate the lock again.

▼ Key Left-in-luggage Compartment/ Boot Warning Beep (With the advanced keyless function)

If the key is left in the luggage compartment/boot with all the doors locked and the liftgate/boot lid closed, a beep will be heard outside for about 10 seconds to notify the driver that the key is in the luggage compartment/boot. In this case, take out the key by pressing the electric liftgate/boot lid opener and opening the liftgate/boot lid. The key taken out of the luggage compartment/boot may not operate because its functions have been temporarily stopped. To restore the key's functions, perform the applicable procedure (page 3-7).

Warning/Indicator Lights and Warning Sounds

▼ Key Left-in-vehicle Warning Beep (With the advanced keyless function)

If all the doors and luggage compartment/boot are locked using another key while the key is left in the cabin, the beep which sounds outside of the vehicle will be heard for about 10 seconds to notify the driver that the key is in the cabin. In this case, take out the key by opening the door. A key taken out of the vehicle using this method may not operate because its functions have been temporarily stopped. To restore the key's functions, perform the applicable procedure (page 3-7).

▼ Low Fuel Warning Beep

When the low fuel warning light flashes, a warning beep is activated once at the same time.

▼ Electronic Steering Lock Warning Beep

The warning beep operates if the steering wheel is not unlocked after the push button start is pressed. (page 4-4)

▼ Brake Override Warning Beep

A warning beep is activated when the accelerator pedal and brake pedal are depressed at the same time while driving. Only depress the brake pedal.

▼ Vehicle Problem Warning Beep

If any of the following problems occur, a warning beep is activated. Check the information regarding the warning indication in the instrument cluster or on the centre display.

- Automatic transmission problem
- Increase in automatic transmission internal temperature
- Brake fluid amount decrease
- Engine oil level sensor problem
- Electric Parking Brake (EPB) problem
- Engine hydraulic pressure decrease
- Engine coolant temperature increase
- Engine system problem

▼ i-stop Warning Beep

- If the driver's door is opened while engine idling is stopped, the warning sound operates to notify the driver that engine idling is stopped. It stops when the driver's door is closed.

▼ Electric Parking Brake (EPB) Warning Beep

The warning buzzer is activated under the following conditions:

- The vehicle is driven with the parking brake applied.
- The Electric Parking Brake (EPB) switch is pulled while the vehicle is driven.
- You attempt to start driving the vehicle while the conditions for releasing the Electric Parking Brake (EPB) automatically have not been met.

If Trouble Arises

Warning/Indicator Lights and Warning Sounds

▼ AUTOHOLD Warning Beep

Message is displayed and beep sound is activated simultaneously for about 5 seconds when using AUTOHOLD function or when AUTOHOLD switch is operated.

Because a problem with AUTOHOLD function has occurred, AUTOHOLD function does not operate even if AUTOHOLD switch is operated.

If the message is displayed and the beep sound is activated simultaneously, have your vehicle inspected at an expert repairer, we recommend an Authorised Mazda Repairer.

▼ Vehicle Speed Alarm

The vehicle speed alarm function is designed to alarm the driver via a single beep sound and a warning indication in the instrument cluster that the previously set vehicle speed has been exceeded. You can change the vehicle speed setting at which the warning is triggered.

▼ Blind Spot Monitoring (BSM) Warning Beep

Driving forward

The warning beep operates when the direction indicator lever is operated to the side where the Blind Spot Monitoring (BSM) warning light is illuminated.

NOTE

A personalised function is available to change the Blind Spot Monitoring (BSM) warning beep sound volume. Refer to the Settings section in the MZD Connect Owner's Manual.

Reversing

The Blind Spot Monitoring (BSM) warning sound is activated if there is a possibility of collision with a vehicle approaching from behind and from the rear on the left and right sides of the vehicle.

▼ Lane Departure Warning Sound

While the system is operating, if the system determines that the vehicle may depart from the lane, it sounds a warning sound.

NOTE

The volume of the Lane Departure Warning System (LDWS) warning sound can be changed.

Refer to the Settings section in the MZD Connect Owner's Manual.

▼ Mazda Radar Cruise Control (MRCC) System Warnings*

The Mazda Radar Cruise Control (MRCC) system warnings notify the driver of system malfunctions and cautions on use when required. Check based on the beep sound.

Warning beep	What to check
The beep sounds 1 time while the Mazda Radar Cruise Control (MRCC) is operating	The vehicle speed is slower than 25 km/h (16 mph) and the Mazda Radar Cruise Control (MRCC) system has been cancelled.
The beep sounds continuously while driving	The distance between your vehicle and the vehicle ahead is too close. Verify the safety of the surrounding area and reduce vehicle speed.

Warning/Indicator Lights and Warning Sounds

▼ Mazda Radar Cruise Control with Stop & Go function (MRCC with Stop & Go function) System Warnings*

The Mazda Radar Cruise Control with Stop & Go function (MRCC with Stop & Go function) system warnings notify the driver of system problems and precautions on use when required. Check after hearing a warning beep sound.

Warning beep	What to check
The beep sounds intermittently while the vehicle is being driven.	The distance between your vehicle and the vehicle ahead is too close. Verify the safety of the surrounding area and reduce vehicle speed.

▼ Excessive Speed Warning

If the vehicle speed exceeds the speed limit sign displayed in the active driving display/instrument cluster, the area around the speed limit sign flashes in amber and the warning sound is activated at the same time. If the vehicle speed continues to exceed the displayed speed limit sign, the indication stops flashing and remains on.

▼ Speed Limiter Warning Beep

If the vehicle speed exceeds the set speed by about 5 km/h (3 mph) or more, a warning beep operates continuously. The warning beep operates until the vehicle speed decreases to the set speed or less.

CAUTION

If the set speed is set lower than the current vehicle speed by pressing the SET- or RES switch, the warning beep is not activated for about 30 seconds even if the vehicle speed is faster than the newly set speed by 5 km/h (3 mph). Be careful not to drive over the set speed.

NOTE

When the system is temporarily cancelled by depressing the accelerator pedal fully, the ISA display shows the cancel display. If the vehicle speed exceeds the set speed by about 5 km/h (3 mph) or more while the cancel display is displayed, the set speed display flashes but the warning sound is not operated.

▼ Collision warning

If there is a possibility of a collision with a vehicle ahead or an obstruction at the rear of the vehicle, a warning sound is activated intermittently at the same time as the warning indications are displayed in the instrument cluster or active driving display.

▼ Door-ajar Warning Beep

A warning beep is activated if the vehicle is driven with a door ajar. Drive the vehicle after closing the doors.

*Some models.

If Trouble Arises

When Liftgate/Boot Lid Cannot be Opened

When Liftgate/Boot Lid Cannot be Opened

▼ When Liftgate/Boot Lid Cannot be Opened

If the battery is dead, the liftgate/boot lid cannot be unlocked and opened.

In this case, the liftgate/boot lid can be unlocked by taking care of the dead battery situation.

Refer to Jump-Starting on page 7-13.

If the liftgate/boot lid cannot be unlocked even if the dead battery situation has been resolved, the electrical system may have a malfunction.

In this case, the liftgate/boot lid can be opened using the following procedure as an emergency measure.

(Hatchback)

1. Wrap the end of a flathead screwdriver in a cloth and remove the cap on the interior surface of the liftgate using it.

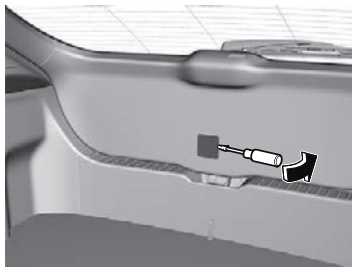

2. Turn the lever to the right to unlock the liftgate.

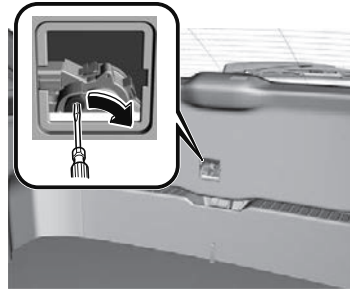

(Saloon)

1. Open the cover.

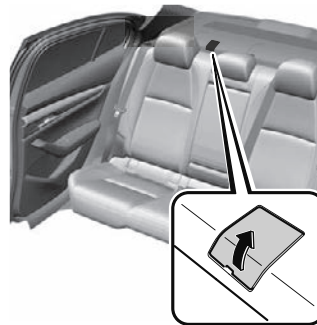

2. Move the lever to the left to fold the seatback.

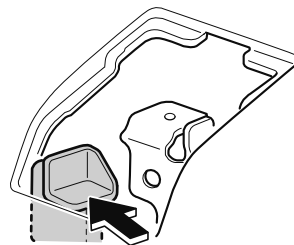

When Liftgate/Boot Lid Cannot be Opened

3. Move the lever to the left to open the boot lid.

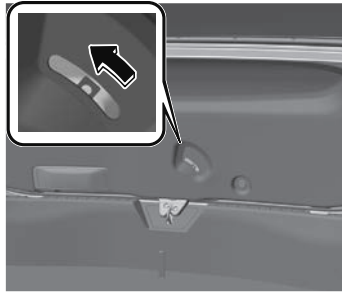

After performing this emergency measure, have the vehicle inspected at an expert repairer, we recommend an Authorised Mazda Repairer as soon as possible.

If Trouble Arises

Active Driving Display Does Not Operate

If the Active Driving Display Does Not Operate

▼ If the Active Driving Display Does Not Operate

If the active driving display does not operate, switch the ignition off and then restart the engine. If the active driving display does not operate even with the engine restarted, have the vehicle inspected at an expert repairer, we recommend an Authorised Mazda Repairer.

Windscreen Wipers Operate at High Speed

Windscreen Wipers Operate at High Speed

▼ Windscreen Wipers Operate at High Speed

The windscreen wipers may operate at high speed if there is a problem with the wiper control. If the windscreen wipers operate at high speed regardless of the wiper switch operation, have your vehicle inspected by an expert repairer, we recommend an Authorised Mazda Repairer.

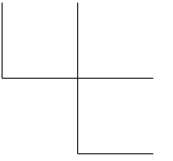
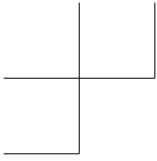

MEMO

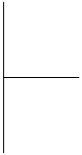

7-46

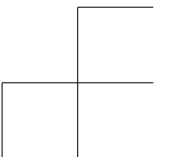
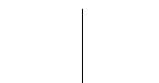
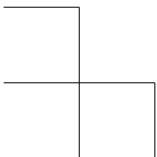

8

Customer Information

Important consumer information including warranties and add-on equipment.

Warranty.....	8-2	Recording of Vehicle Data.....	8-5
Registering Your Vehicle in A		Recording of Vehicle Data.....	8-5
Foreign Country.....	8-2	Declaration of Conformity.....	8-6
Add-On Non-Genuine Parts and		Declaration of Conformity.....	8-6
Accessories.....	8-2		
Cell Phones.....	8-4		
Cell Phones Warning.....	8-4		

Warranty

Registering Your Vehicle in A Foreign Country

▼ Registering Your Vehicle in A Foreign Country

Registering your vehicle in a foreign country may be problematic depending on whether it meets the specific emission and safety standards of the country in which the vehicle will be driven. Consequently, your vehicle may require modifications at personal expense in order to meet the regulations.

In addition, you should be aware of the following issues:

Satisfactory vehicle servicing may be difficult or impossible in another country.

The fuel specified for your vehicle may be unavailable.

Parts, servicing techniques, and tools necessary to maintain and repair your vehicle may be unavailable.

There might not be an Authorised Mazda Dealer in the country you plan to take your vehicle.

The Mazda warranty is valid only in certain countries.

Add-On Non-Genuine Parts and Accessories

▼ Add-On Non-Genuine Parts and Accessories

Please note that technical alterations to the original state of your Mazda vehicle can affect the safety of the vehicle. Such technical alterations include not only the use of unsuitable spare parts, but also accessories, fittings or attachments, including rims and tyres.

Genuine Mazda Parts and Genuine Mazda Accessories have been specifically designed for Mazda vehicles.

Other parts and accessories than those mentioned above have not been examined and approved by Mazda unless explicitly stated by Mazda. We cannot certify the suitability of such products. Mazda is not liable for any damage caused by the use of such products.

WARNING

Be very careful in choosing and installing add-on electrical equipment, such as mobile telephones, two-way radios, stereo systems, and car alarm systems:

Incorrectly choosing or installing improper add-on equipment or choosing an improper installer is dangerous. Essential systems could be damaged, causing engine stalling, air-bag (SRS) activation, ABS/TCS/DSC inactivation, or a fire in the vehicle.

Warranty

Mazda assumes no responsibility for death, injury, or expenses that may result from the installation of add-on non-genuine parts or accessories.

Cell Phones

Cell Phones Warning

▼ Cell Phones Warning



Please comply with the legal regulations concerning the use of communication equipment in vehicles in your country:
Use of any electrical devices such as cell phones, computers, portable radios, vehicle navigation or other devices by the driver while the vehicle is moving is dangerous. Dialing a number on a cell phone while driving also ties-up the driver's hands. Use of these devices will cause the driver to be distracted and could lead to a serious accident. If a passenger is unable to use the device, pull off the right-of-way to a safe area before use. If use of a cell phone is necessary despite this warning, use a hands-free system to at least leave the hands free to drive the vehicle. Never use a cell phone or other electrical devices while the vehicle is moving and, instead, concentrate on the full-time job of driving.

Recording of Vehicle Data

Recording of Vehicle Data

▼ Recording of Vehicle Data

This vehicle is equipped with a computer which records the following main vehicle data related to vehicle controls, operation, and other driving conditions.

Recorded data

- Vehicle conditions such as engine speed and vehicle speed
- Driving operation conditions such as accelerator and brake pedals, and information related to the environmental circumstances while the vehicle is driven
- Malfunction diagnosis information from each on-vehicle computer
- Information related to controls of other on-vehicle computers

NOTE

The recorded data may vary depending on the vehicle grade and optional equipment. Voice and images are not recorded.

Data handling

Mazda and its subcontracting parties may obtain and use the recorded data for vehicle malfunction diagnosis, research and development, and quality improvement.

Mazda will not disclose or provide any of the obtained data to a third party unless:

- An agreement from the vehicle owner (agreements from lessor and lessee for leased vehicle) is obtained

- Officially requested by the police or other law enforcement authorities

Customer Information

Declaration of Conformity

Declaration of Conformity

▼ ADC Automotive Distance Control Systems GmbH SRR3-A



▼ ADC Automotive Distance Control Systems GmbH ARS4-B



▼ Tyre Pressure Monitoring System



8-6

9

Specifications

Technical information about your Mazda.

Identification Numbers.....	9-2	Specifications.....	9-3
Vehicle Information Labels.....	9-2	Specifications.....	9-3

Identification Numbers

Vehicle Information Labels

▼ Model Plate



▼ Chassis Number/Vehicle Identification Number

Open the cover shown in the figure to check the chassis number.

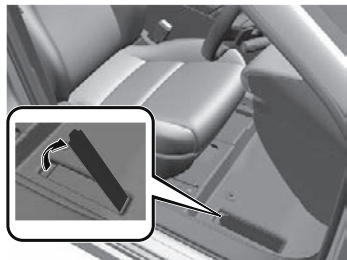

▼ Tyre Pressure Label



▼ Engine Number

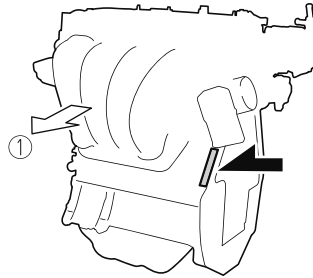

1. Forward

▼ Built Date (Australia)

The “Built Date” is the calendar month and the year in which the body shell and power train sub-assemblies are conjoined and the vehicle is driven or moved from the production line.

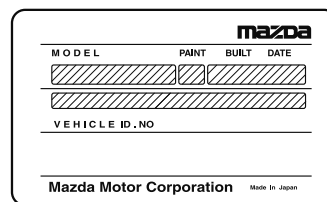

Specifications

▼ Engine

Item	Specification	
	SKYACTIV-G 2.0	SKYACTIV-G 2.5
Type	DOHC-16V in-line, 4-cylinder	
Bore × Stroke	83.5 × 91.2 mm (3.29 × 3.59 in)	89.0 × 100 mm (3.50 × 3.94 in)
Displacement	1,998 ml (1,998 cc)	2,488 ml (2,488 cc)
Compression ratio	13.0	

▼ Electrical System

Item	Classification	
Battery	Q-85*1	
Spark-plug number	Mazda Genuine spark plug*2	PE5R-18-110 or PE5S-18-110

- *1 Q-85 is designed for i-stop system (FOR STOP & START). Only Q-85 should be used to ensure correct operation of i-stop system (FOR STOP & START). Consult an expert repairer, we recommend an Authorised Mazda Repairer for details.
- *2 This spark plug provides the SKYACTIV-G engine with optimum performance. Contact an expert repairer, we recommend an Authorised Mazda Repairer for details.

CAUTION

When cleaning the iridium plugs, do not use a wire brush. The fine particulate coating on the iridium alloy and platinum tips could be damaged.

Specifications

Specifications

▼ Lubricant Quality

Lubricant	Classification	
	Australia	New Zealand
Engine oil*1	API SL/SM/SN or ILSAC GF-III/ GF-IV/GF-V	API SN or higher, or ILSAC GF-V or higher

*1 Refer to the recommended SAE viscosity numbers on page 6-13.

Lubricant	Classification
Coolant	FL-22 type
Manual transmission oil	Mazda Long Life Gear Oil G7*1
Automatic transmission fluid	Mazda Genuine special fluid (ATF FZ)
Brake fluid	SAE J1703 or FMVSS116 DOT-3

*1 Mazda Long Life Gear Oil G7 is superior oil for low fuel cost and optimum shift-feel. Using Mazda Long Life Gear Oil G7 is recommended.
If Mazda Long Life Gear Oil G7 cannot be obtained, use standard oil (API Service GL-4 (SAE 75W-80)).

▼ Capacities

(Approximate Quantities)

Item		Capacity	
Engine oil	SKYACTIV-G 2.0	With oil filter replacement	4.2 L (4.4 US qt, 3.7 Imp qt)
		Without oil filter replacement	4.0 L (4.2 US qt, 3.5 Imp qt)
	SKYACTIV-G 2.5	With oil filter replacement	4.5 L (4.8 US qt, 4.0 Imp qt)
		Without oil filter replacement	4.3 L (4.5 US qt, 3.8 Imp qt)
Coolant	Manual transmission		6.2 L (6.6 US qt, 5.5 Imp qt)
	Automatic transmission	SKYACTIV-G 2.0	6.4 L (6.8 US qt, 5.6 Imp qt)
		SKYACTIV-G 2.5	6.5 L (6.9 US qt, 5.7 Imp qt)
Manual transmission oil	SKYACTIV-G 2.0		1.70 L (1.80 US qt, 1.50 Imp qt)
	SKYACTIV-G 2.5		1.65 L (1.74 US qt, 1.45 Imp qt)
Automatic transmission fluid	SKYACTIV-G 2.0		7.6 L (8.0 US qt, 6.7 Imp qt)
	SKYACTIV-G 2.5		7.9 L (8.3 US qt, 7.0 Imp qt)
Fuel tank		51.0 L (13.5 US gal, 11.2 Imp gal)	

Check oil and fluid levels with dipsticks or reservoir gauges.

▼ **Dimensions**

Saloon

Item	Vehicle specification
Overall length	4,660 mm (183.5 in)
Overall width	1,795 mm (70.7 in)
Overall height	1,440 mm (56.7 in)
Front tread	1,570 mm (61.8 in)
Rear tread	1,580 mm (62.2 in)
Wheelbase	2,725 mm (107.3 in)

Hatchback

Item	Vehicle specification
Overall length	4,460 mm (175.6 in)
Overall width	1,795 mm (70.7 in)
Overall height	1,435 mm (56.5 in)
Front tread	1,570 mm (61.8 in)
Rear tread	1,580 mm (62.2 in)
Wheelbase	2,725 mm (107.3 in)

▼ **Light Bulbs**

Exterior light

Light bulb		Category	
		Wattage	UN-R*1 (SAE)
Headlights		LED*2	— (—)
Running lights/Position lights	LED type	LED*2	— (—)
	Bulb type	21/5	W21/5W (7444)
<ul style="list-style-type: none"> • Front direction indicator lights • Side direction indicator lights • High-mount brake light • Rear direction indicator lights • Brake lights • Tail lights • Reverse lights • Number plate lights 		LED*2	— (—)

*1 UN-R stands for United Nations Regulation.

*2 LED is the abbreviation for Light Emitting Diode.

Specifications

Specifications

Interior light

Light bulb	Category	
	Wattage	UN-R*1
Overhead light (Front)/Map lights	LED*2	—
Overhead light (Rear)	LED*2	—
Vanity mirror lights*	LED*2	—
Boot light (Saloon)	5	—
Luggage compartment light (Hatchback)	LED*2	—

*1 UN-R stands for United Nations Regulation.

*2 LED is the abbreviation for Light Emitting Diode.

▼ Tyres

Sample tyre mark and its meaning

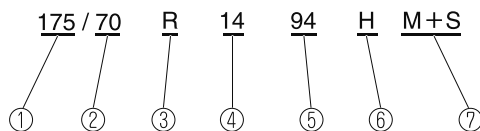

1. Nominal section width
2. Nominal aspect ratio in %
3. Construction code
4. Nominal rim diameter in inches
5. Load index (not on ZR tyres)
6. Speed symbol
7. Mud and snow

Tyre mark information

Choose the proper tyres for your vehicle using the following tyre mark information.

Speed symbol	Maximum permissible speed
Q	Up to 160 km/h (99 mph)
R	Up to 170 km/h (105 mph)
S	Up to 180 km/h (111 mph)
T	Up to 190 km/h (118 mph)
U	Up to 200 km/h (124 mph)
H	Up to 210 km/h (130 mph)
V	Up to 240 km/h (149 mph)
W	Up to 270 km/h (167 mph)
Y	Up to 300 km/h (186 mph)

9-6

*Some models.

Specifications
Specifications

Speed symbol	Maximum permissible speed
ZR	Over 240 km/h (149 mph)

Tyre and inflation pressure

NOTE

The tyres have been optimally matched with the chassis of your vehicle.

When replacing tyres, Mazda recommends that you replace tyres of the same type originally fitted to your vehicle. For details, contact an expert repairer, we recommend an Authorised Mazda Repairer.

Check the tyre pressure label for tyre size and inflation pressure.

- Refer to Tyre Pressure Label on page 9-2.
- Refer to Tyre Inflation Pressure on page 6-28.

Standard tyre

Tyre size		Inflation pressure	
		Up to 3 persons	— Full load
205/60R16 92V	Front	250 kPa (2.5 bar, 36 psi)	260 kPa (2.6 bar, 38 psi)
	Rear	250 kPa (2.5 bar, 36 psi)	290 kPa (2.9 bar, 42 psi)
215/45R18 89W	Front	250 kPa (2.5 bar, 36 psi)	270 kPa (2.7 bar, 39 psi)
	Rear	250 kPa (2.5 bar, 36 psi)	290 kPa (2.9 bar, 42 psi)

1 person's weight: About 75 kg

Temporary spare tyre

Tyre size	Inflation pressure
T125/70D16 96M	420 kPa (4.2 bar, 60 psi)

Wheel nut tightening torque

When installing a tyre, tighten the wheel nut to the following torque.
108—147 N·m (12—14 kgf·m, 80—108 ft·lbf)

▼ **Fuses**

Refer to Fuses on page 6-34.

▼ **Brakes**

If you require information regarding the wear limit specification for the brake disc plates and the measurement method, please contact an expert repairer, we recommend an Authorised Mazda Repairer. The information is made freely available.

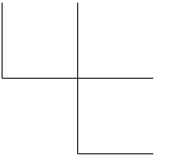
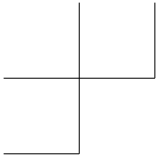

MEMO

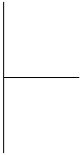

9-8

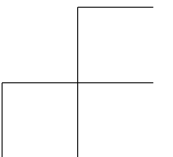
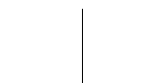
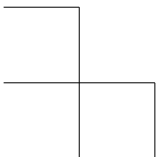

10 Index



Index

A

- Accessory Socket..... 5-36
- Active Driving Display..... 4-35
- Adaptive LED Headlights (ALH)..... 4-90
- Add-On Non-Genuine Parts and Accessories..... 8-2
- Advanced Key
 - Advanced keyless entry system..... 3-8
 - Operational range..... 3-9
- Advanced Keyless Entry System..... 3-8
- Air Bag/Front Seat Belt Pretensioner System Warning Beep..... 7-37
- Air-Conditioning System..... 5-2
 - Fully automatic type..... 5-9
 - Manual type..... 5-5
 - Operating tips..... 5-2
 - Vent operation..... 5-3
- Antilock Brake System (ABS)..... 4-75
- Assist Grips..... 5-39
- AUTOHOLD..... 4-69
- AUTOHOLD Warning Beep..... 7-40
- Automatic Transmission
 - Active Adaptive Shift (AAS)..... 4-42
 - Automatic transmission controls..... 4-39
 - Direct mode..... 4-48
 - Driving tips..... 4-49
 - Manual shift mode..... 4-42
 - Shift-lock system..... 4-40
 - Transmission ranges..... 4-41

B

- Battery..... 6-23
 - Inspecting electrolyte level..... 6-24
 - Maintenance..... 6-24
 - Recharging..... 6-24
 - Replacement..... 6-25
 - Specifications..... 9-3
- Battery Runs Out..... 7-13

10-2

- Jump-starting..... 7-13
- Blind Spot Monitoring (BSM)..... 4-96
 - Cancelling operation of Blind Spot Monitoring (BSM)..... 4-100
- Blind Spot Monitoring (BSM) Warning Beep..... 7-40
- Body Lubrication..... 6-17
- Bonnet Release..... 6-9
- Boot Lid..... 3-17
 - Luggage compartment..... 3-20
 - When liftgate/boot lid cannot be opened..... 7-42
- Boot Light..... 5-33
- Bottle Holder..... 5-38
- Brakes
 - Brake assist..... 4-67
 - Brake override system..... 4-67
 - Electric Parking Brake (EPB)..... 4-64
 - Foot brake..... 4-63
 - Pad wear indicator..... 4-67
 - Parking brake..... 4-64
 - Warning light..... 4-67
- Brake Override System..... 4-67
- Brake Override Warning Beep..... 7-39

C

- Capacities..... 9-4
- Carbon Monoxide..... 3-23
- Cell Phones..... 8-4
- Centre Console..... 5-41
- Child Restraint
 - Categories of child-restraint systems..... 2-35
 - Child-restraint precautions..... 2-31
 - Child-restraint system installation position..... 2-35
 - Child-restraint system suitability for various seat positions table..... 2-40
 - Installing child-restraint systems..... 2-43

Index

- Child Safety Locks for Rear Doors... 3-16
Collision warning..... 7-41
Coming Home Light..... 4-53
Cruise Control..... 4-219
 Cruise standby indication (white)/
 cruise set indication (green)..... 4-219
Cruising & Traffic Support (CTS).....
..... 4-138
 Close proximity warning..... 4-143
 Display indication..... 4-142
 Setting the system..... 4-145
 Shift-up/shift-down request
 display..... 4-153
 Stop hold control..... 4-153
Cup Holder..... 5-37
Cylinder Deactivation..... 4-18
- D**
- Defogger..... 4-60
 Mirror..... 4-60
 Rear window..... 4-60
Dimensions..... 9-5
Direction Indicators..... 4-54
Display..... 4-19
Distance & Speed Alert (DSA)..... 4-108
 Indication on display..... 4-109
Door Locks..... 3-10
Door-ajar Warning Beep..... 7-41
Driver Attention Alert (DAA)..... 4-109
Driver Monitoring Camera..... 4-217
Driver Monitoring (DM)..... 4-111
Drive Selection..... 4-79
Driving In Flooded Area..... 3-44
Driving Tips..... 3-39
 Automatic transmission..... 4-49
 Driving in flooded area..... 3-44
 Floor mat..... 3-41
 Hazardous driving..... 3-40
 Rocking the vehicle..... 3-42
 Running-in period..... 3-39
- Saving fuel and protection of the
environment..... 3-39
 Winter driving..... 3-42
Dynamic Stability Control (DSC)..... 4-77
 DSC OFF indicator light..... 4-78
 DSC OFF switch..... 4-78
 TCS/DSC indicator light..... 4-77
- E**
- Electric Parking Brake (EPB)..... 4-64
Electric Parking Brake (EPB) Warning
Beep..... 7-39
Electronic steering lock warning
beep..... 7-39
Emergency Starting
 Push-starting..... 7-16
 Starting a flooded engine..... 7-16
Emergency Stop Signal System..... 4-73
Emergency Towing
 Towing description..... 7-19
 Towing hooks..... 7-20
Emission Control Maintenance..... 6-41
 Air-intake control system..... 6-41
 Engine..... 6-41
 Evaporative emission control
 system..... 6-42
 Exhaust emission control
 system..... 6-42
 Fuel system..... 6-41
 Ignition system..... 6-42
Emission Control System..... 3-22
Engine
 Bonnet release..... 6-9
 Coolant..... 6-15
 Engine compartment overview.... 6-11
 Exhaust gas..... 3-23
 Oil..... 6-12
 Starting..... 4-5
Essential Information..... 6-2
Excessive Speed Warning..... 7-41

Index

Exhaust Gas..... 3-23
Exterior Care..... 6-43
 Aluminium wheel maintenance... 6-48
 Bright-metal maintenance..... 6-47
 Cavity protection..... 6-47
 Maintaining the finish..... 6-44
 Paint damage touch-up..... 6-47
 Plastic part maintenance..... 6-48
 Undercoating..... 6-47

F

Flasher
 Hazard warning..... 4-61
 Headlights..... 4-50
Flat Tyre..... 7-3
 Changing a flat tyre..... 7-7
 Mounting the spare tyre..... 7-11
 Removing a flat tyre..... 7-8
 Removing a tyre..... 7-8
Floor Mat..... 3-41
Fluids
 Brake/Clutch..... 6-16
 Classification..... 9-4
 Washer..... 6-17
Foot Brake..... 4-63
Forward Sensing Camera (FSC).... 4-206
Front Camera/Side Cameras/Rear
Camera..... 4-216
Front Cross Traffic Alert (FCTA).... 4-113
Front Radar Sensor..... 4-210
Front Side Radar Sensor..... 4-213
Fuel
 Filler flap and cap..... 3-25
 Requirements (Australia)..... 3-21
 Requirements (Except
 Australia)..... 3-22
 Tank capacity..... 9-4
Fuses..... 6-34
 Panel description..... 6-37
 Replacement..... 6-34

10-4

G

Gauges..... 4-19
Glove Compartment..... 5-40

H

Hazardous Driving..... 3-40
Hazard Warning Flasher..... 4-61
Headlights
 Coming home light..... 4-53
 Control..... 4-50
 Flashing..... 4-52
 High-low beam..... 4-52
 Leaving home light..... 4-53
 Levelling..... 4-54
 Running lights..... 4-54
Head Restraint..... 2-18
High Beam Control System
(HBC)..... 4-87
 High Beam Control System (HBC)
 indicator light (green)..... 4-89
Hill Launch Assist (HLA)..... 4-74
Horn..... 4-61

I

If a Warning Light Turns On or
Flashes..... 7-23
If the Active Driving Display Does Not
Operate..... 7-44
Ignition Not Switched Off (STOP)
Warning Beep..... 7-38
Illuminated Entry System..... 5-35
Immobilizer System..... 3-37
Inspecting Brake/Clutch Fluid
Level..... 6-16
Inspecting Coolant Level..... 6-15
Inspecting Engine Oil Level..... 6-14
Inspecting Washer Fluid Level..... 6-17
Instrument Cluster..... 4-19
 Average fuel economy..... 4-27

Index

- Current fuel economy.....4-27
- Distance-to-empty..... 4-26
- Engine coolant temperature gauge.....4-24
- Fuel gauge..... 4-24
- Indication/indicator lights.....4-32
- Instrument panel illumination.....4-25
- i-ACTIVSENSE display.....4-28
- Message indicated on multi-information display.....7-34
- Multi-information display..... 4-21
- Odometer..... 4-23
- Outside temperature display..... 4-26
- Speedometer..... 4-19
- Tachometer..... 4-20
- Trip meter..... 4-23
- Vehicle speed alarm.....4-27
- Warning indication/warning lights..... 4-30
- Warning (display indication)..... 4-28
- Intelligent Speed Assistance (ISA).....4-158
 - Activation/deactivation.....4-161
 - Intelligent Speed Assistance (ISA) display.....4-161
 - Intelligent Speed Assistance (ISA) main indication (white)..... 4-160
 - Intelligent Speed Assistance (ISA) set indication (green)..... 4-160
 - Setting the system..... 4-162
 - Temporarily cancelling the system..... 4-163
- Interior Care..... 6-49
 - Active driving display maintenance..... 6-51
 - Cleaning the window interiors.....6-51
 - Instrument panel top (Soft pad) maintenance..... 6-51
 - Leather upholstery maintenance..... 6-50
 - Panel maintenance..... 6-51
 - Plastic part maintenance.....6-50
 - Seat belt maintenance.....6-49
 - Upholstery maintenance..... 6-50
 - Vinyl upholstery maintenance..... 6-50
- Interior Lights..... 5-33
 - Boot light.....5-33
 - Luggage compartment light.....5-33
 - Map lights.....5-33
 - Overhead lights.....5-33
- i-ACTIVSENSE..... 4-82
 - Active safety technology..... 4-82
 - Adaptive LED Headlights (ALH)..... 4-90
 - Blind Spot Monitoring (BSM).....4-96
 - Camera and sensors.....4-83
 - Cruising & Traffic Support (CTS)..... 4-138
 - Distance & Speed Alert (DSA).....4-108
 - Driver Attention Alert (DAA)..... 4-109
 - Driver monitoring camera..... 4-217
 - Driver Monitoring (DM)..... 4-111
 - Forward Sensing Camera (FSC)..... 4-206
 - Front camera/side cameras/rear camera.....4-216
 - Front Cross Traffic Alert (FCTA).....4-113
 - Front radar sensor.....4-210
 - Front side radar sensor..... 4-213
 - High Beam Control System (HBC)..... 4-87
 - Intelligent Speed Assistance (ISA)..... 4-158
 - i-ACTIVSENSE status symbol (warning/risk avoidance support system).....4-84
 - i-ACTIVSENSE switch.....4-85
 - Lane Departure Warning System (LDWS)..... 4-92

Index

Lane-keep Assist System (LAS)..... 4-154
Mazda Radar Cruise Control with Stop & Go function (MRCC with Stop & Go function)..... 4-128
Mazda Radar Cruise Control (MRCC)..... 4-120
Pre-crash safety technology..... 4-83
Rear Cross Traffic Alert (RCTA)..... 4-116
Rear side radar sensor..... 4-214
Smart Brake Support (SBS)..... 4-164
Smart Brake Support [Rear Crossing] (SBS-RC)..... 4-170
Smart Brake Support [Rear] (SBS-R)..... 4-166
Traffic Sign Recognition System (TSR)..... 4-101
Ultrasonic sensor..... 4-216
360°view monitor..... 4-175
i-stop..... 4-11
 Indicator light (Green)..... 4-17
 i-stop OFF switch..... 4-15
 Vehicle roll prevention function..... 4-15
 Warning light (Amber)..... 4-17
i-stop warning beep..... 7-39

J

Jack..... 7-3
Jump-Starting..... 7-13

K

Keyless Entry System..... 3-4
Keys..... 3-2
 Key suspend function..... 3-7
 Transmitter..... 3-5
Key Left-in-boot Warning Beep (With the advanced keyless function)..... 7-38

Key Left-in-luggage Compartment Warning beep (With the advanced keyless function)..... 7-38
Key Left-in-vehicle Warning Beep (With the advanced keyless function)..... 7-39
Key Removed from Vehicle Warning Beep..... 7-38
Key Suspend Function..... 3-7

L

Label Information

 Built date..... 9-2
 Chassis number..... 9-2
 Engine number..... 9-2
 Model plate..... 9-2
 Tyre pressure label..... 9-2
 Vehicle identification number..... 9-2
Lane Departure Warning sound..... 7-40
Lane Departure Warning System (LDWS)..... 4-92
Lane-change Signals..... 4-55
Lane-keep Assist System (LAS)..... 4-154
Leaving Home Light..... 4-53
Liftgate..... 3-17
 Luggage compartment..... 3-20
 When liftgate/boot lid cannot be opened..... 7-42
Liftgate/Boot Lid
 Luggage compartment..... 3-20
Lighting Control..... 4-50
Lights-on Reminder..... 7-37
Light Bulbs
 Replacement..... 6-31
 Specifications..... 9-5
Low Fuel Warning Beep..... 7-39
Lubricant Quality..... 9-4
Luggage Compartment..... 5-41
 Cargo Securing Loops..... 5-41
 Shopping Bag Hook..... 5-41
Luggage Compartment Light..... 5-33

Index

M

- Maintenance
 - Information..... 6-2
 - Scheduled.....6-3
- Manual Transmission Shift Pattern... 4-37
- Map Lights..... 5-33
- Mazda Radar Cruise Control with Stop & Go function (MRCC with Stop & Go function)..... 4-128
 - Close proximity warning..... 4-131
 - Display indication.....4-130
 - Setting the system..... 4-133
 - Stop hold control..... 4-137
- Mazda Radar Cruise Control with Stop & Go function (MRCC with Stop & Go function) System Warnings..... 7-41
- Mazda Radar Cruise Control (MRCC).....4-120
 - Close proximity warning.....4-122
 - Display indication.....4-121
 - Setting the system..... 4-124
 - Shift-up/shift-down request display.....4-128
- Mazda Radar Cruise Control (MRCC) System Warnings..... 7-40
- Message Indicated on Multi-information Display..... 7-34
- Meters..... 4-19
- Mirrors
 - Outside mirrors.....3-27
 - Rearview mirror..... 3-29
- Mirror Defogger.....4-60
- Multi-information Display..... 4-21
- MZD Connect..... 5-14
 - Appendix..... 5-26
 - MZD Connect Basic Operations.....5-17

O

- Outside Mirrors..... 3-27
- Overhead Console..... 5-40
- Overhead Lights..... 5-33
- Overheating..... 7-17
- Owner Maintenance
 - Closing the bonnet.....6-10
 - Engine compartment overview.... 6-11
 - Key battery replacement.....6-25
 - Opening the bonnet..... 6-9
 - Owner maintenance precautions....6-8

P

- Parking Brake.....4-64
- Parking Sensor System..... 4-236
 - Park assist sensor system operation..... 4-240
 - Sensor detection range..... 4-238
- Power Steering..... 4-81
- Power Windows..... 3-31

R

- Rearview Mirror.....3-29
- Rear Coat Hooks.....5-39
- Rear Cross Traffic Alert (RCTA).... 4-116
- Rear Door Child Safety Locks.....3-16
- Rear Side Radar Sensor..... 4-214
- Rear View Monitor..... 4-227
 - Displayable range on the screen..... 4-229
 - Rear view monitor operation.... 4-231
 - Rear view parking camera location..... 4-228
 - Switching to the rear view monitor display.....4-228
 - Variance between actual road conditions and displayed image..... 4-234
 - Viewing the display.....4-230

Index

Rear Window Defogger..... 4-60
Rear Window Washer..... 4-59
Rear Window Wiper..... 4-59
Recommended Oil.....6-13
Recording of Vehicle Data.....8-5
Registering Your Vehicle in A Foreign
Country.....8-2
Replacement
 Fuse.....6-34
 Key battery..... 6-25
 Light bulbs.....6-31
 Tyres..... 6-29
 Wheel.....6-30
 Wiper..... 6-18
Rocking the Vehicle..... 3-42
Running-In Period.....3-39

S

Saving Fuel and Protection of the
Environment..... 3-39
Scheduled Maintenance..... 6-3
Seats
 Driver's seat.....2-5
 Driving position memory..... 2-11
 Front passenger's seat.....2-13
 Front seat.....2-5
 Head restraint..... 2-18
 Rear seat.....2-14
 Seat warmer.....2-20
Seat Belt System
 Automatic locking..... 2-26
 Emergency locking.....2-25
 Pregnant women.....2-25
 Seat belt precautions..... 2-23
Seat Belt Warning Beep..... 7-37
Security System
 Immobilizer system..... 3-37
Smart Brake Support (SBS)..... 4-164
 Collision warning..... 4-165

 Stopping the Smart Brake Support
 (SBS) system operation..... 4-166
Smart Brake Support [Rear Crossing]
(SBS-RC)..... 4-170
 Collision warning..... 4-174
 Stopping the Smart Brake Support
 [Rear Crossing] (SBS-RC) system
 operation..... 4-174
Smart Brake Support [Rear] (SBS-
R)..... 4-166
 Collision warning..... 4-169
 Stopping the Smart Brake Support
 [Rear] (SBS-R) system
 operation..... 4-170
Spare Tyre..... 7-5
Spare Tyre and Tool Storage.....7-3
Specifications
 Brakes.....9-7
 Capacities.....9-4
 Dimensions.....9-5
 Electrical system.....9-3
 Engine.....9-3
 Light bulbs.....9-5
 Lubricant quality..... 9-4
Speed Limiter Warning Beep..... 7-41
SRS Air Bags
 Front passenger air bag deactivation
 switch.....2-56
 How the SRS air bags work..... 2-59
 Limitations to SRS air bag..... 2-64
 Monitoring.....2-65
 SRS air bag deployment
 criteria.....2-62
 Supplementary restraint system
 components.....2-58
 Supplementary restraint system
 (SRS) precautions.....2-51
Starting the Engine.....4-5
Steering Wheel
 Heated steering wheel..... 2-21
 Horn.....4-61

Index

- Storage Compartments.....5-40
 Centre console.....5-41
 Glove compartment.....5-40
 Luggage Compartment.....5-41
 Overhead console.....5-40
 Storage pocket.....5-40
Storage Pocket.....5-40
Sunroof.....3-34
Sunshade.....3-36
Sunvisors.....5-32
- T**
- Three-flash Turn Signal.....4-55
Touch Sensor Inoperable Warning Beep
(With the advanced keyless
function).....7-38
Towing
 Hook.....7-20
 Towing caravans and trailers.....3-45
Towing Description.....7-19
Traction Control System (TCS).....4-76
 TCS/DSC indicator light.....4-76
Traffic Sign Recognition System
(TSR).....4-101
Transmitter.....3-5
Trouble
 Battery runs out.....7-13
 Emergency starting.....7-16
 Emergency towing.....7-19
 Flat tyre.....7-3
 Overheating.....7-17
 Parking in an emergency.....7-2
 Warning/indicator lights and warning
 sounds.....7-23
 When liftgate/boot lid cannot be
 opened.....7-42
Turn and Lane-Change Signals.....4-54
Tyres.....6-28
 Flat tyre.....7-3
 Replacing a tyre.....6-29
 Replacing a wheel.....6-30
 Snow tyres.....3-43
 Specifications.....9-6
 Temporary spare tyre.....6-30
 Tyre chains.....3-43
 Tyre inflation pressure.....6-28
 Tyre rotation.....6-29
Tyre Pressure Monitoring System...4-223
- U**
- Ultrasonic Sensor.....4-216
- V**
- Vanity Mirrors.....5-32
Vehicle Information Labels
 Built date.....9-2
 Chassis number.....9-2
 Engine number.....9-2
 Model plate.....9-2
 Tyre pressure label.....9-2
 Vehicle identification number.....9-2
Vehicle Problem Warning Beep.....7-39
Vehicle Speed Alarm.....7-40
- W**
- Warning Sound is Activated.....7-37
 Air bag/front seat belt pretensioner
 system warning beep.....7-37
 AUTOHOLD Warning Beep.....7-40
 Blind Spot Monitoring (BSM)
 warning beep.....7-40
 Brake override warning beep.....7-39
 Collision warning.....7-41
 Door-ajar warning beep.....7-41
 Electric Parking Brake (EPB)
 Warning Beep.....7-39
 Electronic steering lock warning
 beep.....7-39
 Excessive speed warning.....7-41

Index

Ignition not switched off (STOP) warning beep.....	7-38
i-stop warning beep.....	7-39
Key left-in-boot warning beep (With the advanced keyless function)....	7-38
Key left-in-luggage compartment warning beep (With the advanced keyless function).....	7-38
Key left-in-vehicle warning beep (With the advanced keyless function).....	7-39
Key removed from vehicle warning beep.....	7-38
Lane Departure Warning sound...	7-40
Lights-on reminder.....	7-37
Low fuel warning beep.....	7-39
Mazda Radar Cruise Control with Stop & Go function (MRCC with Stop & Go function) system warnings.....	7-41
Mazda Radar Cruise Control (MRCC) system warnings.....	7-40
Seat belt warning beep.....	7-37
Speed limiter warning beep.....	7-41
Touch sensor inoperable warning beep (With the advanced keyless function).....	7-38
Vehicle problem warning beep....	7-39
Vehicle speed alarm.....	7-40
Warranty.....	8-2
Registering Your Vehicle in A Foreign Country.....	8-2
Windows	
Power windows.....	3-31
Windscreen Washer.....	4-58
Windscreen Wipers.....	4-56
Windscreen Wipers Operate at High Speed.....	7-45
Winter Driving.....	3-42
Wiper	
Replacing Rear Window Wiper Blade (Hatchback).....	6-21
Replacing windscreen wiper blades.....	6-18
0-9	
360°View Monitor.....	4-175
Front wide view.....	4-189
How to use the system.....	4-182
Margin of error between road surface on screen and actual road surface.....	4-199
Rear wide view.....	4-198
Side view.....	4-190
Top view/Front view.....	4-186
Top view/Rear view.....	4-193
Types of images displayed on the screen.....	4-179

